



RFMD Green, RoHS Compliant, Pb-Free (Z Part Number)  
Package: SOT-86

**Product Description**

The SGA-6386 is a high performance SiGe HBT MMIC Amplifier. A Darlington configuration featuring one-micron emitters provides high  $F_T$  and excellent thermal performance. The heterojunction increases breakdown voltage and minimizes leakage current between junctions. Cancellation of emitter junction non-linearities results in higher suppression of intermodulation products. Only two DC-blocking capacitors, a bias resistor, and an optional RF choke are required for operation.

**Features**

- Broadband Operation: DC to 5000MHz
- Cascadable 50Ω
- Operates from Single Supply
- Low Thermal Resistance Package

**Applications**

- PA Driver Amplifier
- Cellular, PCS, GSM, UMTS
- IF Amplifier
- Wireless Data, Satellite

**Optimum Technology Matching® Applied**

- GaAs HBT
- GaAs MESFET
- InGaP HBT
- SiGe BiCMOS
- Si BiCMOS
- SiGe HBT
- GaAs pHEMT
- Si CMOS
- Si BJT
- GaN HEMT
- RF MEMS

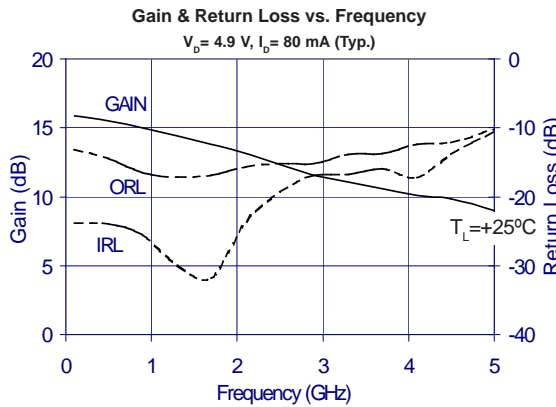

| Parameter                            | Specification |      |      | Unit | Condition |
|--------------------------------------|---------------|------|------|------|-----------|
|                                      | Min.          | Typ. | Max. |      |           |
| Small Signal Gain                    | 14.0          | 15.4 | 16.9 | dB   | 850MHz    |
|                                      |               | 13.5 |      | dB   | 1950MHz   |
|                                      |               | 12.5 |      | dB   | 2400MHz   |
| Output Power at 1dB Compression      |               | 21.0 |      | dBm  | 850MHz    |
|                                      |               | 19.0 |      | dBm  | 1950MHz   |
| Output Third Intercept Point         |               | 36.0 |      | dBm  | 850MHz    |
|                                      |               | 34.0 |      | dBm  | 1950MHz   |
| Bandwidth Determined by Return Loss  |               | 5000 |      | MHz  | >10dB     |
| Input Return Loss                    |               | 26.7 |      | dB   | 1950MHz   |
| Output Return Loss                   |               | 16.2 |      | dB   | 1950MHz   |
| Noise Figure                         |               | 4.0  |      | dB   | 1950MHz   |
| Device Operating Voltage             | 4.6           | 4.9  | 5.4  | V    |           |
| Device Operating Current             | 72            | 80   | 88   | mA   |           |
| Thermal Resistance (Junction - Lead) |               | 97   |      | °C/W |           |

Test Conditions:  $V_S=8V$ ,  $I_D=80mA$  Typ.,  $OIP_3$  Tone Spacing = 1MHz,  $P_{OUT}$  per tone = 0dBm,  $R_{BIAS}=39\Omega$ ,  $T_L=25^\circ C$ ,  $Z_S=Z_L=50\Omega$

## Absolute Maximum Ratings

| Parameter                      | Rating     | Unit |
|--------------------------------|------------|------|
| Max Device Current ( $I_D$ )   | 160        | mA   |
| Max Device Voltage ( $V_D$ )   | 7          | V    |
| Max RF Input Power             | +18        | dBm  |
| Max Junction Temp ( $T_J$ )    | +150       | °C   |
| Operating Temp Range ( $T_L$ ) | -40 to +85 | °C   |
| Max Storage Temp               | +150       | °C   |



**Caution!** ESD sensitive device.

Exceeding any one or a combination of the Absolute Maximum Rating conditions may cause permanent damage to the device. Extended application of Absolute Maximum Rating conditions to the device may reduce device reliability. Specified typical performance or functional operation of the device under Absolute Maximum Rating conditions is not implied.

RoHS status based on EU Directive 2002/95/EC (at time of this document revision).

The information in this publication is believed to be accurate and reliable. However, no responsibility is assumed by RF Micro Devices, Inc. ("RFMD") for its use, nor for any infringement of patents, or other rights of third parties, resulting from its use. No license is granted by implication or otherwise under any patent or patent rights of RFMD. RFMD reserves the right to change component circuitry, recommended application circuitry and specifications at any time without prior notice.

Operation of this device beyond any one of these limits may cause permanent damage. For reliable continuous operation, the device voltage and current must not exceed the maximum operating values specified in the table on page one.

Bias Conditions should also satisfy the following expression:

$$I_D V_D < (T_J - T_L) / R_{TH, J-I}$$

## Typical Performance at Key Operating Frequencies

| Parameter                          | Unit | 100 MHz | 500 MHz | 850 MHz | 1950 MHz | 2400 MHz | 3500 MHz |
|------------------------------------|------|---------|---------|---------|----------|----------|----------|
| Small Signal Gain                  | dB   | 15.9    | 15.5    | 15.4    | 13.5     | 12.5     | 10.7     |
| Output Third Order Intercept Point | dBm  | 37.1    | 37.1    | 36.0    | 34.0     | 32.2     | 27.9     |
| Output Power at 1dB Compression    | dBm  | 20.2    | 20.5    | 21.0    | 19.0     | 18.6     | 16.3     |
| Input Return Loss                  | dB   | 23.8    | 23.9    | 25.6    | 26.7     | 20.4     | 16.0     |
| Output Return Loss                 | dB   | 13.2    | 14.5    | 16.6    | 16.2     | 15.1     | 14.2     |
| Reverse Isolation                  | dB   | 20.0    | 20.2    | 20.4    | 19.9     | 19.2     | 17.2     |
| Noise Figure                       | dB   | 3.7     | 3.4     | 3.6     | 4.0      | 4.2      | 4.6      |

Test Conditions:  $V_S = 8V$ ,  $I_D = 80mA$  Typ.,  $OIP_3$  Tone Spacing = 1MHz,  $P_{OUT}$  per tone = 0dBm,  $R_{BIAS} = 39\Omega$ ,  $T_L = 25^\circ C$ ,  $Z_S = Z_L = 50\Omega$

**$OIP_3$  vs. Frequency**  
 $V_D = 4.9V$ ,  $I_D = 80mA$

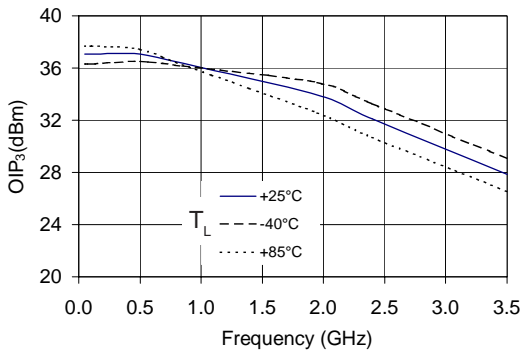

**$P_{1dB}$  vs. Frequency**  
 $V_D = 4.9V$ ,  $I_D = 80mA$

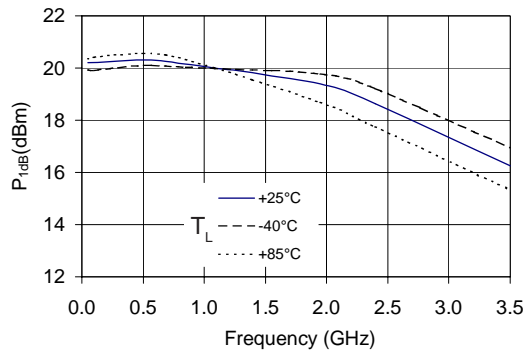

**Noise Figure vs. Frequency**  
 $V_D = 4.9V$ ,  $I_D = 80mA$

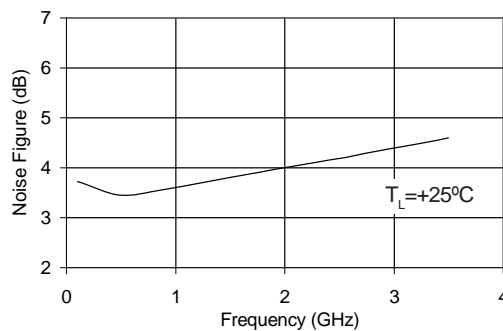

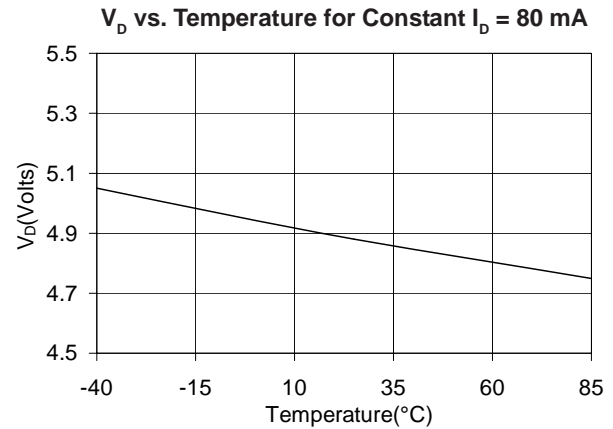
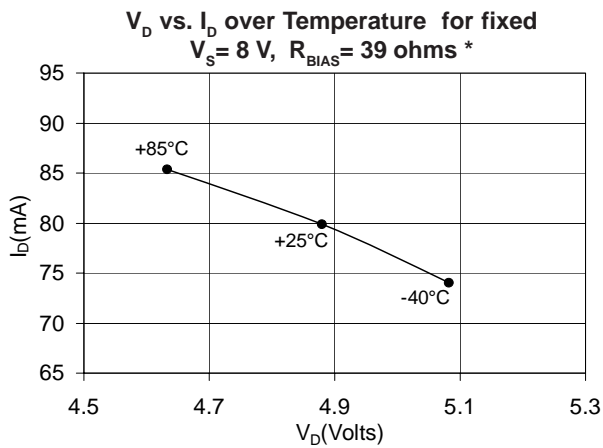
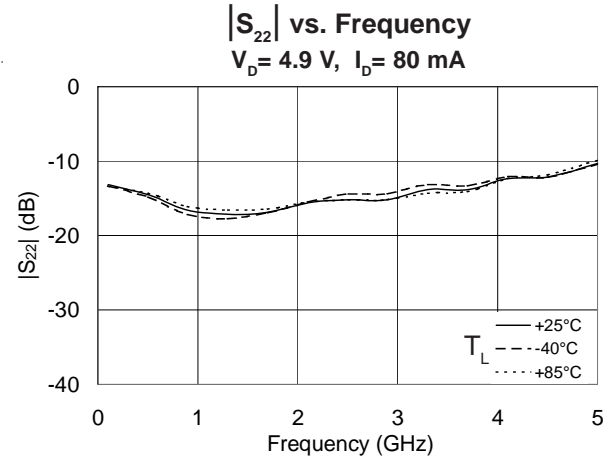
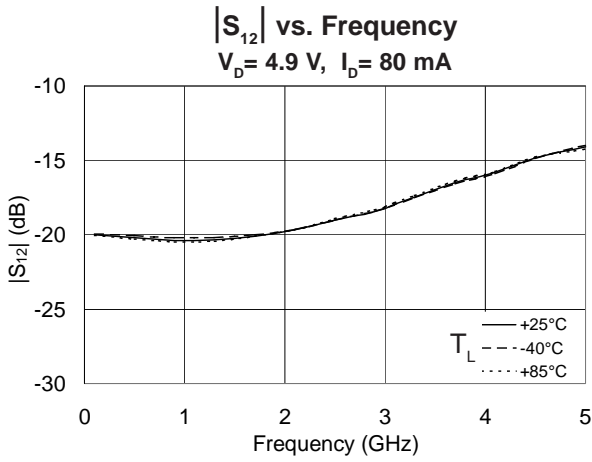
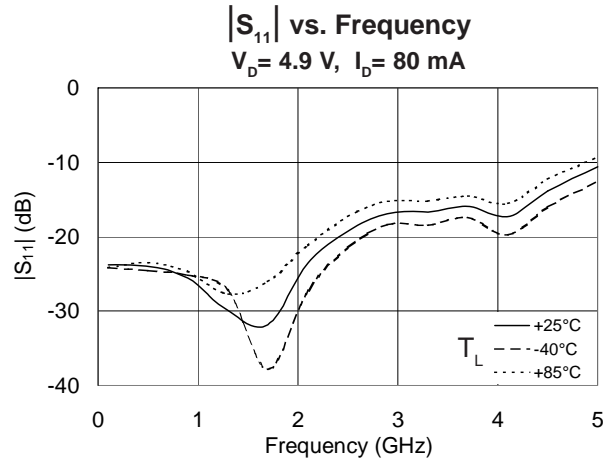
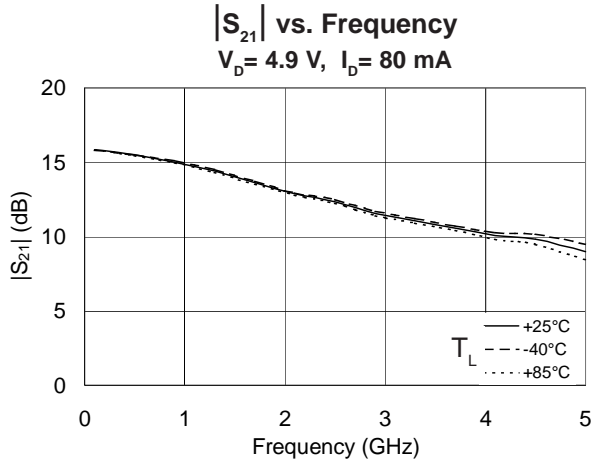

\* Note: In the applications circuit on page 4,  $R_{BIAS}$  compensates for voltage and current variation over temperature.

| Pin  | Function    | Description   |
|------|-------------|---|
| 1    | RF IN       | RF input pin. This pin requires the use of an external DC-blocking capacitor chosen for the frequency of operation.             |
| 2, 4 | GND         | Connection to ground. For optimum RF performance use via holes as close to ground leads as possible to reduce lead inductance.  |
| 3    | RF OUT/BIAS | RF output and bias pin. DC voltage is present on this pin, therefore a DC-blocking capacitor is necessary for proper operation. |

## Application Schematic

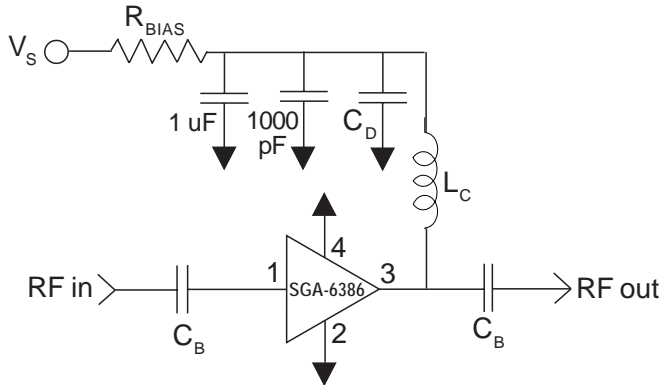

| Reference Designator | Frequency (Mhz) |        |       |       |       |
|----------------------|-----------------|--------|-------|-------|-------|
|                      | 500             | 850    | 1950  | 2400  | 3500  |
| C <sub>B</sub>       | 220 pF          | 100 pF | 68 pF | 56 pF | 39 pF |
| C <sub>D</sub>       | 100 pF          | 68 pF  | 22 pF | 22 pF | 15 pF |
| L <sub>C</sub>       | 68 nH           | 33 nH  | 22 nH | 18 nH | 15 nH |

| Recommended Bias Resistor Values for I <sub>D</sub> =80mA |      |      |      |      |
|---|------|------|------|------|
| $R_{BIAS} = (V_S - V_D) / I_D$                            |      |      |      |      |
| Supply Voltage (V <sub>S</sub> )                          | 6 V  | 8 V  | 10 V | 12 V |
| R <sub>BIAS</sub>   | 13 Ω | 39 Ω | 62 Ω | 91 Ω |

Note: R<sub>BIAS</sub> provides DC bias stability over temperature.

## Evaluation Board Layout

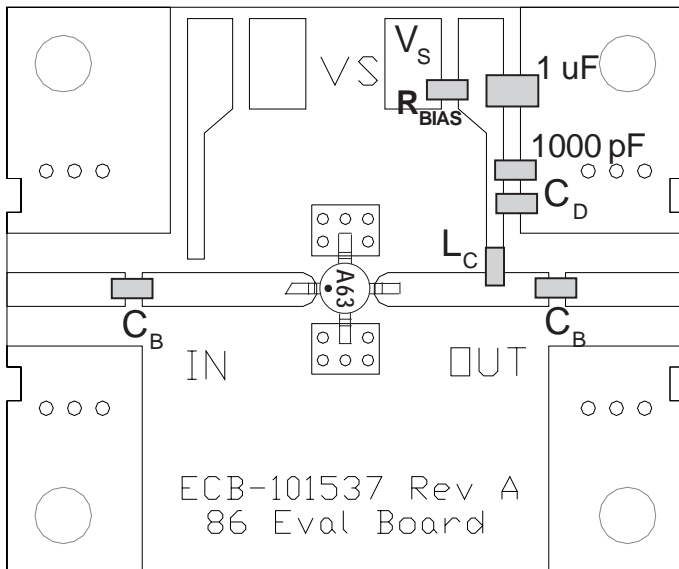

### Mounting Instructions

1. Use a large ground pad area under device pins 2 and 4 with many plated through-holes as shown.
3. We recommend 1 or 2 ounce copper. Measurements for this data sheet were made on a 31 mil thick FR-4 board with 1 ounce copper on both sides.

**Suggested Pad Layout**

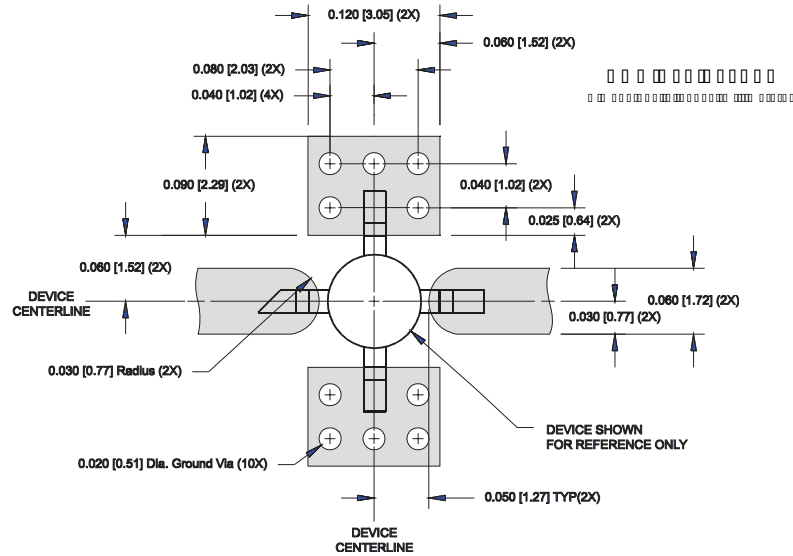

**Package Drawing**

Dimensions in inches (millimeters)  
Refer to drawing posted at [www.rfmd.com](http://www.rfmd.com) for tolerances.

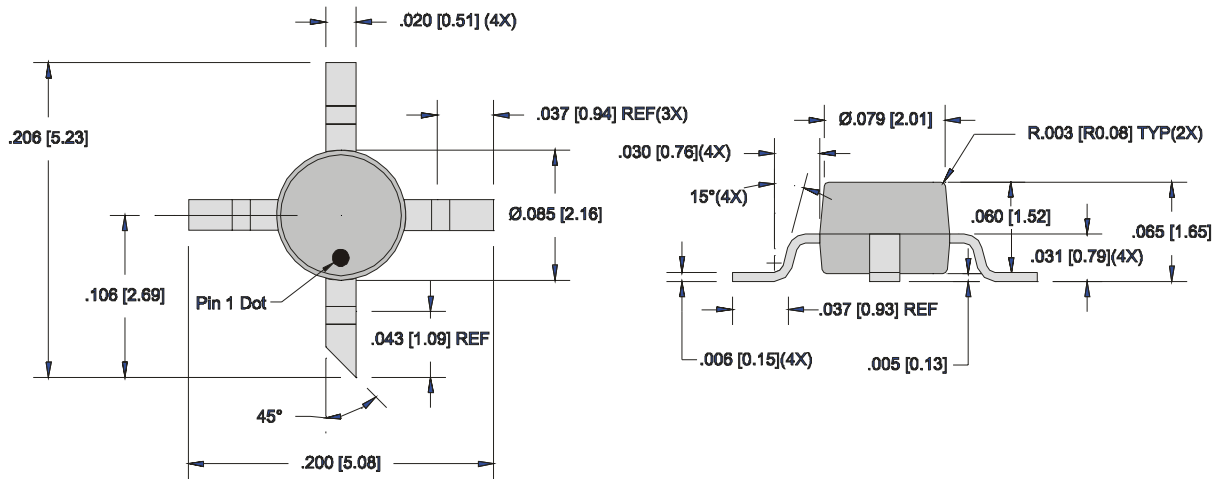

### Part Identification

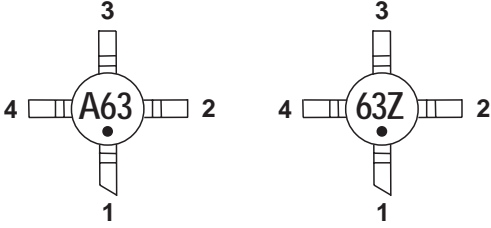

### Ordering Information

| Part Number | Reel Size | Devices/Reel |
|-------------|-----------|--------------|
| SGA-6386    | 13"       | 3000         |
| SGA-6386Z   | 13"       | 3000         |