

## 0.4-GHz TO 4-GHz QUADRATURE MODULATOR

 Check for Samples: [TRF370317](#)

### FEATURES

- 76-dBc Single-Carrier WCDMA ACPR at –8 dBm Channel Power
- Low Noise Floor: –163 dBm/Hz
- OIP3 of 26.5 dBm
- P1dB of 12 dBm
- Unadjusted Carrier Feedthrough of –40 dBm
- Unadjusted Side-Band Suppression of –45 dBc
- Single Supply: 4.5-V–5.5-V Operation
- Silicon Germanium Technology
- 1.7-V CM at I, Q Baseband Inputs

### APPLICATIONS

- Cellular Base Station Transceiver
- CDMA: IS95, UMTS, CDMA2000, TD-SCDMA
- TDMA: GSM, IS-136, EDGE/UWC-136
- Multicarrier GSM
- WiMAX: 802.16d/e
- 3GPP: LTE
- Wireless MAN Wideband Transceivers

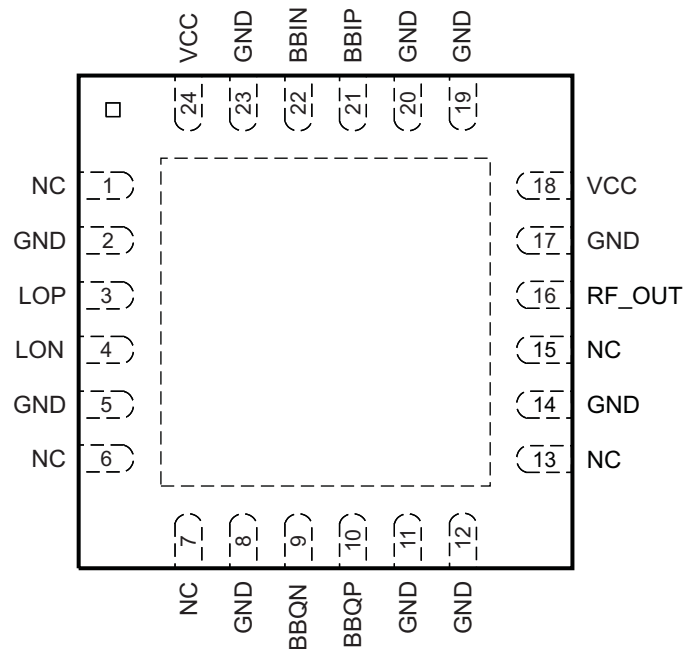
 RGE PACKAGE  
(TOP VIEW)

P0024-04

### DESCRIPTION

The TRF370317 is a low-noise direct quadrature modulator, capable of converting complex modulated signals from baseband or IF directly up to RF. The TRF370317 is a high-performance, superior-linearity device that is ideal to RF frequencies of 400 MHz through 4 GHz. The modulator is implemented as a double-balanced mixer. The RF output block consists of a differential to single-ended converter and an RF amplifier capable of driving a single-ended 50-Ω load without any need of external components. The TRF370317 requires a 1.7-V common-mode voltage for optimum linearity performance.



Please be aware that an important notice concerning availability, standard warranty, and use in critical applications of Texas Instruments semiconductor products and disclaimers thereto appears at the end of this data sheet.

All trademarks are the property of their respective owners.



This integrated circuit can be damaged by ESD. Texas Instruments recommends that all integrated circuits be handled with appropriate precautions. Failure to observe proper handling and installation procedures can cause damage.

ESD damage can range from subtle performance degradation to complete device failure. Precision integrated circuits may be more susceptible to damage because very small parametric changes could cause the device not to meet its published specifications.

**Functional Block Diagram**

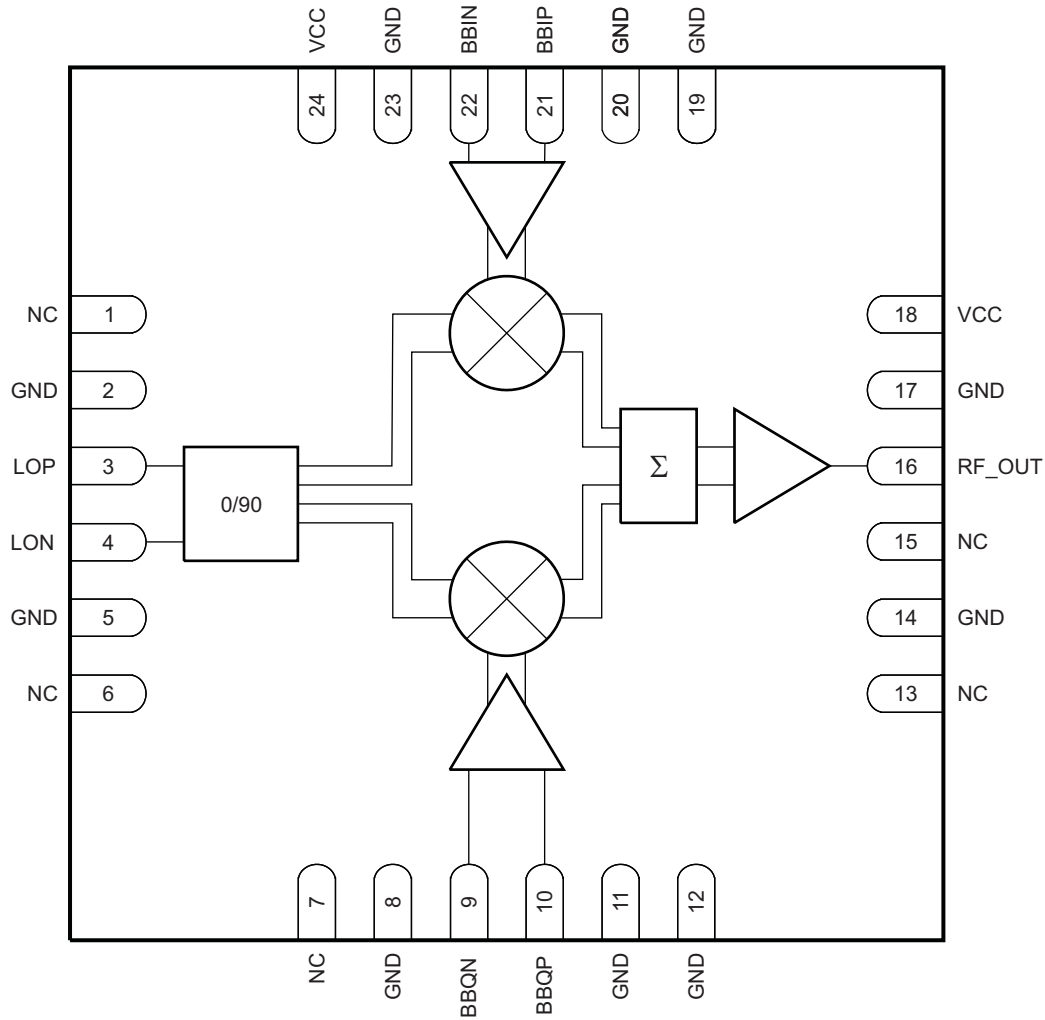

B0175-01

NOTE: NC = No connection

## DEVICE INFORMATION

### TERMINAL FUNCTIONS

TERMINAL		I/O	DESCRIPTION
NAME	NO.		
BBIN	22	I	In-phase negative input
BBIP	21	I	In-phase positive input
BBQN	9	I	Quadrature-phase negative input
BBQP	10	I	Quadrature-phase positive input
GND	2, 5, 8, 11, 12, 14, 17, 19, 20, 23	–	Ground
LON	4	I	Local oscillator negative input
LOP	3	I	Local oscillator positive input
NC	1, 6, 7, 13, 15	–	No connect
RF_OUT	16	O	RF output
VCC	18, 24	–	Power supply

### ABSOLUTE MAXIMUM RATINGS<sup>(1)</sup>

over operating free-air temperature range (unless otherwise noted)

		VALUE <sup>(2)</sup>	UNIT	
Supply voltage range		–0.3 V to 6	V	
T <sub>J</sub>	Operating virtual junction temperature range	–40 to 150	°C	
T <sub>A</sub>	Operating ambient temperature range	–40 to 85	°C	
T <sub>stg</sub>	Storage temperature range	–65 to 150	°C	
ESD	Electrostatic discharge ratings	Human body model (HBM)	75	V
		Charged device model (CDM)	75	V

(1) Stresses beyond those listed under *Absolute Maximum Ratings* may cause permanent damage to the device. These are stress ratings only, and functional operation of the device at these or any other conditions beyond those indicated under *Recommended Operating Conditions* is not implied. Exposure to absolute-maximum-rated conditions for extended periods may affect device reliability.

(2) All voltage values are with respect to network ground terminal.

### RECOMMENDED OPERATING CONDITIONS

over operating free-air temperature range (unless otherwise noted)

		MIN	NOM	MAX	UNIT
V <sub>CC</sub>	Power-supply voltage	4.5	5	5.5	V

### THERMAL CHARACTERISTICS

PARAMETER	TEST CONDITIONS	VALUE	UNIT
R <sub>θJA</sub>	Thermal resistance, junction-to-ambient High-K board, still air	29.4	°C/W
R <sub>θJC</sub>	Thermal resistance, junction-to-case	18.6	°C/W

## ELECTRICAL CHARACTERISTICS

over operating free-air temperature range (unless otherwise noted)

PARAMETER		TEST CONDITIONS	MIN	TYP	MAX	UNIT
<b>DC Parameters</b>						
$I_{CC}$	Total supply current (1.7 V CM)	$T_A = 25^\circ\text{C}$		205	245	mA
<b>LO Input (50-<math>\Omega</math>, Single-Ended)</b>						
$f_{LO}$	LO frequency range		0.4		4	GHz
	LO input power		-5	0	12	dBm
	LO port return loss			15		dB
<b>Baseband Inputs</b>						
$V_{CM}$	I and Q input dc common voltage			1.7		
BW	1-dB input frequency bandwidth		350			MHz
$Z_{I(\text{single ended})}$	Input impedance, resistance			5		k $\Omega$
	Input impedance, parallel capacitance			3		pF

## ELECTRICAL CHARACTERISTICS

over recommended operating conditions, power supply = 5 V,  $T_A = 25^\circ\text{C}$ ,  $V_{CM} = 1.7$  V,  $f_{LO} = 400$  MHz at 8 dBm,  $V_{inBB} = 98$  mVrms single-ended in quadrature,  $f_{BB} = 50$  kHz (unless otherwise noted)

<b>RF Output Parameters</b>						
PARAMETER		TEST CONDITIONS	MIN	TYP	MAX	UNIT
G	Voltage gain	Output rms voltage over input I (or Q) rms voltage		-1.9		dB
P1dB	Output compression point			11		dBm
IP3	Output IP3	$f_{BB} = 4.5, 5.5$ MHz		24.5		dBm
IP2	Output IP2	$f_{BB} = 4.5, 5.5$ MHz		68		dBm
	Carrier feedthrough	Unadjusted		-38		dBm
	Sideband suppression	Unadjusted		-40		dBc

## ELECTRICAL CHARACTERISTICS

over recommended operating conditions, power supply = 5 V,  $T_A = 25^\circ\text{C}$ ,  $V_{CM} = 1.7\text{ V}$ ,  $f_{LO} = 945.6\text{ MHz}$  at 8 dBm,  $V_{inBB} = 98\text{ mVrms}$  single-ended in quadrature,  $f_{BB} = 50\text{ kHz}$  (unless otherwise noted)

RF Output Parameters						
	PARAMETER	TEST CONDITIONS	MIN	TYP	MAX	UNIT
G	Voltage gain	Output rms voltage over input I (or Q) rms voltage		-2.5		dB
P1dB	Output compression point			11		dBm
IP3	Output IP3	$f_{BB} = 4.5, 5.5\text{ MHz}$		25		dBm
IP2	Output IP2	$f_{BB} = 4.5, 5.5\text{ MHz}$		65		dBm
	Carrier feedthrough	Unadjusted		-40		dBm
	Sideband suppression	Unadjusted		-42		dBc
	Output return loss			9		dB
	Output noise floor	$\geq 13\text{ MHz}$ offset from $f_{LO}$ ; $P_{out} = -5\text{ dBm}$		-163		dBm/Hz
EVM	Error vector magnitude (rms)	1 EDGE signal, $P_{out} = -5\text{ dBm}^{(1)}$		0.64%		

(1) The contribution from the source of about 0.28% is not de-embedded from the measurement.

## ELECTRICAL CHARACTERISTICS

over recommended operating conditions, power supply = 5 V,  $T_A = 25^\circ\text{C}$ ,  $V_{CM} = 1.7\text{ V}$ ,  $f_{LO} = 1800\text{ MHz}$  at 8 dBm,  $V_{inBB} = 98\text{ mVrms}$  single-ended in quadrature,  $f_{BB} = 50\text{ kHz}$  (unless otherwise noted)

RF Output Parameters						
	PARAMETER	TEST CONDITIONS	MIN	TYP	MAX	UNIT
G	Voltage gain	Output rms voltage over input I (or Q) rms voltage		-2.5		dB
P1dB	Output compression point			12		dBm
IP3	Output IP3	$f_{BB} = 4.5, 5.5\text{ MHz}$		26		dBm
IP2	Output IP2	$f_{BB} = 4.5, 5.5\text{ MHz}$		60		dBm
	Carrier feedthrough	Unadjusted		-40		dBm
	Sideband suppression	Unadjusted		-50		dBc
	Output return loss			8		dB
	Output noise floor	$\geq 13\text{ MHz}$ offset from $f_{LO}$ ; $P_{out} = -5\text{ dBm}$		-162		dBm/Hz
EVM	Error vector magnitude (rms)	1 EDGE signal, $P_{out} = -5\text{ dBm}^{(1)}$		0.41%		

(1) The contribution from the source of about 0.28% is not de-embedded from the measurement.

## ELECTRICAL CHARACTERISTICS

over recommended operating conditions, power supply = 5 V,  $T_A = 25^\circ\text{C}$ ,  $V_{CM} = 1.7\text{ V}$ ,  $f_{LO} = 1960\text{ MHz}$  at 8 dBm,  $V_{inBB} = 98\text{ mVrms}$  single-ended in quadrature,  $f_{BB} = 50\text{ kHz}$  (unless otherwise noted)

RF Output Parameters						
	PARAMETER	TEST CONDITIONS	MIN	TYP	MAX	UNIT
G	Voltage gain	Output rms voltage over input I (or Q) rms voltage		-2.5		dB
P1dB	Output compression point			12		dBm
IP3	Output IP3	$f_{BB} = 4.5, 5.5\text{ MHz}$	23.5	26.5		dBm
IP2	Output IP2	$f_{BB} = 4.5, 5.5\text{ MHz}$		60		dBm
	Carrier feedthrough	Unadjusted		-38		dBm
	Sideband suppression	Unadjusted		-50		dBc
	Output return loss			8		dB
	Output noise floor	$\geq 13\text{ MHz}$ offset from $f_{LO}$ ; $P_{out} = -5\text{ dBm}$		-162.5		dBm/Hz
EVM	Error vector magnitude (rms)	1 EDGE signal; $P_{out} = -5\text{ dBm}^{(1)}$		0.43%		
ACPR <sup>(2)</sup>	Adjacent-channel power ratio	1 WCDMA signal; $P_{out} = -8\text{ dBm}$		-74		dBc
		2 WCDMA signals; $P_{out} = -11\text{ dBm}$ per carrier		-68		
		4 WCDMA signals; $P_{out} = -14\text{ dBm}$ per carrier		-67		
	Alternate-channel power ratio	1 WCDMA signal; $P_{out} = -8\text{ dBm}$		-78		dBc
		2 WCDMA signals; $P_{out} = -11\text{ dBm}$ per carrier		-72		
		4 WCDMA signals; $P_{out} = -14\text{ dBm}$ per carrier		-69		

(1) The contribution from the source of about 0.28% is not de-embedded from the measurement.

(2) Measured with DAC5687 as source generator

## ELECTRICAL CHARACTERISTICS

over recommended operating conditions, power supply = 5 V,  $T_A = 25^\circ\text{C}$ ,  $V_{CM} = 1.7\text{ V}$ ,  $f_{LO} = 2140\text{ MHz}$  at 8 dBm,  $V_{inBB} = 98\text{ mVrms}$  single-ended in quadrature,  $f_{BB} = 50\text{ kHz}$  (unless otherwise noted)

RF Output Parameters						
	PARAMETER	TEST CONDITIONS	MIN	TYP	MAX	UNIT
G	Voltage gain	Output rms voltage over input I (or Q) rms voltage		-2.4		dB
P1dB	Output compression point			12		dBm
IP3	Output IP3	$f_{BB} = 4.5, 5.5\text{ MHz}$		26.5		dBm
IP2	Output IP2	$f_{BB} = 4.5, 5.5\text{ MHz}$		66		dBm
	Carrier feedthrough	Unadjusted		-38		dBm
	Sideband suppression	Unadjusted		-50		dBc
	Output return loss			8.5		dB
	Output noise floor	$\geq 13\text{ MHz}$ offset from $f_{LO}$ ; $P_{out} = -5\text{ dBm}$		-162.5		dBm/Hz
ACPR <sup>(1)</sup>	Adjacent-channel power ratio	1 WCDMA signal; $P_{out} = -8\text{ dBm}$		-72		dBc
		2 WCDMA signal; $P_{out} = -11\text{ dBm}$ per carrier		-67		
		4 WCDMA signals; $P_{out} = -14\text{ dBm}$ per carrier		-66		
	Alternate-channel power ratio	1 WCDMA signal; $P_{out} = -8\text{ dBm}$		-78		dBc
		2 WCDMA signal; $P_{out} = -11\text{ dBm}$		-74		
		4 WCDMA signals; $P_{out} = -14\text{ dBm}$ per carrier		-68		

(1) Measured with DAC5687 as source generator

## ELECTRICAL CHARACTERISTICS

over recommended operating conditions, power supply = 5 V,  $T_A = 25^\circ\text{C}$ ,  $V_{CM} = 1.7\text{ V}$ ,  $f_{LO} = 2500\text{ MHz}$  at 8 dBm,  $V_{inBB} = 98\text{ mVrms}$  single-ended in quadrature,  $f_{BB} = 50\text{ kHz}$  (unless otherwise noted)

RF Output Parameters					
PARAMETER	TEST CONDITIONS	MIN	TYP	MAX	UNIT
G	Voltage gain	Output rms voltage over input I (or Q) rms voltage		-1.6	dB
P1dB	Output compression point			13	dBm
IP3	Output IP3	$f_{BB} = 4.5, 5.5\text{ MHz}$		29	dBm
IP2	Output IP2	$f_{BB} = 4.5, 5.5\text{ MHz}$		65	dBm
	Carrier feedthrough	Unadjusted		-37	dBm
	Sideband suppression	Unadjusted		-47	dBc
EVM	Error vector magnitude (rms)	WiMAX 5-MHz carrier, $P_{out} = -8\text{ dBm}$ , LO = 8 dBm		-47	dB
		WiMAX 5-MHz carrier, $P_{out} = 0\text{ dBm}$ , LO = 8 dBm		-45	dB

## ELECTRICAL CHARACTERISTICS

over recommended operating conditions, power supply = 5 V,  $T_A = 25^\circ\text{C}$ ,  $V_{CM} = 1.7\text{ V}$ ,  $f_{LO} = 3500\text{ MHz}$  at 8 dBm,  $V_{inBB} = 98\text{ mVrms}$  single-ended in quadrature,  $f_{BB} = 50\text{ kHz}$  (unless otherwise noted)

RF Output Parameters					
PARAMETER	TEST CONDITIONS	MIN	TYP	MAX	UNIT
G	Voltage gain	Output rms voltage over input I (or Q) rms voltage		0.6	dB
P1dB	Output compression point			13.5	dBm
IP3	Output IP3	$f_{BB} = 4.5, 5.5\text{ MHz}$		25	dBm
IP2	Output IP2	$f_{BB} = 4.5, 5.5\text{ MHz}$		65	dBm
	Carrier feedthrough	Unadjusted		-35	dBm
	Sideband suppression	Unadjusted		-36	dBc
EVM	Error vector magnitude (rms)	WiMAX 5-MHz carrier, $P_{out} = -8\text{ dBm}$ , LO = 6 dBm		-47	dB
		WiMAX 5-MHz carrier, $P_{out} = 0\text{ dBm}$ , LO = 6 dBm		-43	dB

## ELECTRICAL CHARACTERISTICS

over recommended operating conditions, power supply = 5 V,  $T_A = 25^\circ\text{C}$ ,  $V_{CM} = 1.7\text{ V}$ ,  $f_{LO} = 4000\text{ MHz}$  at 8 dBm,  $V_{inBB} = 98\text{ mVrms}$  single-ended in quadrature,  $f_{BB} = 50\text{ kHz}$  (unless otherwise noted)

RF Output Parameters					
PARAMETER	TEST CONDITIONS	MIN	TYP	MAX	UNIT
G	Voltage gain	Output rms voltage over input I (or Q) rms voltage		0.2	dB
P1dB	Output compression point			12	dBm
IP3	Output IP3	$f_{BB} = 4.5, 5.5\text{ MHz}$		22.5	dBm
IP2	Output IP2	$f_{BB} = 4.5, 5.5\text{ MHz}$		60	dBm
	Carrier feedthrough	Unadjusted		-36	dBm
	Sideband suppression	Unadjusted		-36	dBc

### TYPICAL CHARACTERISTICS

$V_{CM} = 1.7\text{ V}$ ,  $V_{inBB} = 98\text{ mVrms}$  single-ended sine wave in quadrature,  $V_{CC} = 5\text{ V}$ , LO power = 8 dBm (single-ended),  $f_{BB} = 50\text{ kHz}$  (unless otherwise noted).

**OUTPUT POWER  
vs  
BASEBAND VOLTAGE**

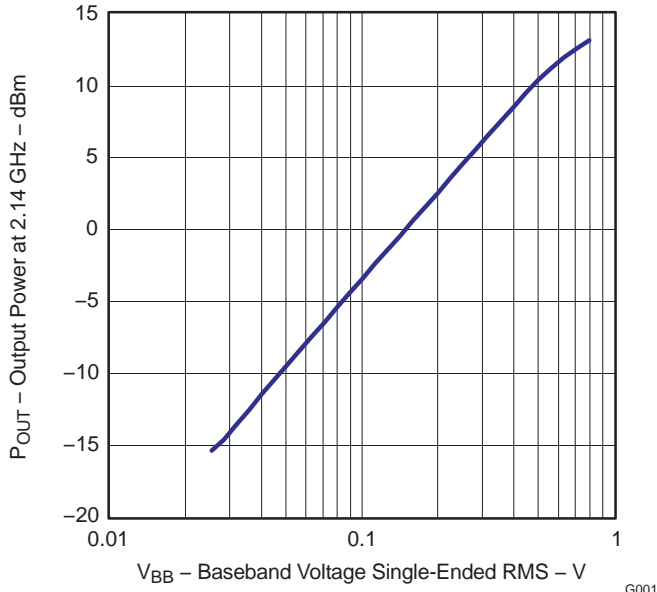

Figure 1.

**OUTPUT POWER  
vs  
FREQUENCY AND TEMPERATURE**

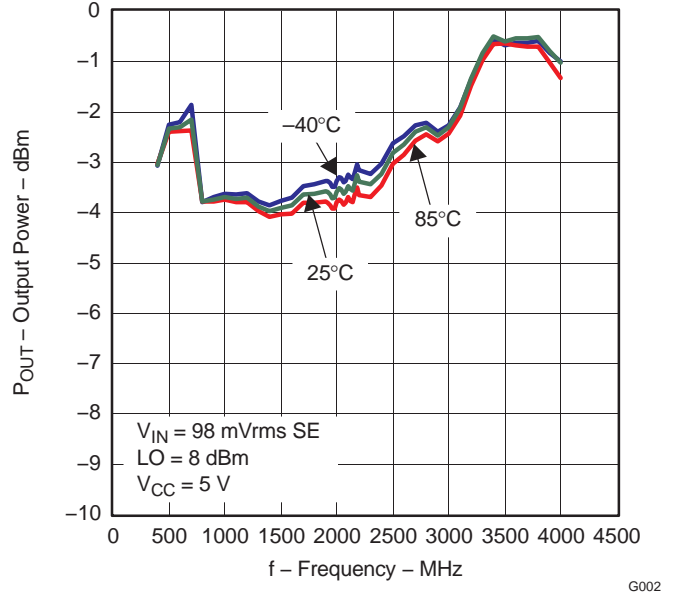

Figure 2.

**OUTPUT POWER  
vs  
FREQUENCY AND SUPPLY VOLTAGE**

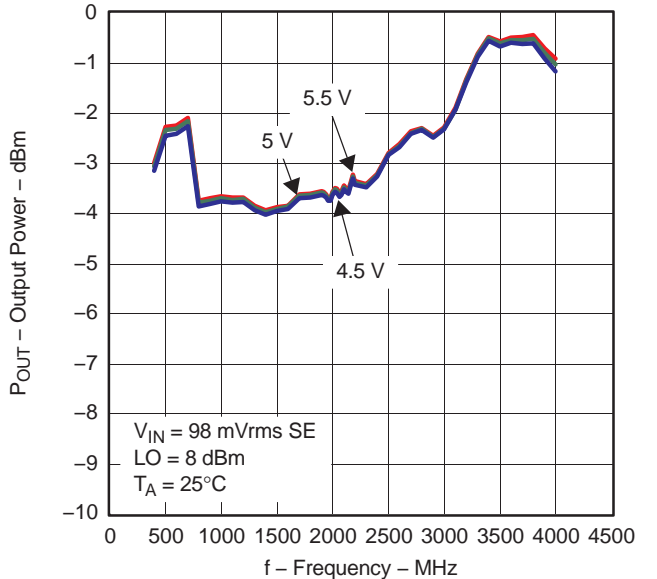

Figure 3.

**OUTPUT POWER  
vs  
FREQUENCY AND LO POWER**

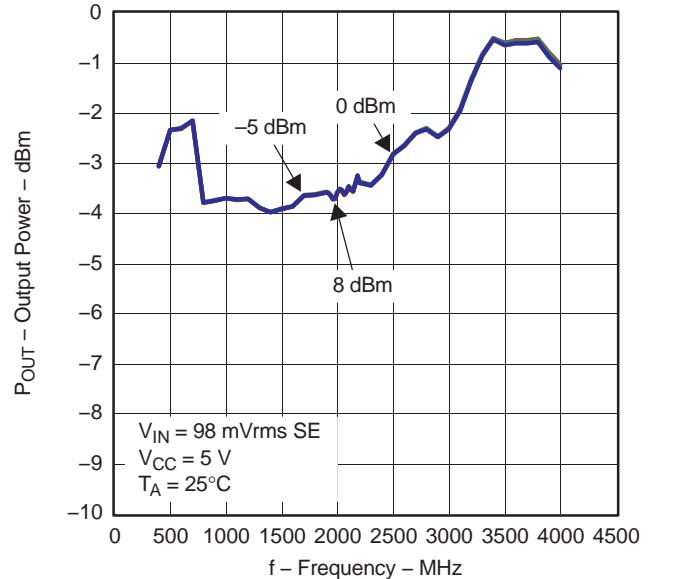

Figure 4.



TYPICAL CHARACTERISTICS (continued)

$V_{CM} = 1.7\text{ V}$ ,  $V_{inBB} = 98\text{ mVrms}$  single-ended sine wave in quadrature,  $V_{CC} = 5\text{ V}$ , LO power = 8 dBm (single-ended),  $f_{BB} = 50\text{ kHz}$  (unless otherwise noted).

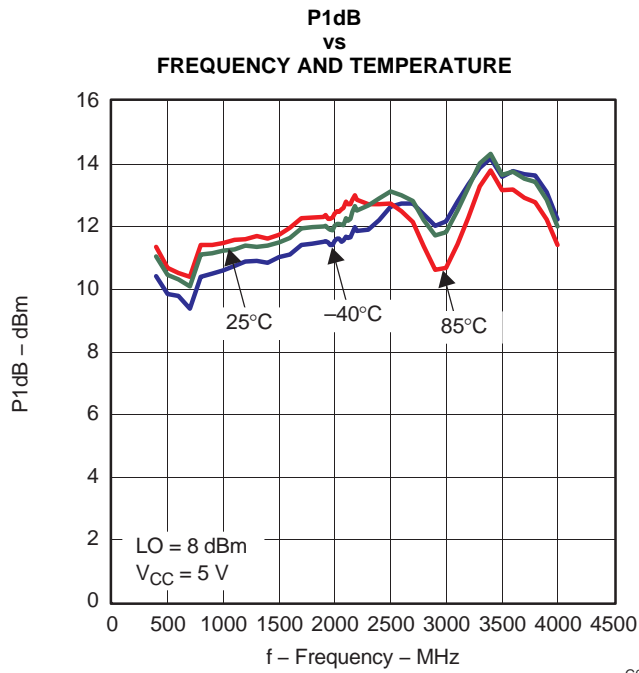

Figure 5.

G005

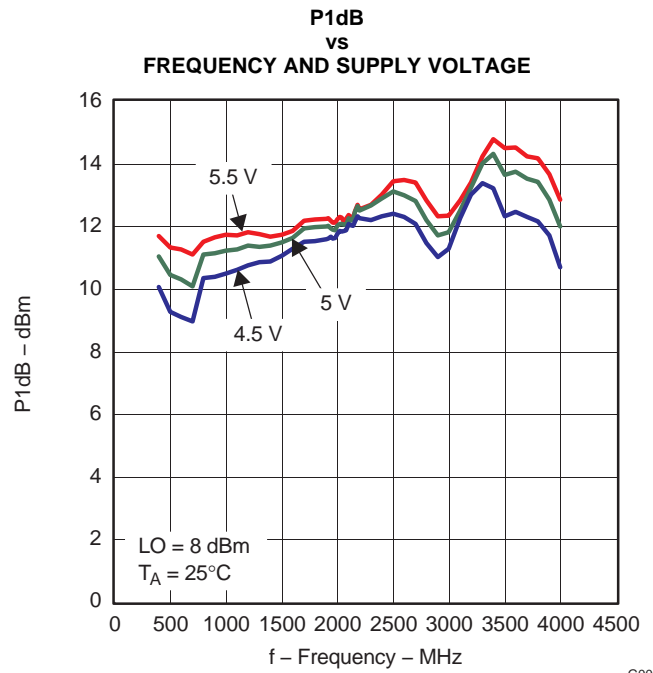

Figure 6.

G006

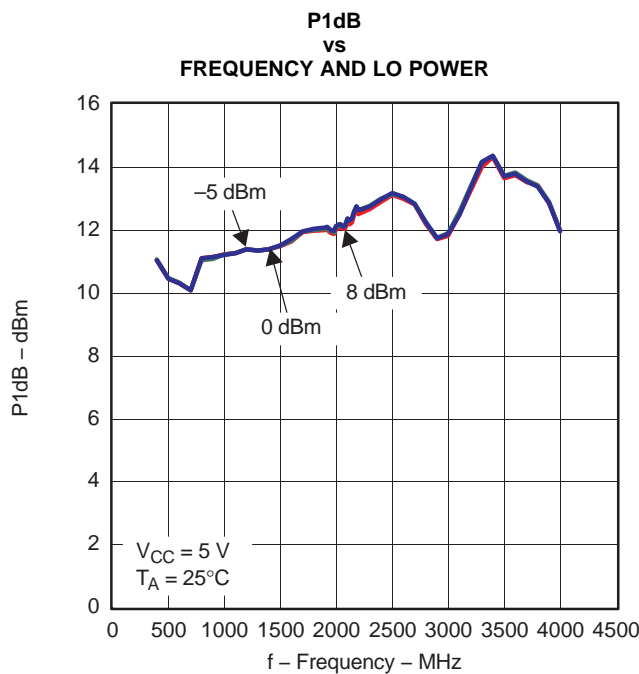

Figure 7.

G007

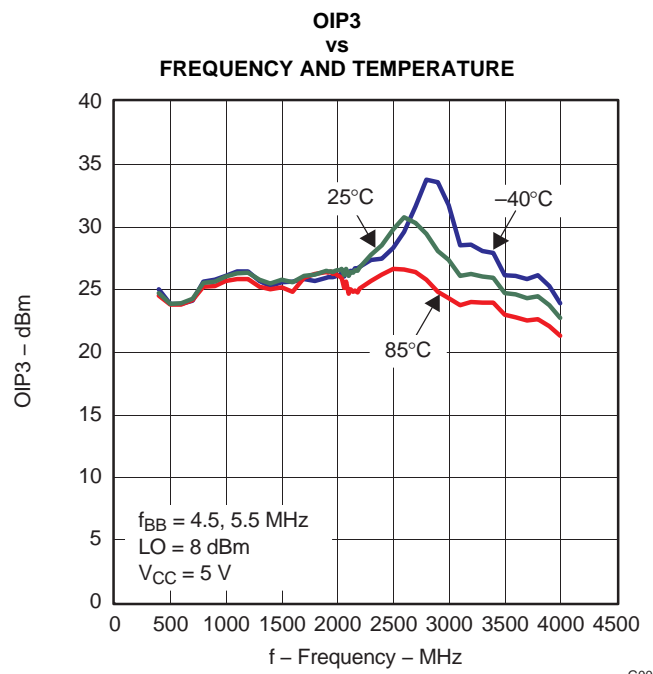

Figure 8.

G008

**TYPICAL CHARACTERISTICS (continued)**

$V_{CM} = 1.7\text{ V}$ ,  $V_{inBB} = 98\text{ mVrms}$  single-ended sine wave in quadrature,  $V_{CC} = 5\text{ V}$ , LO power = 8 dBm (single-ended),  $f_{BB} = 50\text{ kHz}$  (unless otherwise noted).

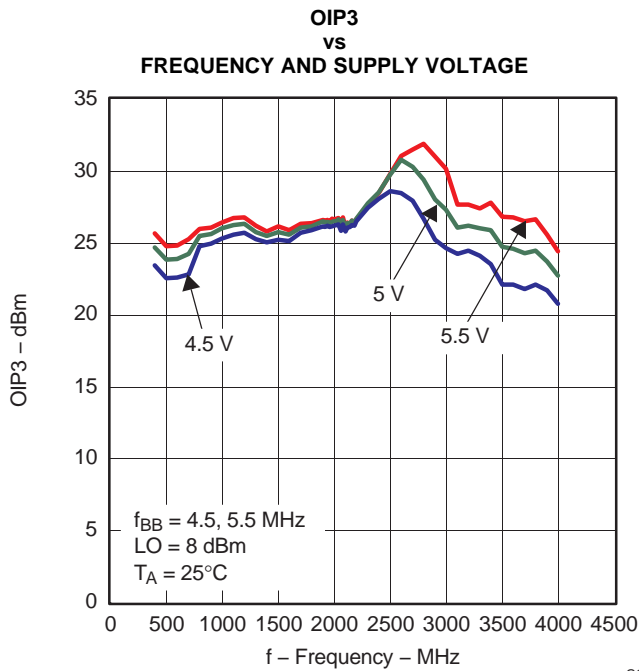

Figure 9.

G009

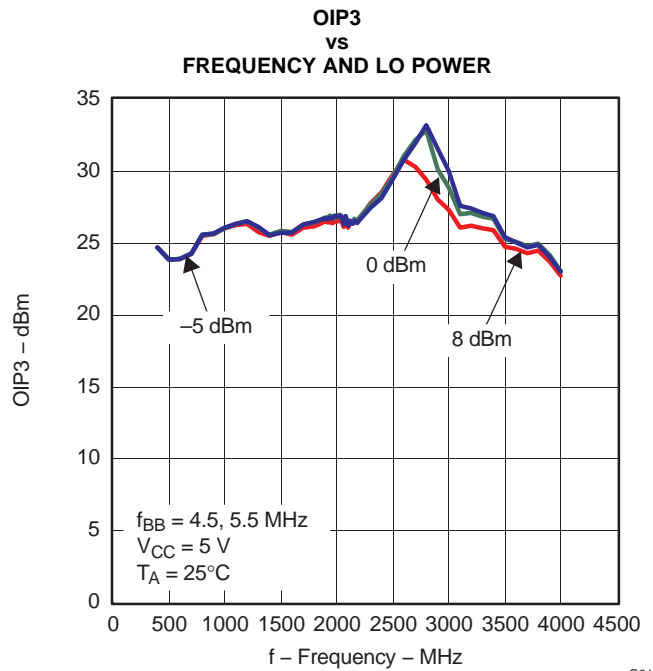

Figure 10.

G010

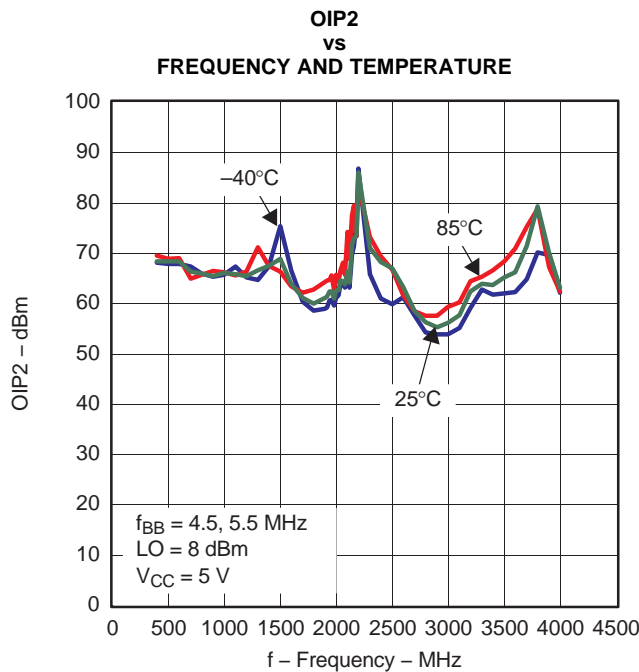

Figure 11.

G011

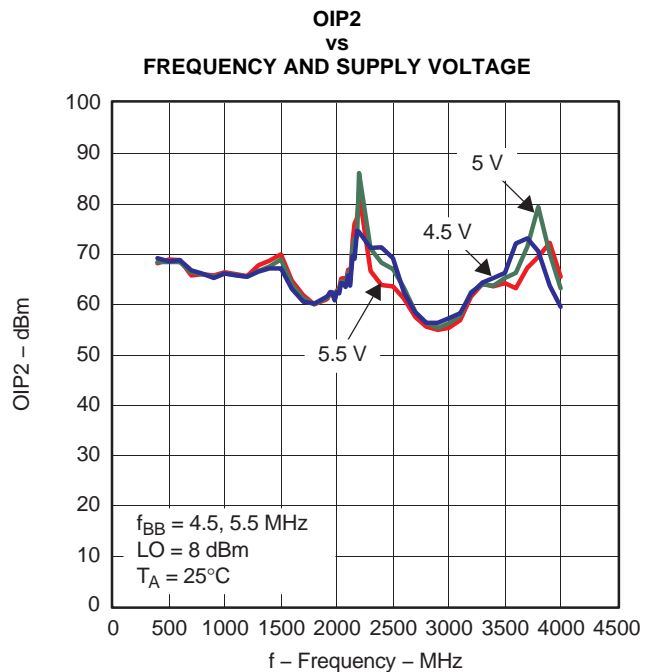

Figure 12.

G012

TYPICAL CHARACTERISTICS (continued)

$V_{CM} = 1.7\text{ V}$ ,  $V_{inBB} = 98\text{ mVrms}$  single-ended sine wave in quadrature,  $V_{CC} = 5\text{ V}$ , LO power = 8 dBm (single-ended),  $f_{BB} = 50\text{ kHz}$  (unless otherwise noted).

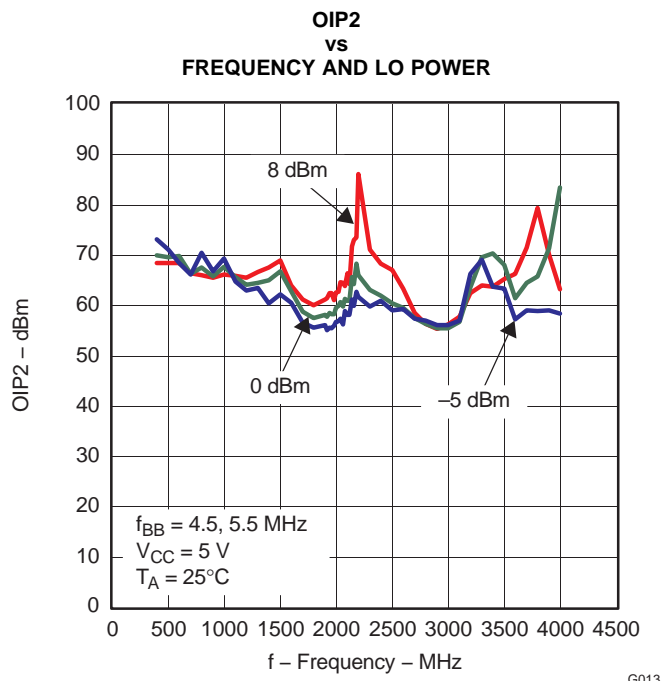

Figure 13.

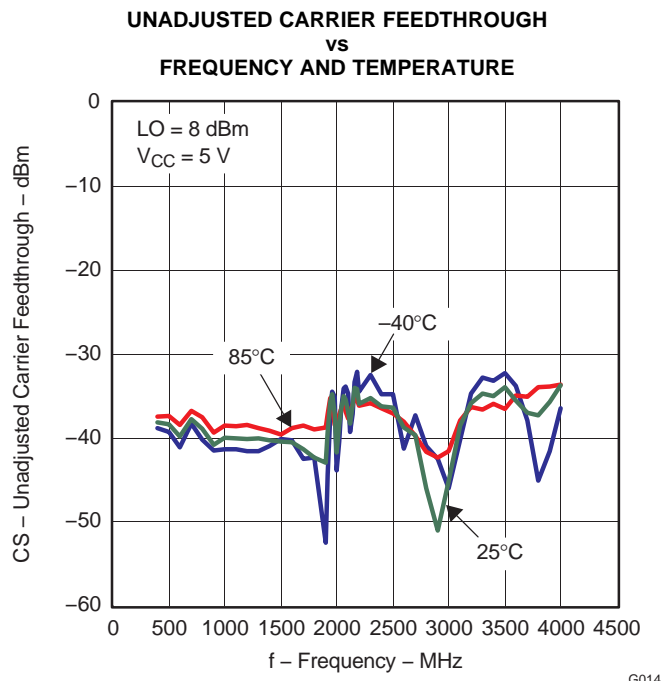

Figure 14.

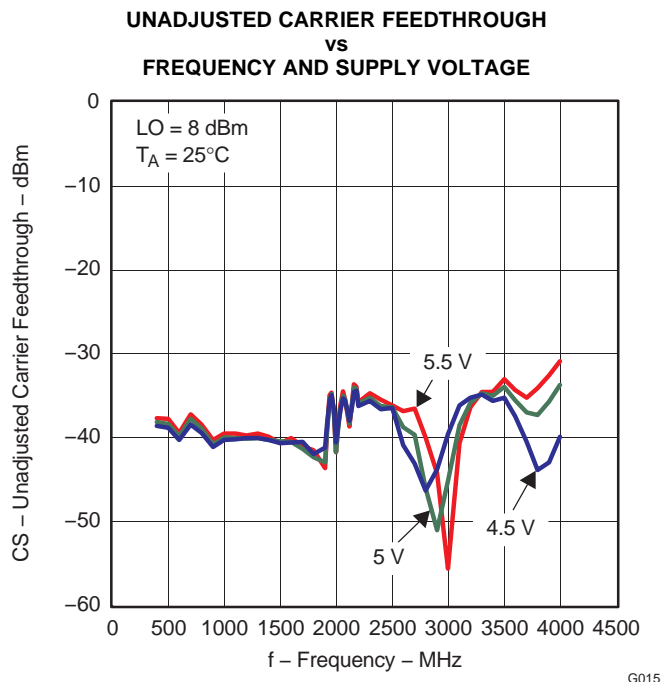

Figure 15.

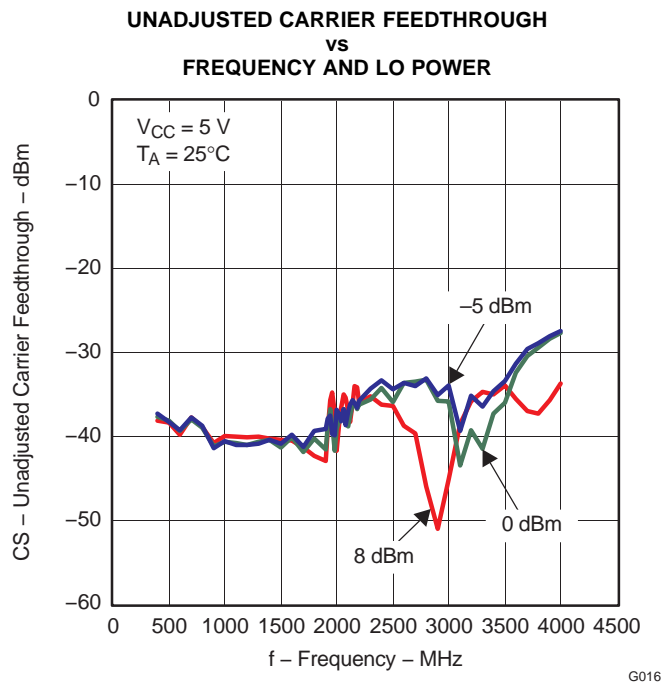
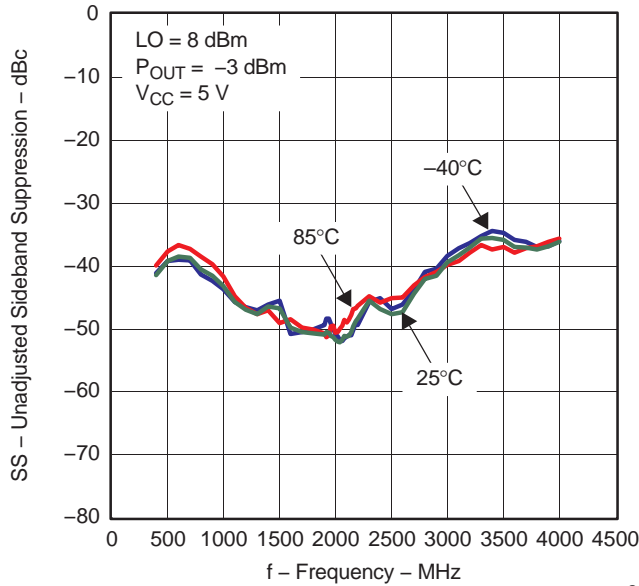

Figure 16.

**TYPICAL CHARACTERISTICS (continued)**

$V_{CM} = 1.7\text{ V}$ ,  $V_{inBB} = 98\text{ mVrms}$  single-ended sine wave in quadrature,  $V_{CC} = 5\text{ V}$ , LO power = 8 dBm (single-ended),  $f_{BB} = 50\text{ kHz}$  (unless otherwise noted).

**UNADJUSTED SIDEBAND SUPPRESSION  
vs  
FREQUENCY AND TEMPERATURE**



**Figure 17.**

**UNADJUSTED SIDEBAND SUPPRESSION  
vs  
FREQUENCY AND SUPPLY VOLTAGE**

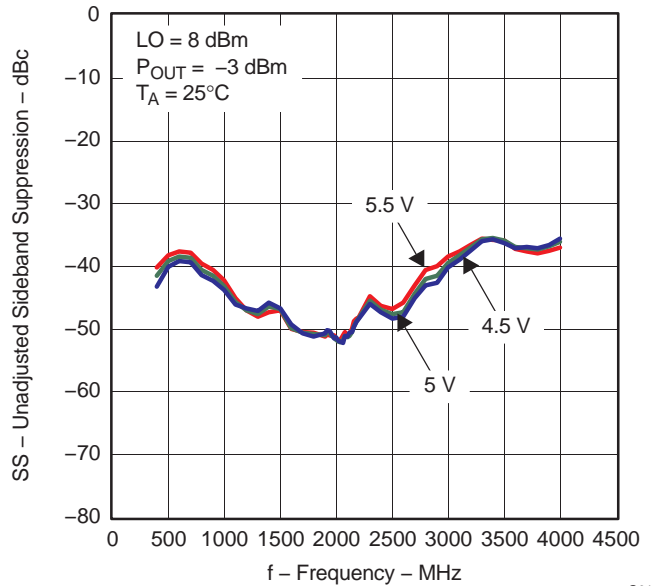

**Figure 18.**

**UNADJUSTED SIDEBAND SUPPRESSION  
vs  
FREQUENCY AND LO POWER**

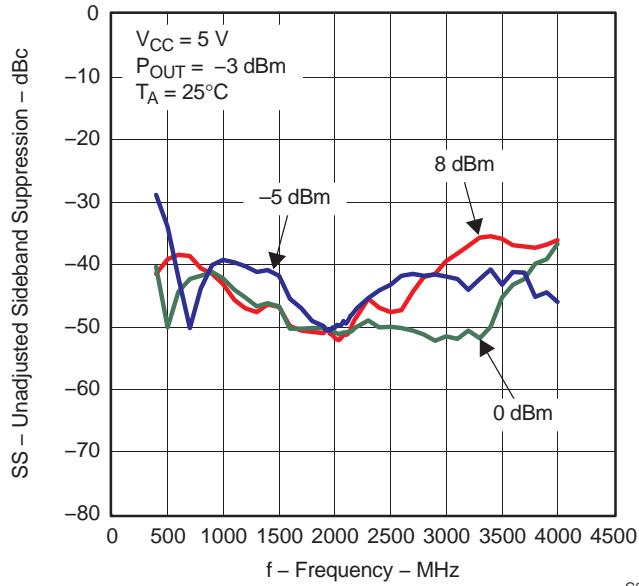

**Figure 19.**

**NOISE AT 13-MHz OFFSET (dBm/Hz)  
vs  
FREQUENCY AND TEMPERATURE**

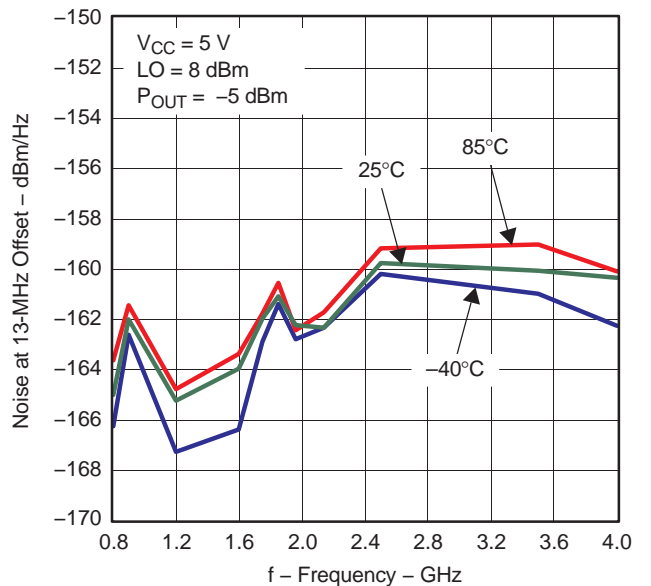
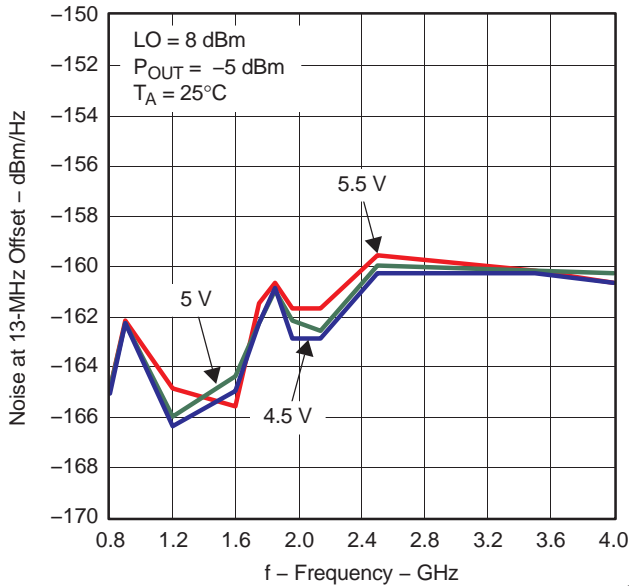

**Figure 20.**

**TYPICAL CHARACTERISTICS (continued)**

$V_{CM} = 1.7\text{ V}$ ,  $V_{inBB} = 98\text{ mVrms}$  single-ended sine wave in quadrature,  $V_{CC} = 5\text{ V}$ , LO power = 8 dBm (single-ended),  $f_{BB} = 50\text{ kHz}$  (unless otherwise noted).

**NOISE AT 13-MHz OFFSET (dBm/Hz)  
vs  
FREQUENCY AND SUPPLY VOLTAGE**



**Figure 21.**

**NOISE AT 13-MHz OFFSET (dBm/Hz)  
vs  
OUTPUT POWER**

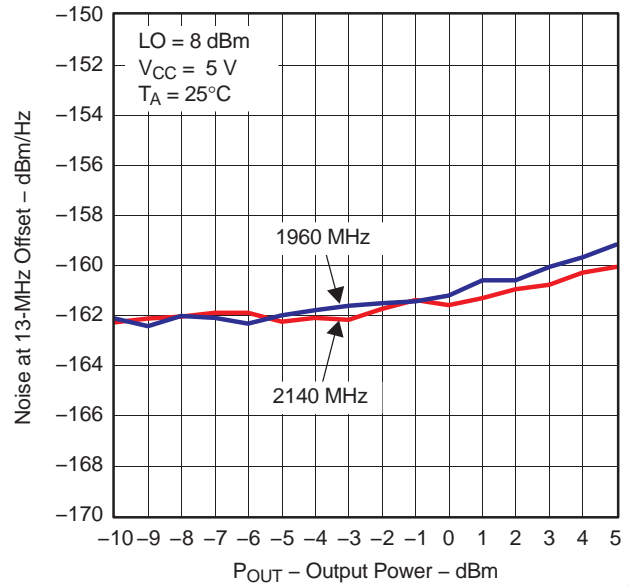

**Figure 22.**

**ADJUSTED CARRIER FEEDTHROUGH  
vs  
FREQUENCY AND TEMPERATURE**

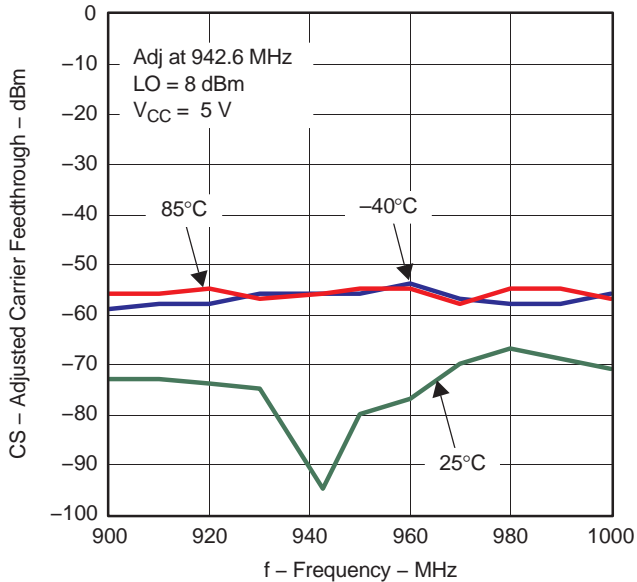

**Figure 23.**

**ADJUSTED CARRIER FEEDTHROUGH  
vs  
FREQUENCY AND TEMPERATURE**

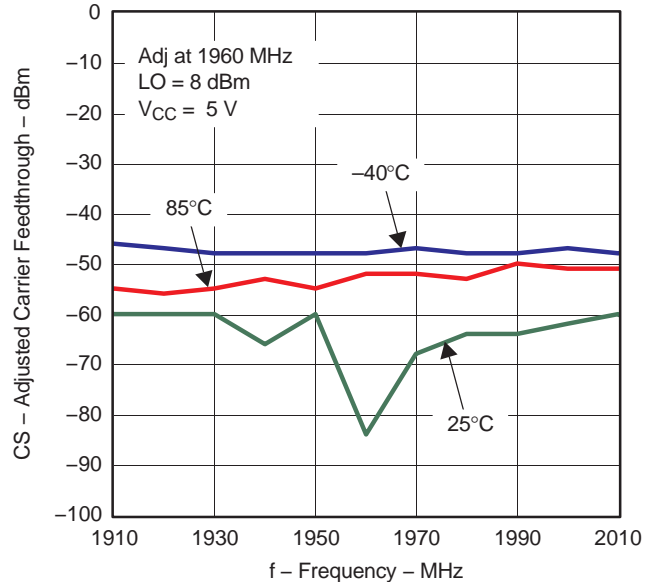
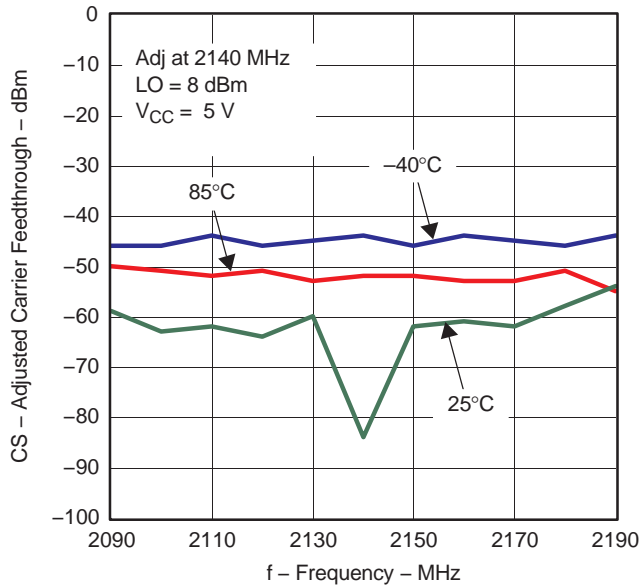

**Figure 24.**

**TYPICAL CHARACTERISTICS (continued)**

$V_{CM} = 1.7\text{ V}$ ,  $V_{inBB} = 98\text{ mVrms}$  single-ended sine wave in quadrature,  $V_{CC} = 5\text{ V}$ , LO power = 8 dBm (single-ended),  $f_{BB} = 50\text{ kHz}$  (unless otherwise noted).

**ADJUSTED CARRIER FEEDTHROUGH  
vs  
FREQUENCY AND TEMPERATURE**



**Figure 25.**

**ADJUSTED CARRIER FEEDTHROUGH  
vs  
FREQUENCY AND TEMPERATURE**

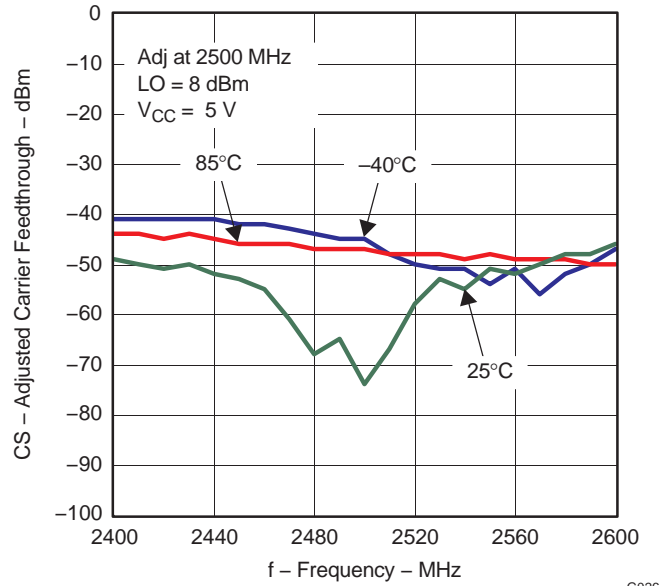

**Figure 26.**

**ADJUSTED CARRIER FEEDTHROUGH  
vs  
FREQUENCY AND TEMPERATURE**

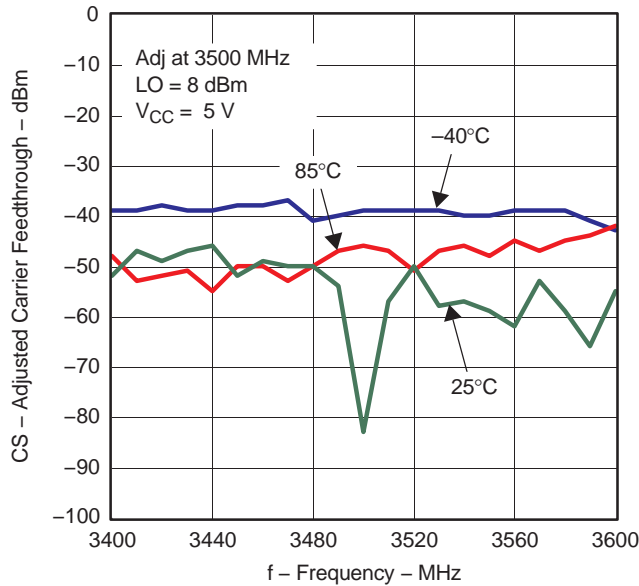

**Figure 27.**

**ADJUSTED SIDEBAND SUPPRESSION  
vs  
FREQUENCY AND TEMPERATURE**

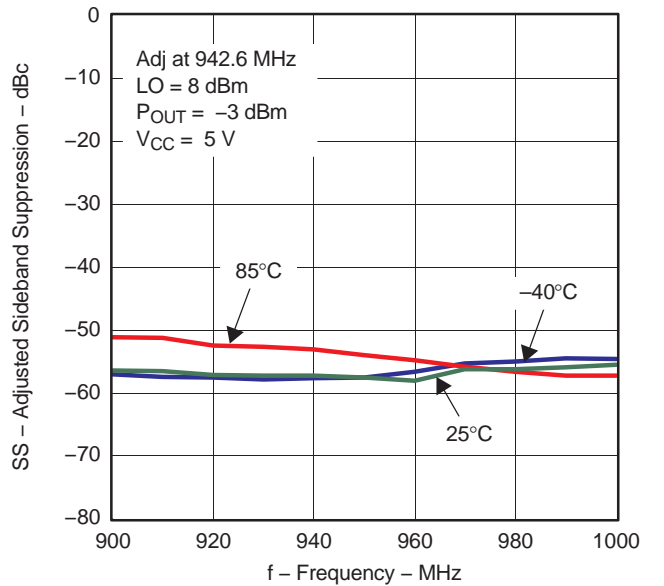

**Figure 28.**

**TYPICAL CHARACTERISTICS (continued)**

$V_{CM} = 1.7\text{ V}$ ,  $V_{inBB} = 98\text{ mVrms}$  single-ended sine wave in quadrature,  $V_{CC} = 5\text{ V}$ , LO power = 8 dBm (single-ended),  $f_{BB} = 50\text{ kHz}$  (unless otherwise noted).

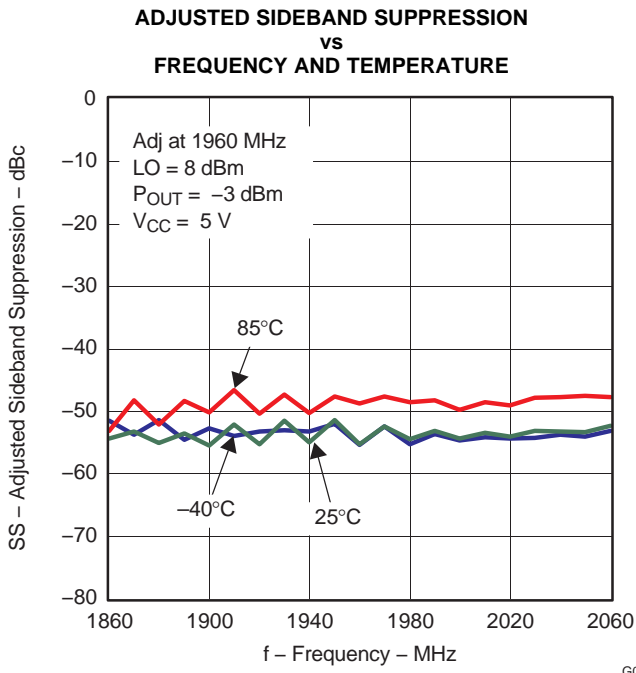

Figure 29.

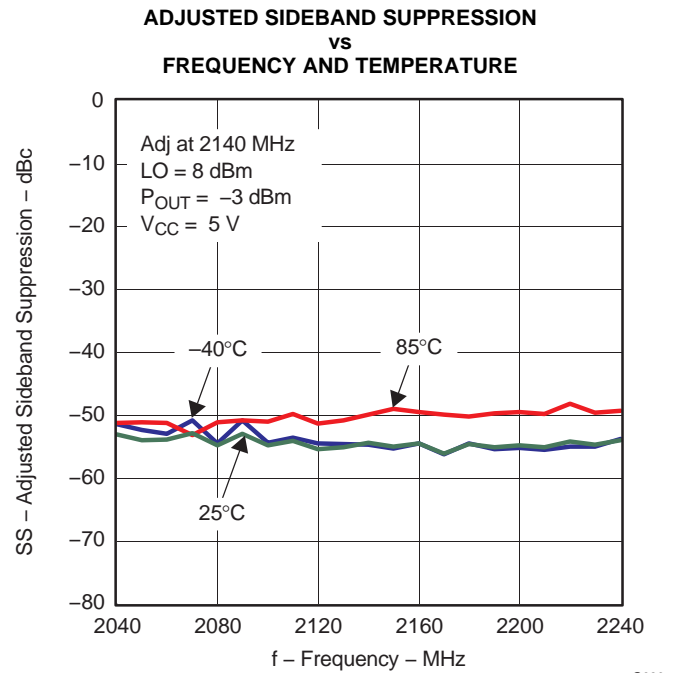

Figure 30.

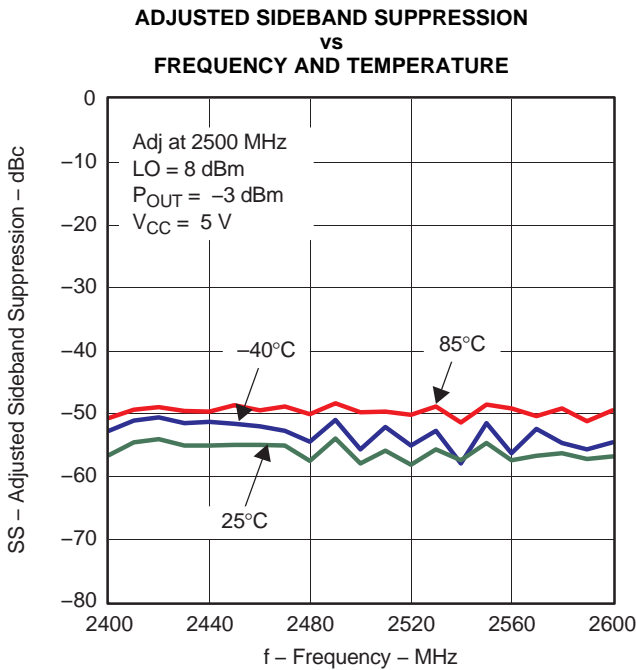

Figure 31.

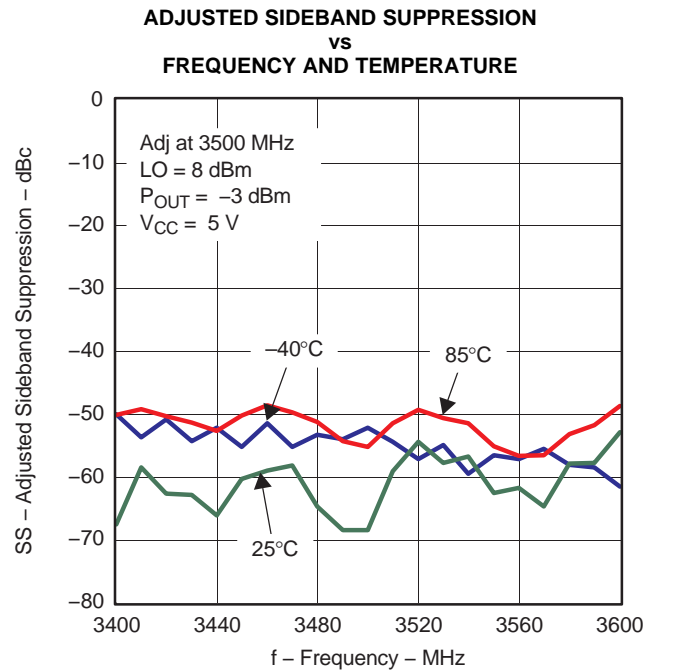

Figure 32.

**TYPICAL CHARACTERISTICS (continued)**

$V_{CM} = 1.7\text{ V}$ ,  $V_{inBB} = 98\text{ mVrms}$  single-ended sine wave in quadrature,  $V_{CC} = 5\text{ V}$ , LO power = 8 dBm (single-ended),  $f_{BB} = 50\text{ kHz}$  (unless otherwise noted).

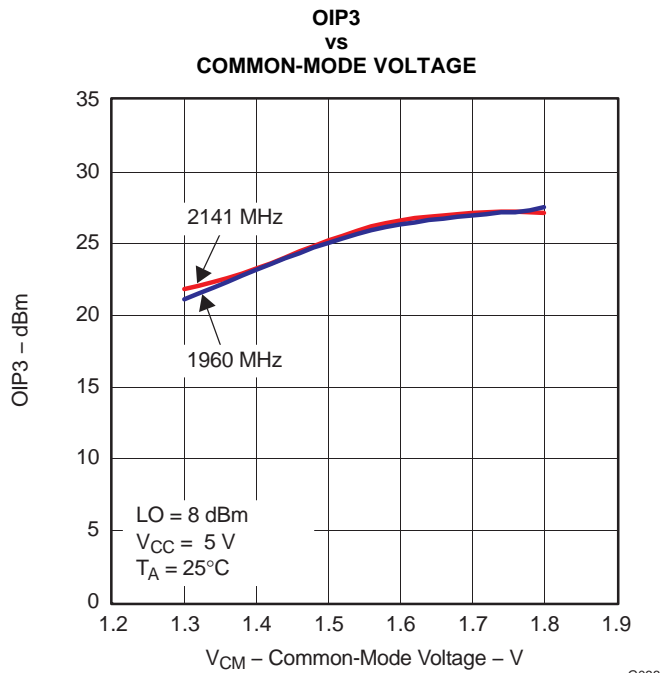

Figure 33.

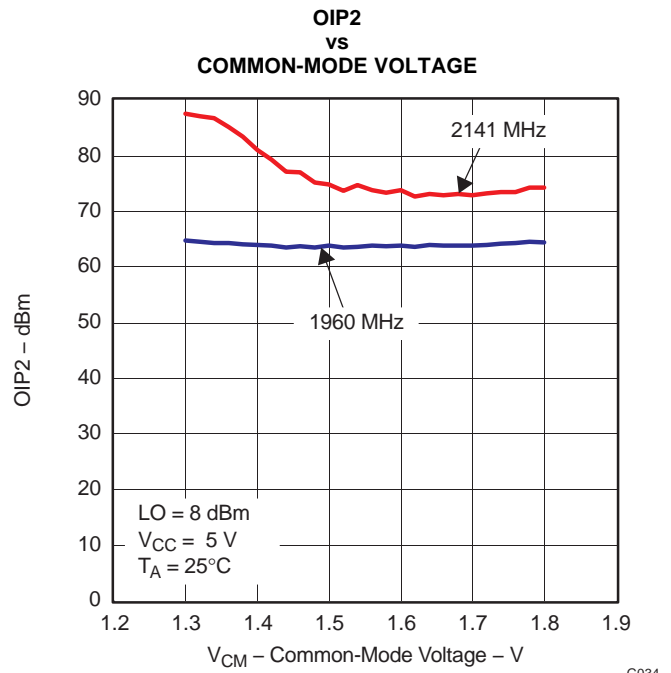

Figure 34.

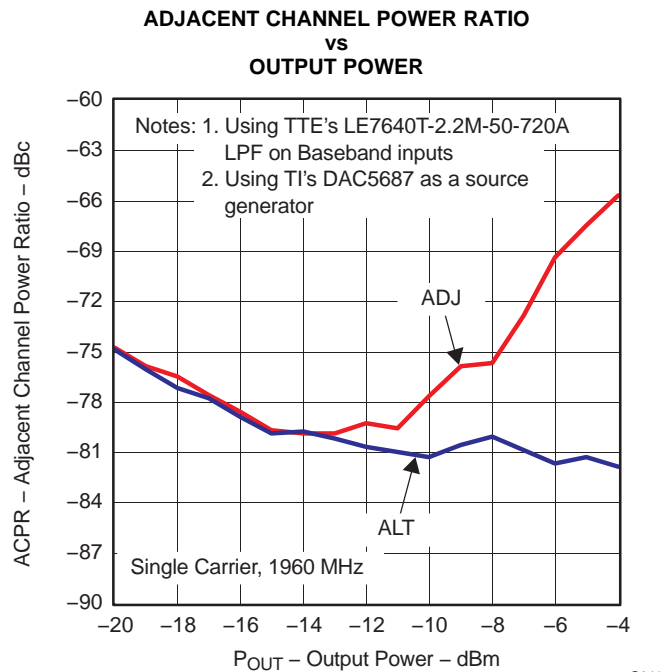

Figure 35.

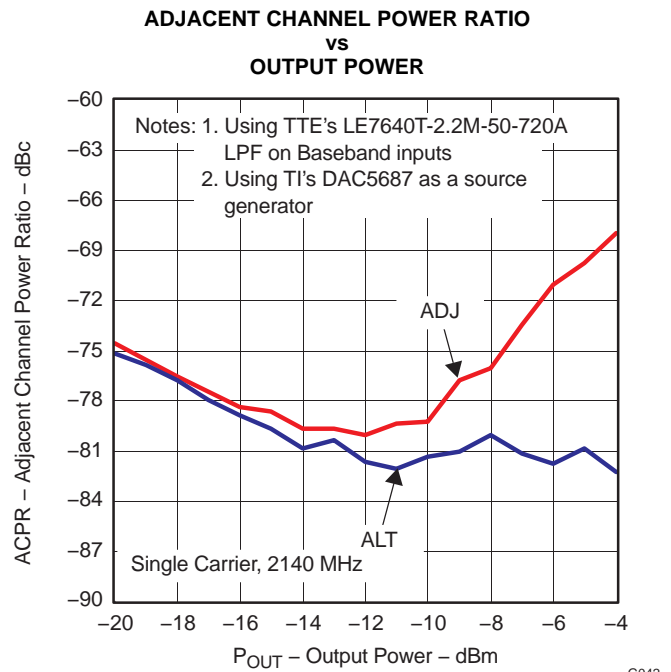

Figure 36.



**TYPICAL CHARACTERISTICS (continued)**

$V_{CM} = 1.7\text{ V}$ ,  $V_{inBB} = 98\text{ mVrms}$  single-ended sine wave in quadrature,  $V_{CC} = 5\text{ V}$ , LO power = 8 dBm (single-ended),  $f_{BB} = 50\text{ kHz}$  (unless otherwise noted).

**OIP3 at 1960 MHz DISTRIBUTION**

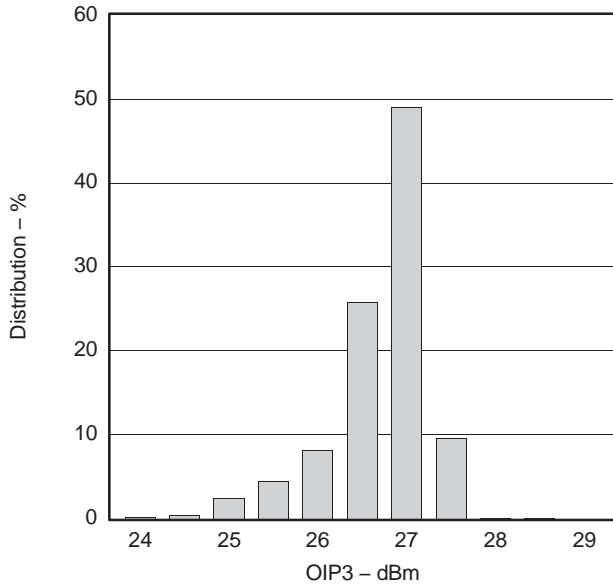

**Figure 37.**

G036

**OIP2 at 1960 MHz DISTRIBUTION**

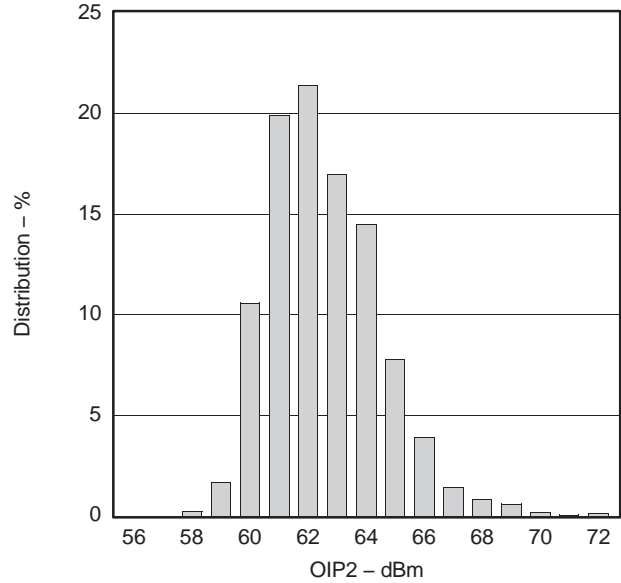

**Figure 38.**

G037

**UNADJUSTED CARRIER FEEDTHROUGH at 1960 MHz DISTRIBUTION**

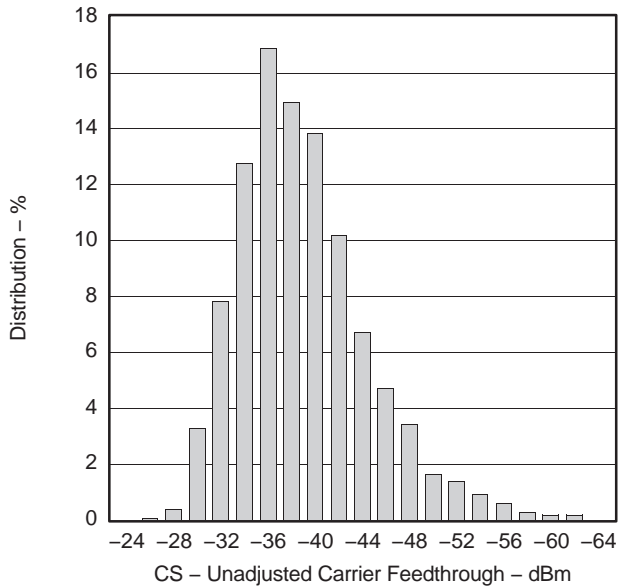

**Figure 39.**

G038

**UNADJUSTED SIDEBAND SUPPRESSION at 1960 MHz DISTRIBUTION**

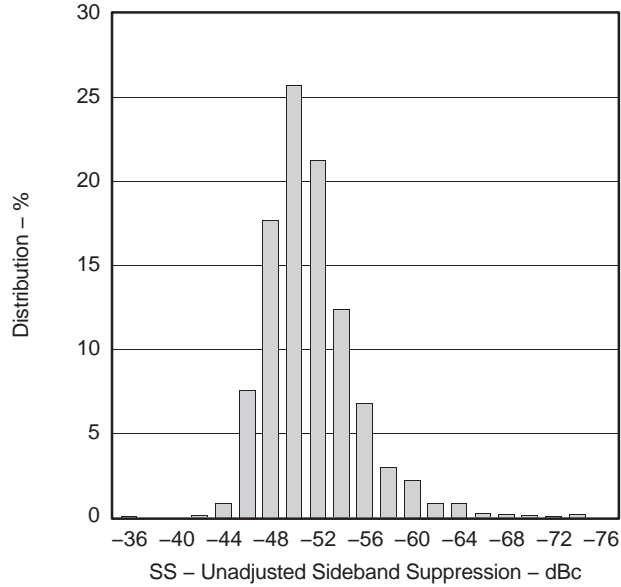

**Figure 40.**

G039

### TYPICAL CHARACTERISTICS (continued)

$V_{CM} = 1.7\text{ V}$ ,  $V_{inBB} = 98\text{ mVrms}$  single-ended sine wave in quadrature,  $V_{CC} = 5\text{ V}$ , LO power = 8 dBm (single-ended),  $f_{BB} = 50\text{ kHz}$  (unless otherwise noted).

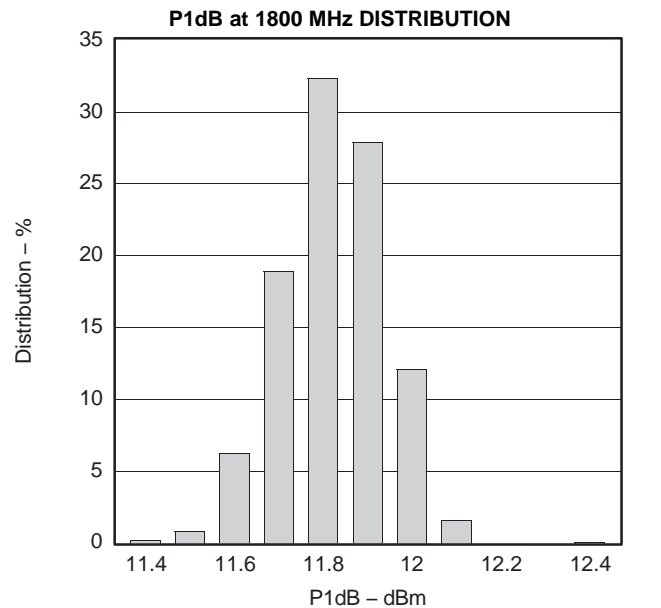

Figure 41.

## APPLICATION INFORMATION AND EVALUATION BOARD

### Basic Connections

- See [Figure 42](#) for proper connection of the TRF3703 modulator.
- Connect a single power supply (4.5 V–5.5 V) to pins 18 and 24. These pins should be decoupled as shown on pins 4, 5, 6, and 7.
- Connect pins 2, 5, 8, 11, 12, 14, 17, 19, 20, and 23 to GND.
- Connect a single-ended LO source of desired frequency to LOP (amplitude between –5 dBm and 12 dBm). This should be ac-coupled through a 100-pF capacitor.
- Terminate the ac-coupled LON with 50  $\Omega$  to GND.
- Connect a baseband signal to pins 21 = I, 22 =  $\bar{I}$ , 10 = Q, and 9 =  $\bar{Q}$ .
- The differential baseband inputs should be set to the proper common-mode voltage of 1.7V.
- RF\_OUT, pin 16, can be fed to a spectrum analyzer set to the desired frequency, LO  $\pm$  baseband signal. This pin should also be ac-coupled through a 100-pF capacitor.
- All NC pins can be left floating.

### ESD Sensitivity

RF devices may be extremely sensitive to electrostatic discharge (ESD). To prevent damage from ESD, devices should be stored and handled in a way that prevents the build-up of electrostatic voltages that exceed the rated level. Rated ESD levels should also not be exceeded while the device is installed on a printed circuit board (PCB). Follow these guidelines for optimal ESD protection:

- Low ESD performance is not uncommon in RF ICs; see the [Absolute Maximum Ratings](#) table. Therefore, customers' ESD precautions should be consistent with these ratings.
- The device should be robust once assembled onto the PCB **unless** external inputs (connectors, etc.) directly connect the device pins to off-board circuits.

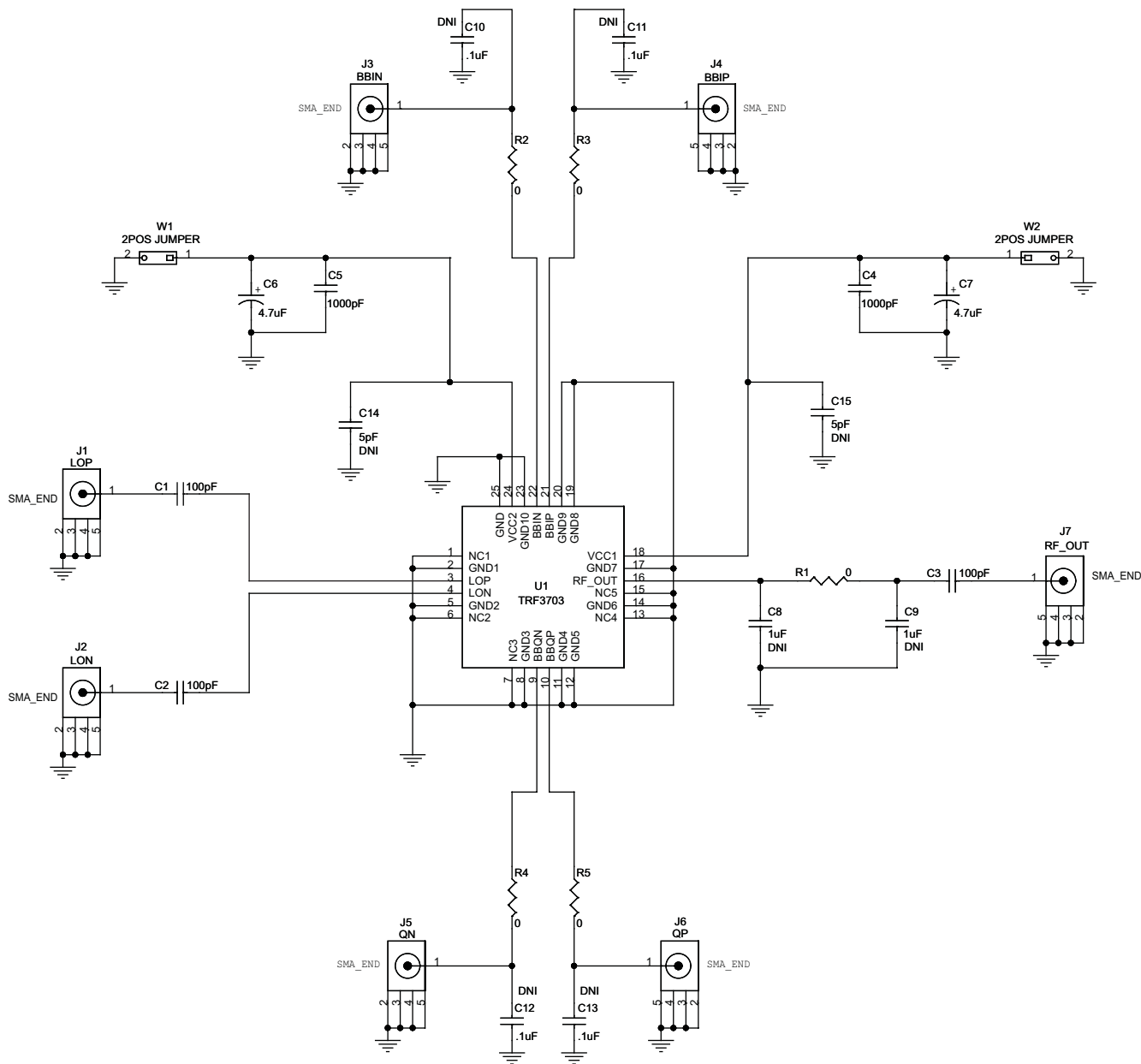

S0214-02

NOTE: DNI = Do not install.

Figure 42. TRF3703 EVM Schematic

Figure 43 shows the top view of the TRF3703 EVM board.

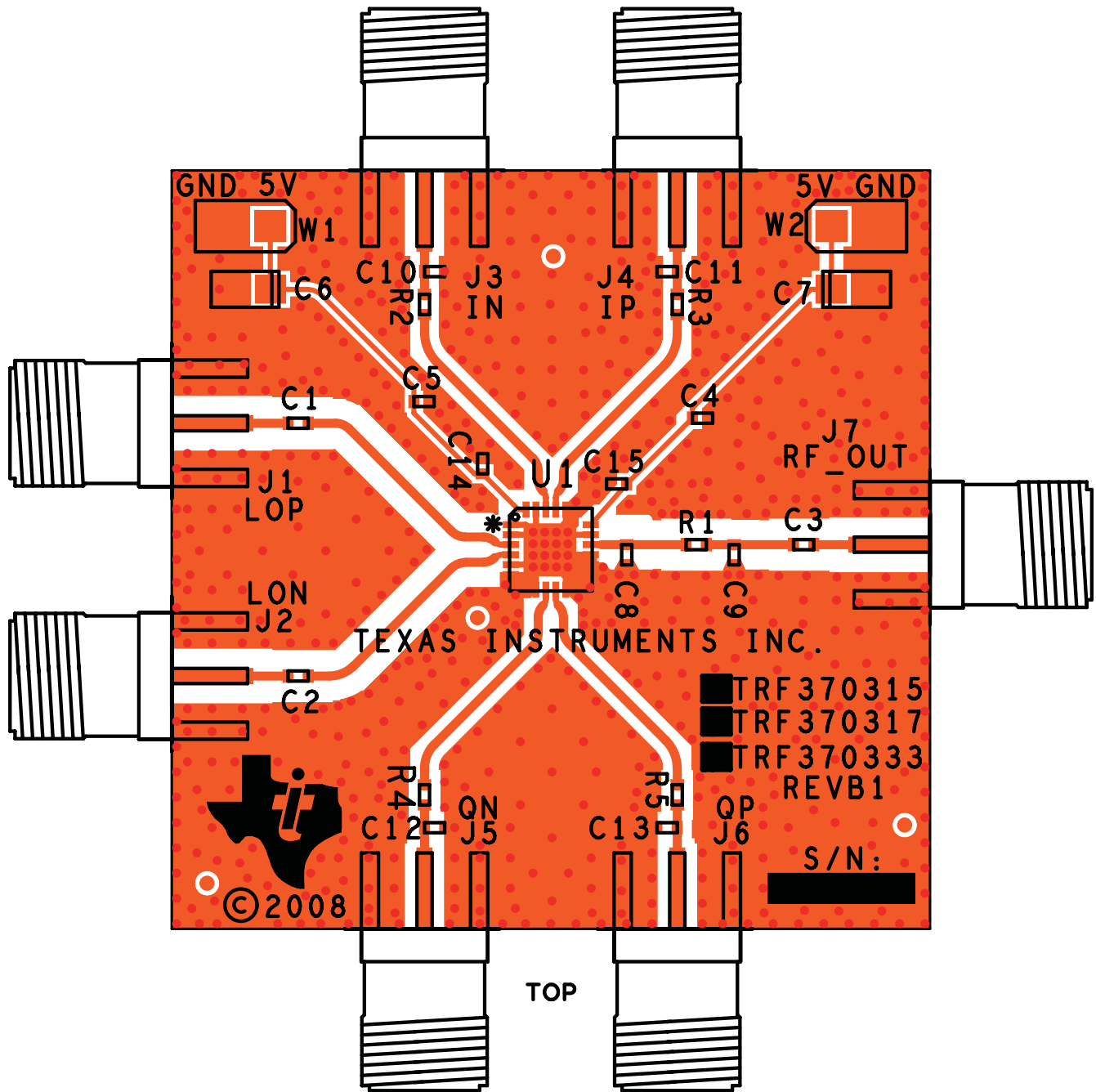

Figure 43. TRF3703 EVM Board Layout

K001

Table 1. Bill of Materials for TRF3703 EVM

Item Number	Quantity	Part Reference	Value	PCB Footprint	Mfr Name	Mfr Part Number	Note
1	3	C1, C2, C3	100 pF	0402	Panasonic	ECJ-0EC1H101J	
2	2	C4, C5	1000 pF	0402	Panasonic	ECJ-0VC1H102J	
3	2	C6, C7	4.7 $\mu$ F	TANT_A	KEMET	T491A475K016AS	
4	0	C8, C9	1 $\mu$ F	0402	Panasonic	ECJ-0EC1H010C_DNI	DNI <sup>(1)</sup>
5	0	C10, C11, C12, C13	0.1 $\mu$ F	0402	Panasonic	ECJ-0EB1A104K_DNI	DNI <sup>(1)</sup>
6	0	C14, C15	5 pF	0402	Panasonic	ECJ-0EC1H050C_DNI	DNI <sup>(1)</sup>
7	7	J1, J2, J3, J4, J5, J6, J7	LOP	SMA_SMEL_250x215	Johnson Components	142-0711-821	
8	1	R1	0	0402	Panasonic	ERJ-2GE0R00X	
9	4	R2, R3, R4, R5	0	0402	Panasonic	ERJ-2GE0R00	
10	1	U1	TRF3703	QFN_24_163x163_0p50mm	TI	TRF370317	
11	2	W1, W2	Jumper_1x2_t hvt	HDR_THVT_1x2_100	Samtec	HTSW-150-07-L-S	

(1) DNI = Do not install.

### GSM Applications

The TRF370317 is suited for GSM and multicarrier GSM applications because of its high linearity and low noise level over the entire recommended operating range. It also has excellent EVM performance, which makes it ideal for the stringent GSM/EDGE applications.

### WCDMA Applications

The TRF370317 is also optimized for WCDMA applications where both adjacent-channel power ratio (ACPR) and noise density are critically important. Using Texas instruments' DAC568X series of high-performance digital-to-analog converters as depicted in Figure 44, excellent ACPR levels were measured with one-, two-, and four-WCDMA carriers. See *Electrical Characteristics*,  $f_{LO} = 1960$  MHz and  $f_{LO} = 2140$  MHz for exact ACPR values.

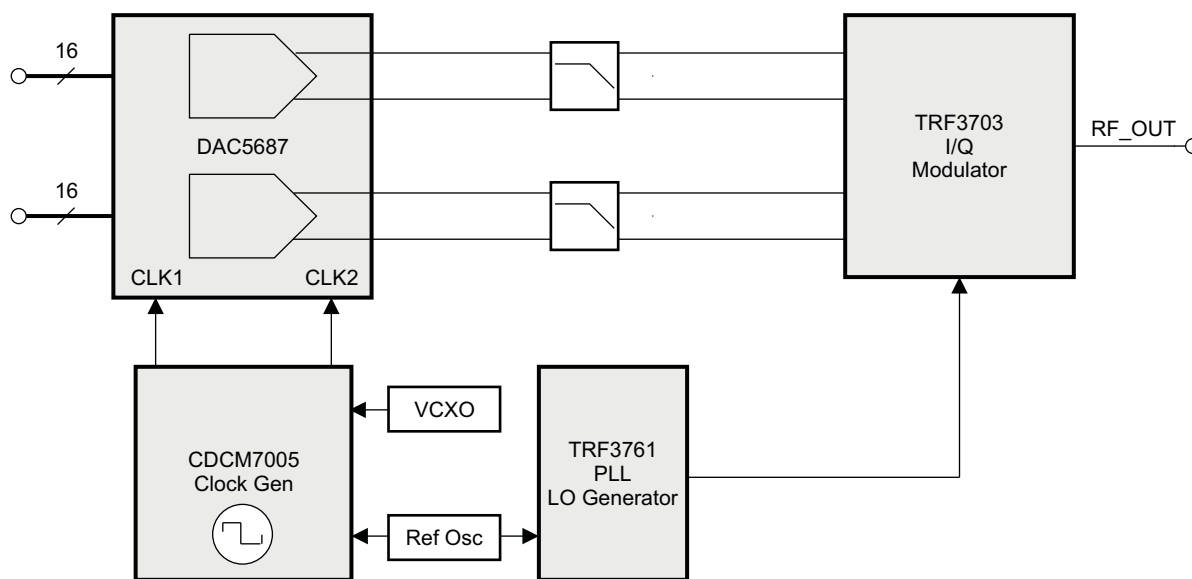

B0176-01

Figure 44. Typical Transmit Setup Block Diagram

## DAC-to-Modulator Interface Network

For optimum linearity and dynamic range, the digital-to-analog converter (DAC) can interface directly with the modulator; however, the common-mode voltage of each device must be maintained. A passive interface circuit is used to transform the common-mode voltage of the DAC to the desired set-point of the modulator. The passive circuit invariably introduces some insertion loss between the two devices. In general, it is desirable to keep the insertion loss as low as possible to achieve the best dynamic range. Figure 45 shows the passive interconnect circuit for two different topologies. One topology is used when the DAC (e.g., DAC568x) common mode is larger than the modulator. The voltage  $V_{ee}$  is nominally set to ground, but can be set to a negative voltage to reduce the insertion loss of the network. The second topology is used when the DAC (e.g., DAC56x2) common mode is smaller than the modulator. Note that this passive interconnect circuit is duplicated for each of the differential I/Q branches.

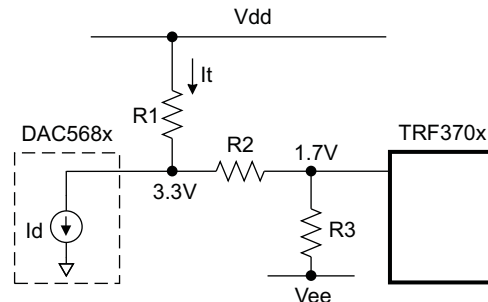

Topology 1: DAC  $V_{cm} >$  TRF370x  $V_{cm}$

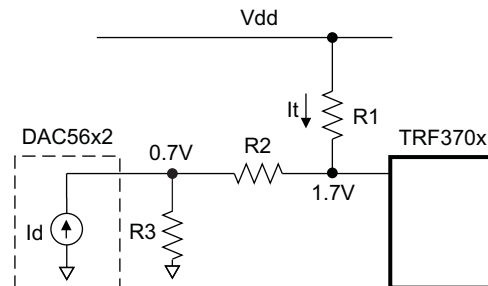

Topology 2: DAC  $V_{cm} <$  TRF370x  $V_{cm}$

S0338-01

**Figure 45. Passive DAC-to-Modulator Interface Network**

**Table 2. DAC-to-Modulator Interface Network Values**

	Topology 1		Topology 2
	With $V_{ee} = 0\text{ V}$	With $V_{ee} = -5\text{ V}$	
DAC $V_{cm}$ [V]	3.3	3.3	0.7
TRF370x $V_{cm}$ [V]	1.7	1.7	1.7
Vdd [V]	5	5	5
Vee [V]	Gnd	-5	N/A
R1 [ $\Omega$ ]	66	56	960
R2 [ $\Omega$ ]	100	80	290
R3 [ $\Omega$ ]	108	336	52
Insertion loss [dB]	5.8	1.9	2.3

## DEFINITION OF SPECIFICATIONS

### Unadjusted Carrier Feedthrough

This specification measures the amount by which the local oscillator component is suppressed in the output spectrum of the modulator. If the common mode voltage at each of the baseband inputs is exactly the same and there was no dc imbalance introduced by the modulator, the LO component would be naturally suppressed. DC offset imbalances in the device allow some of the LO component to feed through to the output. Because this phenomenon is independent of the RF output power and the injected LO input power, the parameter is expressed in absolute power, dBm.

Some improvement to the unadjusted carrier suppression in a localized band is possible by introducing a simple RF filter in the baseband I/Q paths. The filter topology is a series resistor followed by a shunt capacitor. For example, using a series 50- $\Omega$  resistor ( $R_2, R_3, R_4, R_5 = 50 \Omega$ ) followed by a shunt 4.7-pF capacitor ( $C10, C11, C12, C13 = 4.7 \text{ pF}$ ) yields unadjusted carrier suppression improvement around the 2-GHz band. Figure 46 shows the performance improvement for that filter configuration.

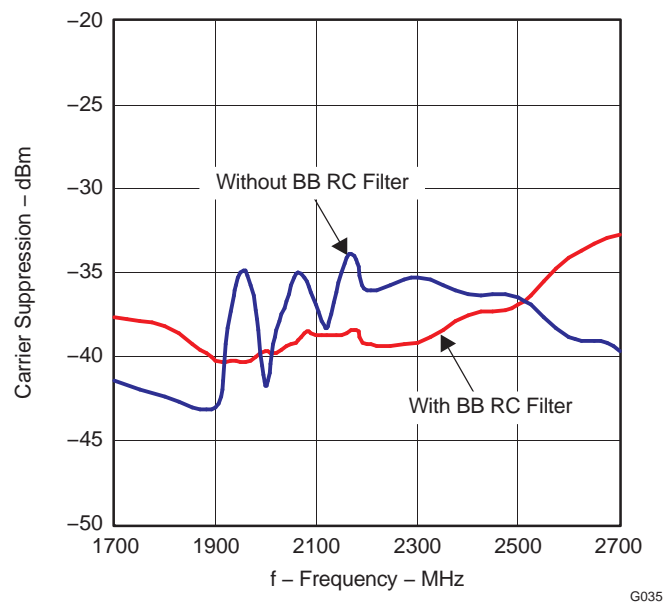

**Figure 46. Carrier Suppression Improvement With RC Filter**

### Adjusted (Optimized) Carrier Feedthrough

This differs from the unadjusted suppression number in that the baseband input dc offsets are iteratively adjusted around their theoretical value of VCM to yield the maximum suppression of the LO component in the output spectrum. This is measured in dBm.

### Unadjusted Sideband Suppression

This specification measures the amount by which the unwanted sideband of the input signal is suppressed in the output of the modulator, relative to the wanted sideband. If the amplitude and phase within the I and Q branch of the modulator were perfectly matched, the unwanted sideband (or image) would be naturally suppressed. Amplitude and phase imbalance in the I and Q branches results in the increase of the unwanted sideband. This parameter is measured in dBc relative to the desired sideband.

### Adjusted (Optimized) Sideband Suppression

This differs from the unadjusted sideband suppression in that the gain and phase of the baseband inputs are iteratively adjusted around their theoretical values to maximize the amount of sideband suppression. This is measured in dBc.

## Suppressions Over Temperature

This specification assumes that the user has gone through the optimization process for the suppression in question, and set the optimal settings for the I, Q inputs. This specification then measures the suppression when temperature conditions change after the initial calibration is done.

Figure 47 shows a simulated output and illustrates the respective definitions of various terms used in this data sheet.

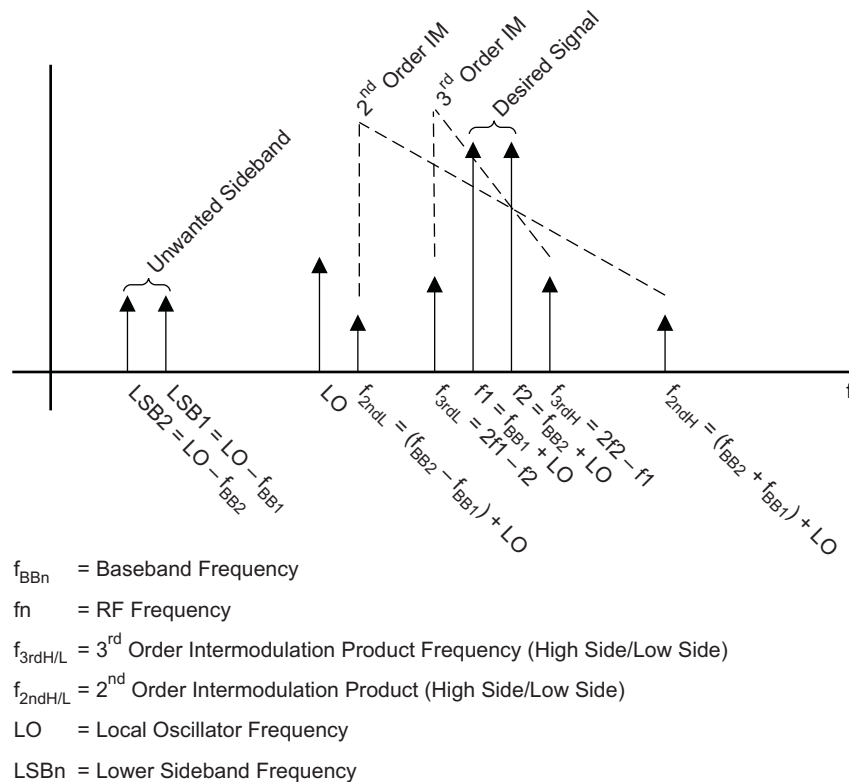

M0104-01

**Figure 47. Graphical Illustration of Common Terms**



## REVISION HISTORY

NOTE: Page numbers for previous revisions may differ from page numbers in the current version.

<b>Changes from Revision A (June, 2008) to Revision B</b>	<b>Page</b>
• Added electrostatic discharge parameters to Absolute Maximum Ratings table .....	3
• Added <i>ESD Sensitivity</i> section .....	18
<b>Changes from Original (March 2008) to Revision A</b>	<b>Page</b>
• Added ACPR graph to Typical Characteristics based on customers' requests .....	16
• Added ACPR graph to Typical Characteristics based on customers' requests .....	16

**PACKAGING INFORMATION**

Orderable Device	Status (1)	Package Type	Package Drawing	Pins	Package Qty	Eco Plan (2)	Lead/Ball Finish	MSL Peak Temp (3)	Op Temp (°C)	Top-Side Markings (4)	Samples
TRF370317IRGER	ACTIVE	VQFN	RGE	24	3000	Green (RoHS & no Sb/Br)	CU NIPDAU	Level-2-260C-1 YEAR	-40 to 85	TRF37 0317	<a href="#">Samples</a>
TRF370317IRGERG4	ACTIVE	VQFN	RGE	24	3000	Green (RoHS & no Sb/Br)	CU NIPDAU	Level-2-260C-1 YEAR	-40 to 85	TRF37 0317	<a href="#">Samples</a>
TRF370317IRGET	ACTIVE	VQFN	RGE	24	250	Green (RoHS & no Sb/Br)	CU NIPDAU	Level-2-260C-1 YEAR	-40 to 85	TRF37 0317	<a href="#">Samples</a>
TRF370317IRGETG4	ACTIVE	VQFN	RGE	24	250	Green (RoHS & no Sb/Br)	CU NIPDAU	Level-2-260C-1 YEAR	-40 to 85	TRF37 0317	<a href="#">Samples</a>

(1) The marketing status values are defined as follows:

**ACTIVE:** Product device recommended for new designs.

**LIFEBUY:** TI has announced that the device will be discontinued, and a lifetime-buy period is in effect.

**NRND:** Not recommended for new designs. Device is in production to support existing customers, but TI does not recommend using this part in a new design.

**PREVIEW:** Device has been announced but is not in production. Samples may or may not be available.

**OBSELETE:** TI has discontinued the production of the device.

(2) Eco Plan - The planned eco-friendly classification: Pb-Free (RoHS), Pb-Free (RoHS Exempt), or Green (RoHS & no Sb/Br) - please check <http://www.ti.com/productcontent> for the latest availability information and additional product content details.

**TBD:** The Pb-Free/Green conversion plan has not been defined.

**Pb-Free (RoHS):** TI's terms "Lead-Free" or "Pb-Free" mean semiconductor products that are compatible with the current RoHS requirements for all 6 substances, including the requirement that lead not exceed 0.1% by weight in homogeneous materials. Where designed to be soldered at high temperatures, TI Pb-Free products are suitable for use in specified lead-free processes.

**Pb-Free (RoHS Exempt):** This component has a RoHS exemption for either 1) lead-based flip-chip solder bumps used between the die and package, or 2) lead-based die adhesive used between the die and leadframe. The component is otherwise considered Pb-Free (RoHS compatible) as defined above.

**Green (RoHS & no Sb/Br):** TI defines "Green" to mean Pb-Free (RoHS compatible), and free of Bromine (Br) and Antimony (Sb) based flame retardants (Br or Sb do not exceed 0.1% by weight in homogeneous material)

(3) MSL, Peak Temp. -- The Moisture Sensitivity Level rating according to the JEDEC industry standard classifications, and peak solder temperature.

(4) Multiple Top-Side Markings will be inside parentheses. Only one Top-Side Marking contained in parentheses and separated by a "~" will appear on a device. If a line is indented then it is a continuation of the previous line and the two combined represent the entire Top-Side Marking for that device.

**Important Information and Disclaimer:** The information provided on this page represents TI's knowledge and belief as of the date that it is provided. TI bases its knowledge and belief on information provided by third parties, and makes no representation or warranty as to the accuracy of such information. Efforts are underway to better integrate information from third parties. TI has taken and continues to take reasonable steps to provide representative and accurate information but may not have conducted destructive testing or chemical analysis on incoming materials and chemicals. TI and TI suppliers consider certain information to be proprietary, and thus CAS numbers and other limited information may not be available for release.

In no event shall TI's liability arising out of such information exceed the total purchase price of the TI part(s) at issue in this document sold by TI to Customer on an annual basis.



**TAPE AND REEL INFORMATION**

**QUADRANT ASSIGNMENTS FOR PIN 1 ORIENTATION IN TAPE**

\*All dimensions are nominal

Device	Package Type	Package Drawing	Pins	SPQ	Reel Diameter (mm)	Reel Width W1 (mm)	A0 (mm)	B0 (mm)	K0 (mm)	P1 (mm)	W (mm)	Pin1 Quadrant
TRF370317IRGER	VQFN	RGE	24	3000	330.0	12.4	4.3	4.3	1.5	8.0	12.0	Q1
TRF370317IRGET	VQFN	RGE	24	250	180.0	12.4	4.3	4.3	1.5	8.0	12.0	Q1

**TAPE AND REEL BOX DIMENSIONS**

\*All dimensions are nominal

Device	Package Type	Package Drawing	Pins	SPQ	Length (mm)	Width (mm)	Height (mm)
TRF370317IRGER	VQFN	RGE	24	3000	338.1	338.1	20.6
TRF370317IRGET	VQFN	RGE	24	250	210.0	185.0	35.0

RGE (S-PVQFN-N24)

PLASTIC QUAD FLATPACK NO-LEAD



4204104/G 07/11

- NOTES:
- All linear dimensions are in millimeters. Dimensioning and tolerancing per ASME Y14.5M-1994.
  - This drawing is subject to change without notice.
  - Quad Flatpack, No-Leads (QFN) package configuration.
  - The package thermal pad must be soldered to the board for thermal and mechanical performance.
  - See the additional figure in the Product Data Sheet for details regarding the exposed thermal pad features and dimensions.
  - Falls within JEDEC MO-220.

## THERMAL PAD MECHANICAL DATA

RGE (S-PVQFN-N24)

PLASTIC QUAD FLATPACK NO-LEAD

### THERMAL INFORMATION

This package incorporates an exposed thermal pad that is designed to be attached directly to an external heatsink. The thermal pad must be soldered directly to the printed circuit board (PCB). After soldering, the PCB can be used as a heatsink. In addition, through the use of thermal vias, the thermal pad can be attached directly to the appropriate copper plane shown in the electrical schematic for the device, or alternatively, can be attached to a special heatsink structure designed into the PCB. This design optimizes the heat transfer from the integrated circuit (IC).

For information on the Quad Flatpack No-Lead (QFN) package and its advantages, refer to Application Report, QFN/SON PCB Attachment, Texas Instruments Literature No. SLUA271. This document is available at [www.ti.com](http://www.ti.com).

The exposed thermal pad dimensions for this package are shown in the following illustration.

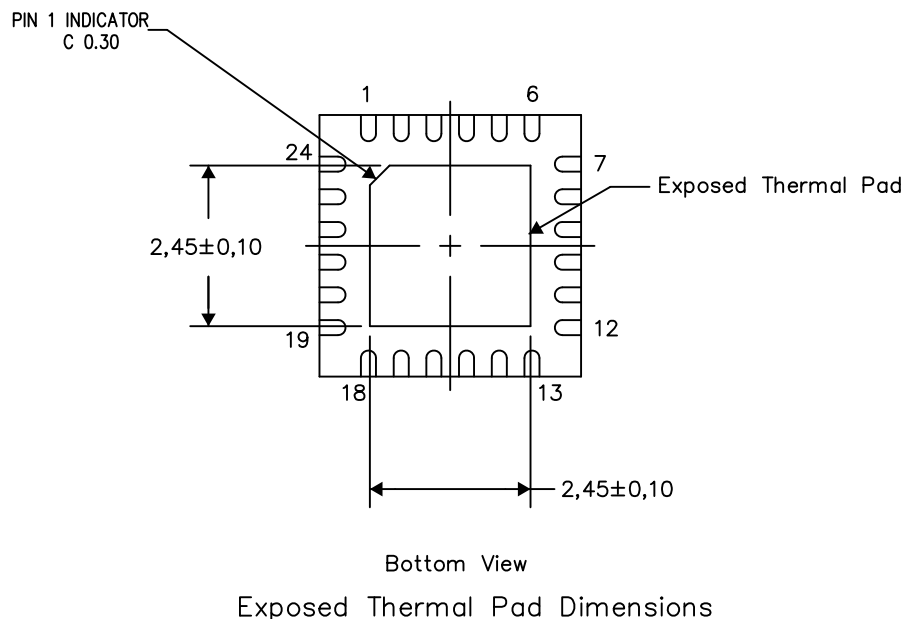

4206344-3/AC 03/13

NOTES: A. All linear dimensions are in millimeters

RGE (S-PVQFN-N24)

PLASTIC QUAD FLATPACK NO-LEAD

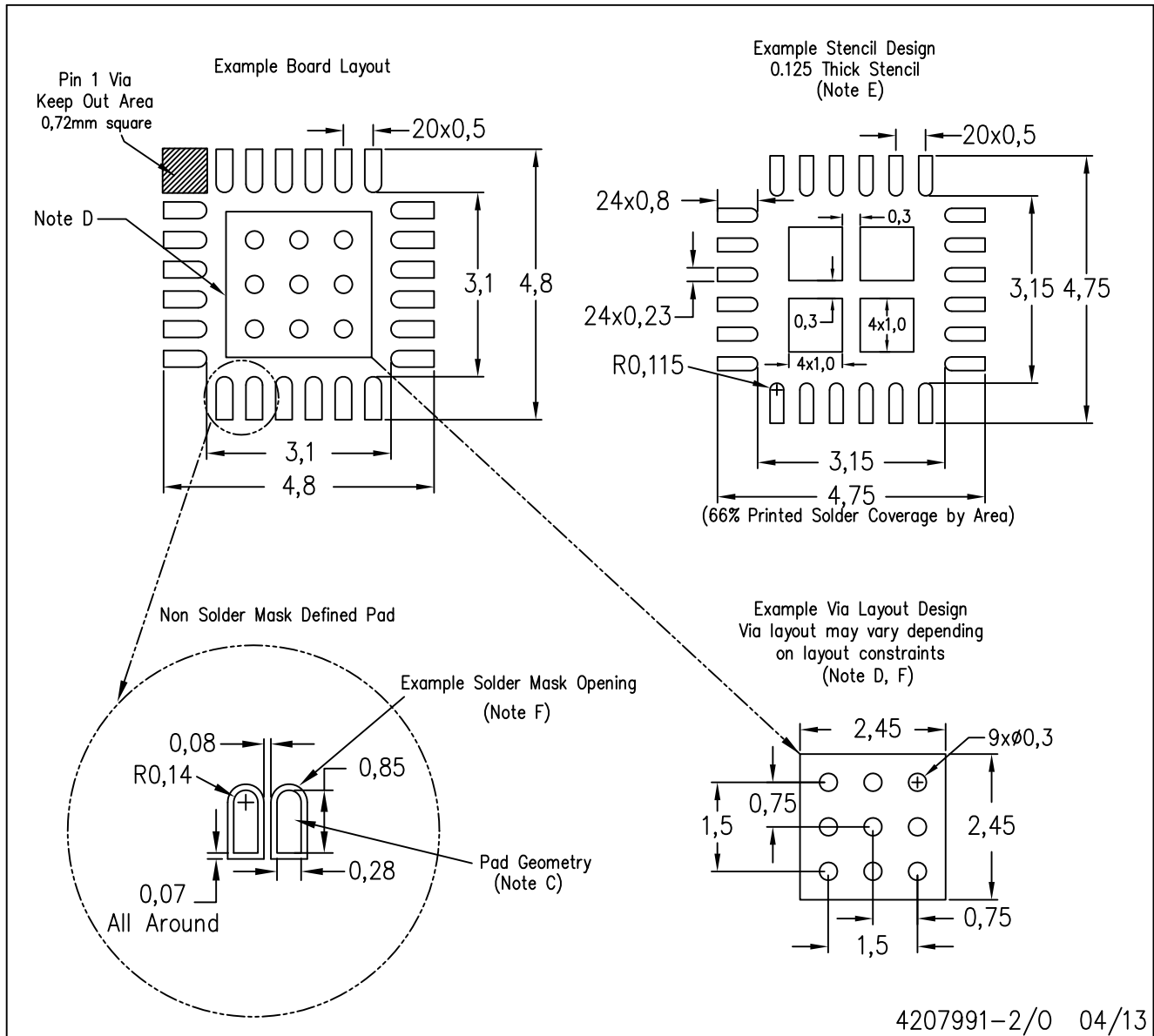

- NOTES:
- All linear dimensions are in millimeters.
  - This drawing is subject to change without notice.
  - Publication IPC-7351 is recommended for alternate designs.
  - This package is designed to be soldered to a thermal pad on the board. Refer to Application Note, Quad Flat-Pack Packages, Texas Instruments Literature No. SLUA271, and also the Product Data Sheets for specific thermal information, via requirements, and recommended board layout. These documents are available at [www.ti.com](http://www.ti.com) <<http://www.ti.com>>.
  - Laser cutting apertures with trapezoidal walls and also rounding corners will offer better paste release. Customers should contact their board assembly site for stencil design recommendations. Refer to IPC 7525 for stencil design considerations.
  - Customers should contact their board fabrication site for recommended solder mask tolerances and via tenting recommendations for vias placed in the thermal pad.



## IMPORTANT NOTICE

Texas Instruments Incorporated and its subsidiaries (TI) reserve the right to make corrections, enhancements, improvements and other changes to its semiconductor products and services per JESD46, latest issue, and to discontinue any product or service per JESD48, latest issue. Buyers should obtain the latest relevant information before placing orders and should verify that such information is current and complete. All semiconductor products (also referred to herein as "components") are sold subject to TI's terms and conditions of sale supplied at the time of order acknowledgment.

TI warrants performance of its components to the specifications applicable at the time of sale, in accordance with the warranty in TI's terms and conditions of sale of semiconductor products. Testing and other quality control techniques are used to the extent TI deems necessary to support this warranty. Except where mandated by applicable law, testing of all parameters of each component is not necessarily performed.

TI assumes no liability for applications assistance or the design of Buyers' products. Buyers are responsible for their products and applications using TI components. To minimize the risks associated with Buyers' products and applications, Buyers should provide adequate design and operating safeguards.

TI does not warrant or represent that any license, either express or implied, is granted under any patent right, copyright, mask work right, or other intellectual property right relating to any combination, machine, or process in which TI components or services are used. Information published by TI regarding third-party products or services does not constitute a license to use such products or services or a warranty or endorsement thereof. Use of such information may require a license from a third party under the patents or other intellectual property of the third party, or a license from TI under the patents or other intellectual property of TI.

Reproduction of significant portions of TI information in TI data books or data sheets is permissible only if reproduction is without alteration and is accompanied by all associated warranties, conditions, limitations, and notices. TI is not responsible or liable for such altered documentation. Information of third parties may be subject to additional restrictions.

Resale of TI components or services with statements different from or beyond the parameters stated by TI for that component or service voids all express and any implied warranties for the associated TI component or service and is an unfair and deceptive business practice. TI is not responsible or liable for any such statements.

Buyer acknowledges and agrees that it is solely responsible for compliance with all legal, regulatory and safety-related requirements concerning its products, and any use of TI components in its applications, notwithstanding any applications-related information or support that may be provided by TI. Buyer represents and agrees that it has all the necessary expertise to create and implement safeguards which anticipate dangerous consequences of failures, monitor failures and their consequences, lessen the likelihood of failures that might cause harm and take appropriate remedial actions. Buyer will fully indemnify TI and its representatives against any damages arising out of the use of any TI components in safety-critical applications.

In some cases, TI components may be promoted specifically to facilitate safety-related applications. With such components, TI's goal is to help enable customers to design and create their own end-product solutions that meet applicable functional safety standards and requirements. Nonetheless, such components are subject to these terms.

No TI components are authorized for use in FDA Class III (or similar life-critical medical equipment) unless authorized officers of the parties have executed a special agreement specifically governing such use.

Only those TI components which TI has specifically designated as military grade or "enhanced plastic" are designed and intended for use in military/aerospace applications or environments. Buyer acknowledges and agrees that any military or aerospace use of TI components which have **not** been so designated is solely at the Buyer's risk, and that Buyer is solely responsible for compliance with all legal and regulatory requirements in connection with such use.

TI has specifically designated certain components as meeting ISO/TS16949 requirements, mainly for automotive use. In any case of use of non-designated products, TI will not be responsible for any failure to meet ISO/TS16949.

### Products

Audio	<a href="http://www.ti.com/audio">www.ti.com/audio</a>
Amplifiers	<a href="http://amplifier.ti.com">amplifier.ti.com</a>
Data Converters	<a href="http://dataconverter.ti.com">dataconverter.ti.com</a>
DLP® Products	<a href="http://www.dlp.com">www.dlp.com</a>
DSP	<a href="http://dsp.ti.com">dsp.ti.com</a>
Clocks and Timers	<a href="http://www.ti.com/clocks">www.ti.com/clocks</a>
Interface	<a href="http://interface.ti.com">interface.ti.com</a>
Logic	<a href="http://logic.ti.com">logic.ti.com</a>
Power Mgmt	<a href="http://power.ti.com">power.ti.com</a>
Microcontrollers	<a href="http://microcontroller.ti.com">microcontroller.ti.com</a>
RFID	<a href="http://www.ti-rfid.com">www.ti-rfid.com</a>
OMAP Applications Processors	<a href="http://www.ti.com/omap">www.ti.com/omap</a>
Wireless Connectivity	<a href="http://www.ti.com/wirelessconnectivity">www.ti.com/wirelessconnectivity</a>

### Applications

Automotive and Transportation	<a href="http://www.ti.com/automotive">www.ti.com/automotive</a>
Communications and Telecom	<a href="http://www.ti.com/communications">www.ti.com/communications</a>
Computers and Peripherals	<a href="http://www.ti.com/computers">www.ti.com/computers</a>
Consumer Electronics	<a href="http://www.ti.com/consumer-apps">www.ti.com/consumer-apps</a>
Energy and Lighting	<a href="http://www.ti.com/energy">www.ti.com/energy</a>
Industrial	<a href="http://www.ti.com/industrial">www.ti.com/industrial</a>
Medical	<a href="http://www.ti.com/medical">www.ti.com/medical</a>
Security	<a href="http://www.ti.com/security">www.ti.com/security</a>
Space, Avionics and Defense	<a href="http://www.ti.com/space-avionics-defense">www.ti.com/space-avionics-defense</a>
Video and Imaging	<a href="http://www.ti.com/video">www.ti.com/video</a>

### TI E2E Community

[e2e.ti.com](http://e2e.ti.com)