

# TPS76130, TPS76132, TPS76133, TPS76138, TPS76150 LOW-POWER 100-mA LOW-DROPOUT LINEAR REGULATORS

SLVS178B – DECEMBER 1998 – REVISED MAY 2001

- 100-mA Low-Dropout Regulator
- Fixed Output Voltage Options: 5 V, 3.8 V, 3.3 V, 3.2 V, and 3 V
- Dropout Typically 170 mV at 100-mA
- Thermal Protection
- Less Than 1  $\mu$ A Quiescent Current in Shutdown
- $-40^{\circ}\text{C}$  to  $125^{\circ}\text{C}$  Operating Junction Temperature Range
- 5-Pin SOT-23 (DBV) Package
- ESD Protection Verified to 1.5 KV Human Body Model (HBM) per MIL-STD-883C

DBV PACKAGE  
(TOP VIEW)

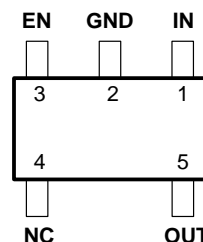

NC – No internal connection

## description

The TPS761xx is a 100 mA, low dropout (LDO) voltage regulator designed specifically for battery-powered applications. A proprietary BiCMOS fabrication process allows the TPS761xx to provide outstanding performance in all specifications critical to battery-powered operation.

The TPS761xx is available in a space-saving SOT-23 (DBV) package and operates over a junction temperature range of  $-40^{\circ}\text{C}$  to  $125^{\circ}\text{C}$ .

AVAILABLE OPTIONS

T <sub>J</sub>	VOLTAGE	PACKAGE	PART NUMBER		SYMBOL
$-40^{\circ}\text{C}$ to $125^{\circ}\text{C}$	3 V	SOT-23 (DBV)	TPS76130DBVR†	TPS76130DBVT‡	PAEI
	3.2 V		TPS76132DBVR†	TPS76132DBVT‡	PAFI
	3.3 V		TPS76133DBVR†	TPS76133DBVT‡	PAII
	3.8 V		TPS76138DBVR†	TPS76138DBVT‡	PAKI
	5 V		TPS76150DBVR†	TPS76150DBVT‡	PALI

† The DBVR passive indicates tape and reel of 3000 parts.

‡ The DBVT passive indicates tape and reel of 250 parts.

## functional block diagram

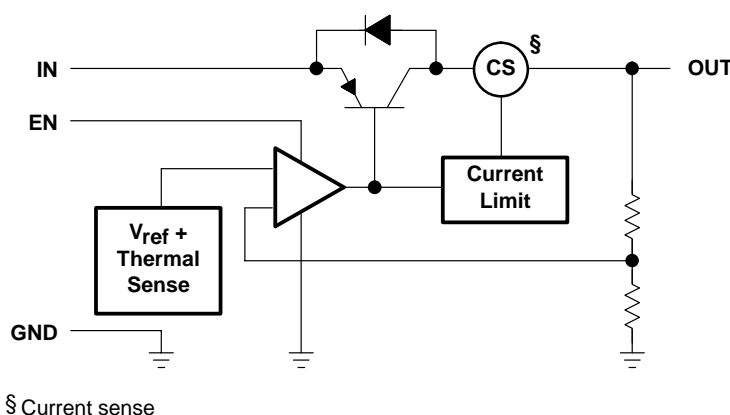

Please be aware that an important notice concerning availability, standard warranty, and use in critical applications of Texas Instruments semiconductor products and disclaimers thereto appears at the end of this data sheet.

PRODUCTION DATA information is current as of publication date. Products conform to specifications per the terms of Texas Instruments standard warranty. Production processing does not necessarily include testing of all parameters.

**TEXAS  
INSTRUMENTS**

POST OFFICE BOX 655303 • DALLAS, TEXAS 75265

Copyright © 2001, Texas Instruments Incorporated

# TPS76130, TPS76132, TPS76133, TPS76138, TPS76150

## LOW-POWER 100-mA LOW-DROPOUT LINEAR REGULATORS

SLVS178B – DECEMBER 1998 – REVISED MAY 2001

### Terminal Functions

TERMINAL NAME	NO.	I/O	DESCRIPTION
EN	3	I	Enable input
GND	2		Ground
IN	1	I	Input voltage
NC	4		No connection
OUT	5	O	Regulated output voltage

### absolute maximum ratings over operating free-air temperature range (unless otherwise noted)†

Input voltage range, $V_I$ (see Note 1)	–0.3 V to 16 V
Voltage range at EN	–0.3 V to $V_I + 0.3$ V
Peak output current	internally limited
Continuous total dissipation	See Dissipation Rating Table
Operating junction temperature range, $T_J$	–40°C to 150°C
Storage temperature range, $T_{stg}$	–65°C to 150°C
ESD rating, HBM	1.5 kV

† Stresses beyond those listed under “absolute maximum ratings” may cause permanent damage to the device. These are stress ratings only, and functional operation of the device at these or any other conditions beyond those indicated under “recommended operating conditions” is not implied. Exposure to absolute-maximum-rated conditions for extended periods may affect device reliability.

NOTE 1: All voltages are with respect to device GND pin.

DISSIPATION RATING TABLE

BOARD	PACKAGE	$R_{\theta JC}$	$R_{\theta JA}$	DERATING FACTOR ABOVE $T_A = 25^\circ\text{C}$	$T_A \leq 25^\circ\text{C}$ POWER RATING	$T_A = 70^\circ\text{C}$ POWER RATING	$T_A = 85^\circ\text{C}$ POWER RATING
Low K‡	DBV	65.8 °C/W	259 °C/W	3.9 mW/°C	386 mW	212 mW	154 mW
High K§	DBV	65.8 °C/W	180 °C/W	5.6 mW/°C	555 mW	305 mW	222 mW

‡ The JEDEC Low K (1s) board design used to derive this data was a 3 inch x 3 inch, two layer board with 2 ounce copper traces on top of the board.

§ The JEDEC High K (2s2p) board design used to derive this data was a 3 inch x 3 inch, multilayer board with 1 ounce internal power and ground planes and 2 ounce copper traces on top and bottom of the board.

### recommended operating conditions

	MIN	NOM	MAX	UNIT
Input voltage, $V_I$	TPS76130	3.35	16	V
	TPS76132	3.58	16	
	TPS76133	3.68	16	
	TPS76138	4.18	16	
	TPS76150	5.38	16	
Continuous output current, $I_O$	0		100	mA
Operating junction temperature, $T_J$	–40		125	°C



POST OFFICE BOX 655303 • DALLAS, TEXAS 75265

# TPS76130, TPS76132, TPS76133, TPS76138, TPS76150 LOW-POWER 100-mA LOW-DROPOUT LINEAR REGULATORS

SLVS178B – DECEMBER 1998 – REVISED MAY 2001

electrical characteristics over recommended operating free-air temperature range,  
 $V_I = V_{O(\text{typ})} + 1 \text{ V}$ ,  $I_O = 1 \text{ mA}$ ,  $EN = V_I$ ,  $C_O = 4.7 \mu\text{F}$  (unless otherwise noted)

PARAMETER		TEST CONDITIONS	MIN	TYP	MAX	UNIT	
$V_O$	Output voltage	TPS76130	$T_J = 25^\circ\text{C}$	2.96	3	3.04	V
		$T_J = 25^\circ\text{C}$ , $1 \text{ mA} < I_O < 100 \text{ mA}$	2.9		3.04		
		$1 \text{ mA} < I_O < 100 \text{ mA}$	2.89		3.07		
	Output voltage	TPS76132	$T_J = 25^\circ\text{C}$	3.16	3.2	3.24	V
		$T_J = 25^\circ\text{C}$ , $1 \text{ mA} < I_O < 100 \text{ mA}$	3.11		3.24		
		$1 \text{ mA} < I_O < 100 \text{ mA}$	3.08		3.3		
	Output voltage	TPS76133	$T_J = 25^\circ\text{C}$	3.26	3.3	3.34	V
		$T_J = 25^\circ\text{C}$ , $1 \text{ mA} < I_O < 100 \text{ mA}$	3.21		3.34		
		$1 \text{ mA} < I_O < 100 \text{ mA}$	3.18		3.4		
	Output voltage	TPS76138	$T_J = 25^\circ\text{C}$	3.76	3.8	3.84	V
		$T_J = 25^\circ\text{C}$ , $1 \text{ mA} < I_O < 100 \text{ mA}$	3.71		3.84		
		$1 \text{ mA} < I_O < 100 \text{ mA}$	3.68		3.9		
	Output voltage	TPS76150	$T_J = 25^\circ\text{C}$	4.95	5	5.05	V
		$T_J = 25^\circ\text{C}$ , $1 \text{ mA} < I_O < 100 \text{ mA}$	4.88		5.05		
		$1 \text{ mA} < I_O < 100 \text{ mA}$	4.86		5.1		
$I_I(\text{standby})$	Standby current	$EN = 0 \text{ V}$			1	$\mu\text{A}$	
Quiescent current (GND current)		$I_O = 0 \text{ mA}$ , $T_J = 25^\circ\text{C}$		90	115	$\mu\text{A}$	
		$I_O = 0 \text{ mA}$			130		
		$I_O = 1 \text{ mA}$ , $T_J = 25^\circ\text{C}$		100	130		
		$I_O = 1 \text{ mA}$			170		
		$I_O = 10 \text{ mA}$ , $T_J = 25^\circ\text{C}$		190	220		
		$I_O = 10 \text{ mA}$			260		
		$I_O = 50 \text{ mA}$ , $T_J = 25^\circ\text{C}$		850	1100		
		$I_O = 50 \text{ mA}$			1200		
		$I_O = 100 \text{ mA}$ , $T_J = 25^\circ\text{C}$		2600	3600		
		$I_O = 100 \text{ mA}$			4000		
Input regulation	TPS76130	$4 \text{ V} < V_I < 16$ , $I_O = 1 \text{ mA}$		3	10	mV	
	TPS76132	$4.2 \text{ V} < V_I < 16$ , $I_O = 1 \text{ mA}$		3	10		
	TPS76133	$4.3 \text{ V} < V_I < 16$ , $I_O = 1 \text{ mA}$		3	10		
	TPS76138	$4.8 \text{ V} < V_I < 16$ , $I_O = 1 \text{ mA}$		3	10		
	TPS76150	$6 \text{ V} < V_I < 16$ , $I_O = 1 \text{ mA}$		3	10		
$V_N$	Output noise voltage	$BW = 300 \text{ Hz to } 50 \text{ kHz}$ $C_O = 10 \mu\text{F}$ , $T_J = 25^\circ\text{C}$		190		$\mu\text{Vrms}$	
	Ripple rejection	$f = 1 \text{ kHz}$ , $C_O = 10 \mu\text{F}$ , $T_J = 25^\circ\text{C}$		63		dB	



# TPS76130, TPS76132, TPS76133, TPS76138, TPS76150 LOW-POWER 100-mA LOW-DROPOUT LINEAR REGULATORS

SLVS178B – DECEMBER 1998 – REVISED MAY 2001

electrical characteristics over recommended operating free-air temperature range,  
 $V_I = V_O(\text{typ}) + 1 \text{ V}$ ,  $I_O = 1 \text{ mA}$ ,  $EN = V_I$ ,  $C_O = 4.7 \mu\text{F}$  (unless otherwise noted) (continued)

PARAMETER	TEST CONDITIONS	MIN	TYP	MAX	UNIT
Dropout voltage	$I_O = 0 \text{ mA}$ , $T_J = 25^\circ\text{C}$		1	3	mV
	$I_O = 0 \text{ mA}$			5	
	$I_O = 1 \text{ mA}$ , $T_J = 25^\circ\text{C}$		7	10	
	$I_O = 1 \text{ mA}$			15	
	$I_O = 10 \text{ mA}$ , $T_J = 25^\circ\text{C}$		40	60	
	$I_O = 10 \text{ mA}$			90	
	$I_O = 50 \text{ mA}$ , $T_J = 25^\circ\text{C}$		120	150	
	$I_O = 50 \text{ mA}$			180	
	$I_O = 100 \text{ mA}$ , $T_J = 25^\circ\text{C}$		170	240	
	$I_O = 100 \text{ mA}$			280	
Peak output current/current limit		100	125	135	mA
High level enable input		2			V
Low level enable input				0.8	V
$I_I$ Input current (EN)	$EN = 0 \text{ V}$	-1	0	1	$\mu\text{A}$
	$EN = V_I$		2.5	5	

## TYPICAL CHARACTERISTICS

Table of Graphs

			FIGURE
$V_O$	Output voltage	vs Output current	1, 2, 3
		vs Free-air temperature	4, 5, 6
	Ground current	vs Free-air temperature	7, 8, 9
	Output noise	vs Frequency	10
$Z_O$	Output impedance	vs Frequency	11
$V_{DO}$	Dropout voltage	vs Free-air temperature	12
	Line transient response		13, 15
	Load transient response		14, 16



TYPICAL CHARACTERISTICS

TPS76130  
 OUTPUT VOLTAGE  
 vs  
 OUTPUT CURRENT

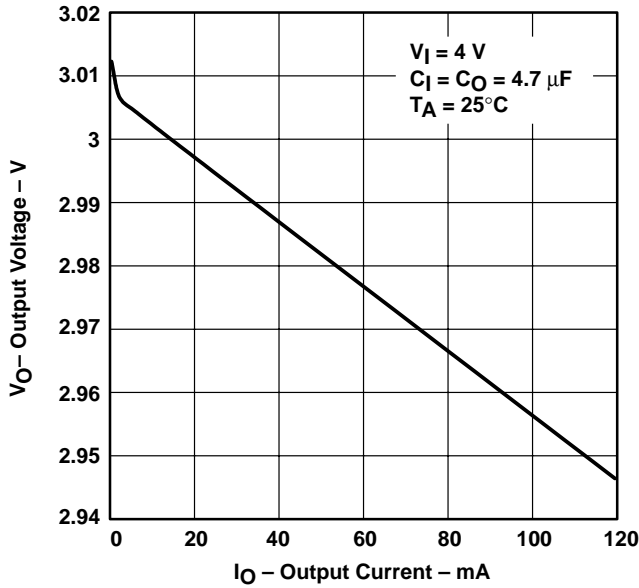

Figure 1

TPS76133  
 OUTPUT VOLTAGE  
 vs  
 OUTPUT CURRENT

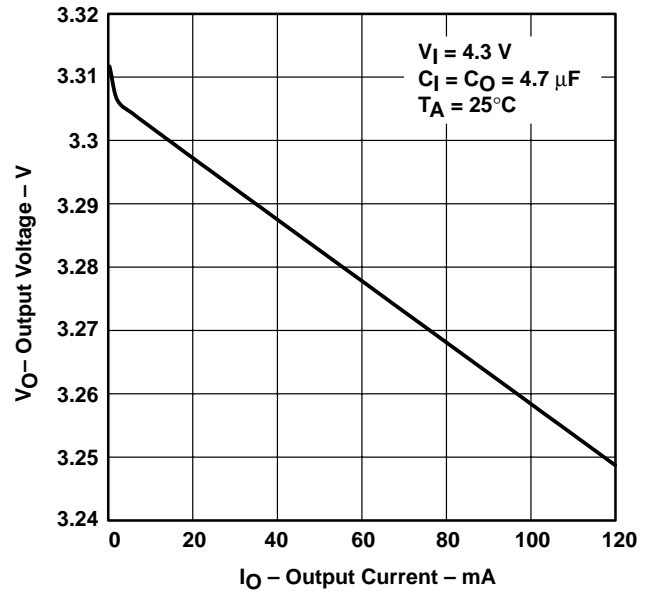

Figure 2

TPS76150  
 OUTPUT VOLTAGE  
 vs  
 OUTPUT CURRENT

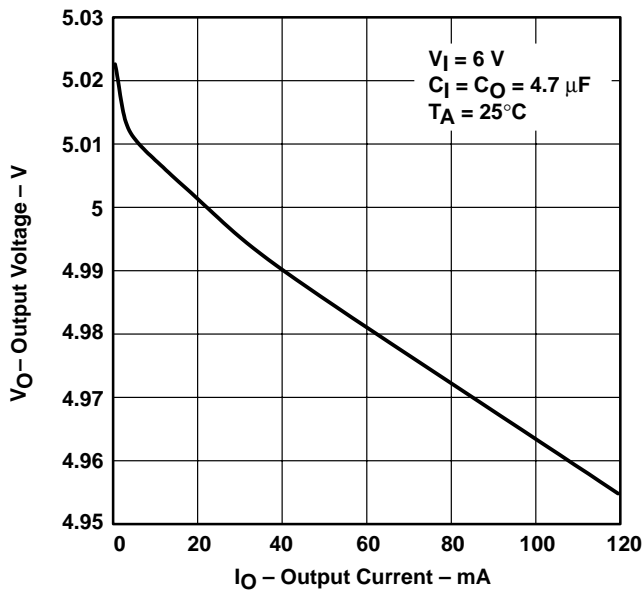

Figure 3

TPS76130  
 OUTPUT VOLTAGE  
 vs  
 FREE-AIR TEMPERATURE

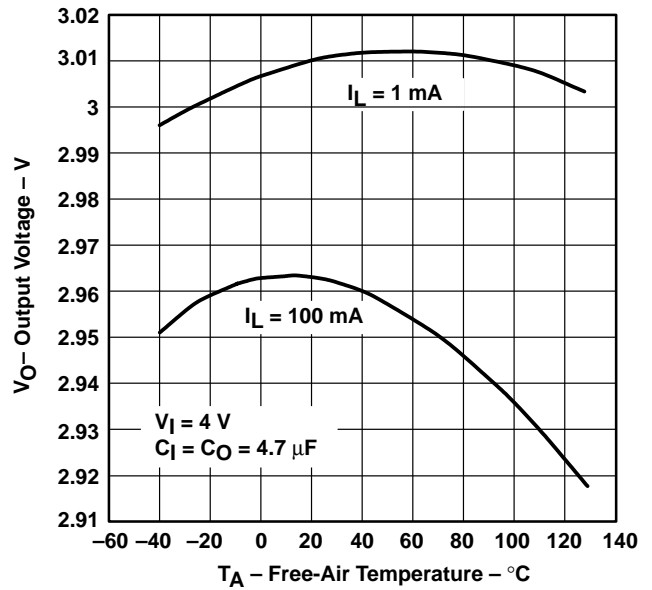

Figure 4

# TPS76130, TPS76132, TPS76133, TPS76138, TPS76150 LOW-POWER 100-mA LOW-DROPOUT LINEAR REGULATORS

SLVS178B – DECEMBER 1998 – REVISED MAY 2001

## TYPICAL CHARACTERISTICS

TPS76133  
OUTPUT VOLTAGE  
vs  
FREE-AIR TEMPERATURE

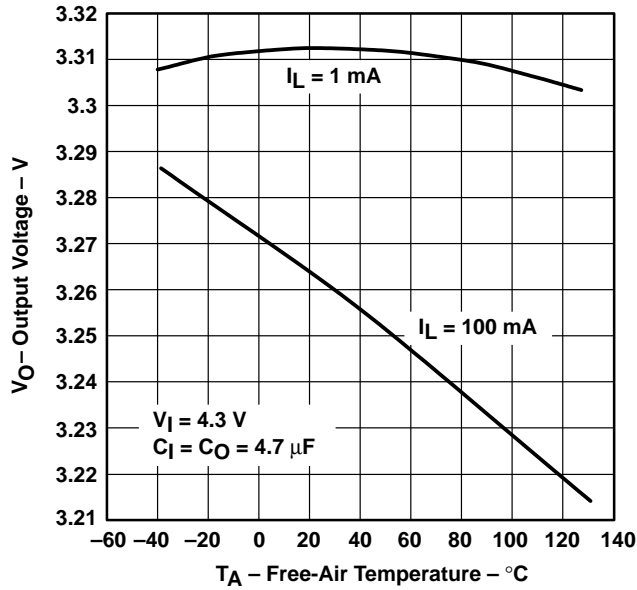

Figure 5

TPS76150  
OUTPUT VOLTAGE  
vs  
FREE-AIR TEMPERATURE

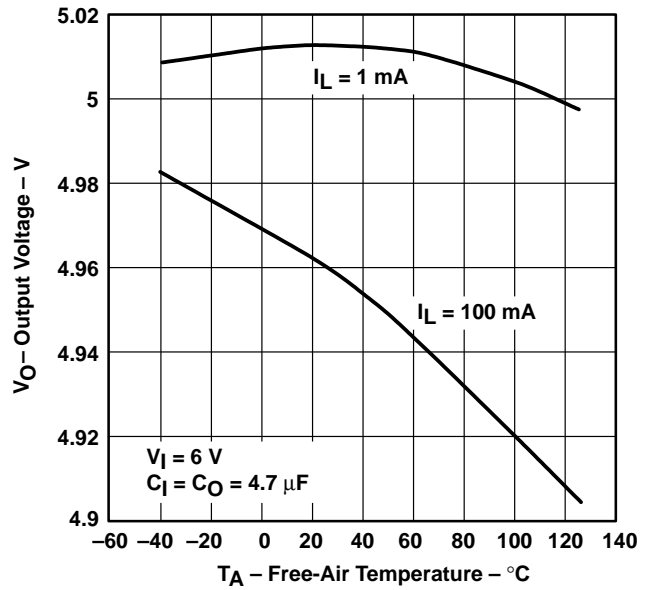

Figure 6

TPS76130  
GROUND CURRENT  
vs  
FREE-AIR TEMPERATURE

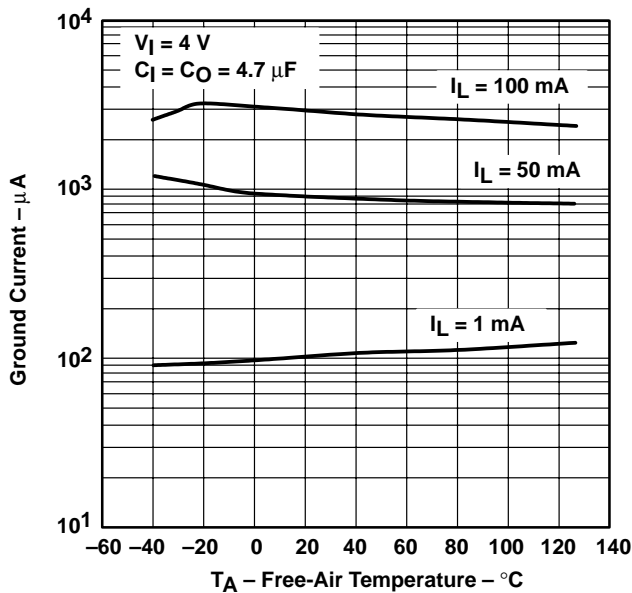

Figure 7

TPS76133  
GROUND CURRENT  
vs  
FREE-AIR TEMPERATURE

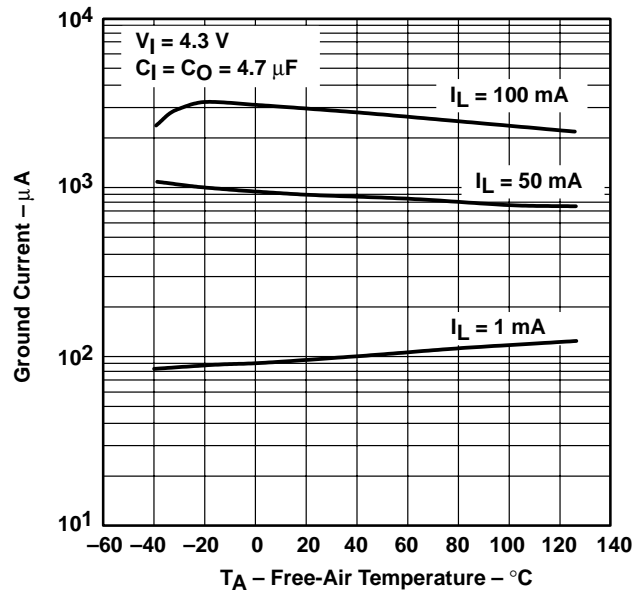

Figure 8



TYPICAL CHARACTERISTICS

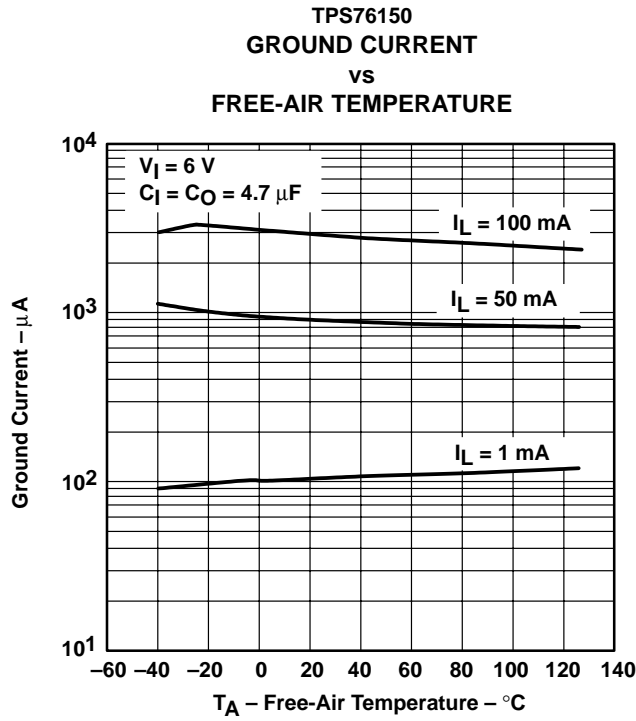

Figure 9

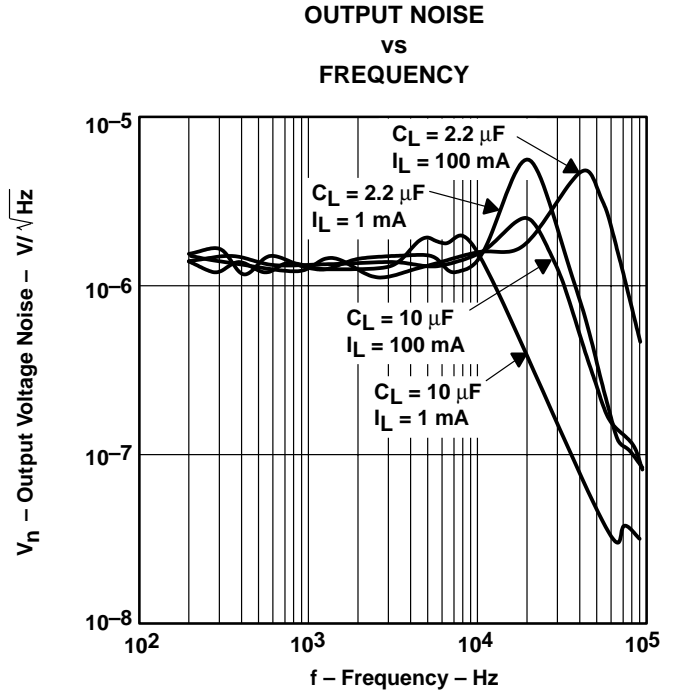

Figure 10

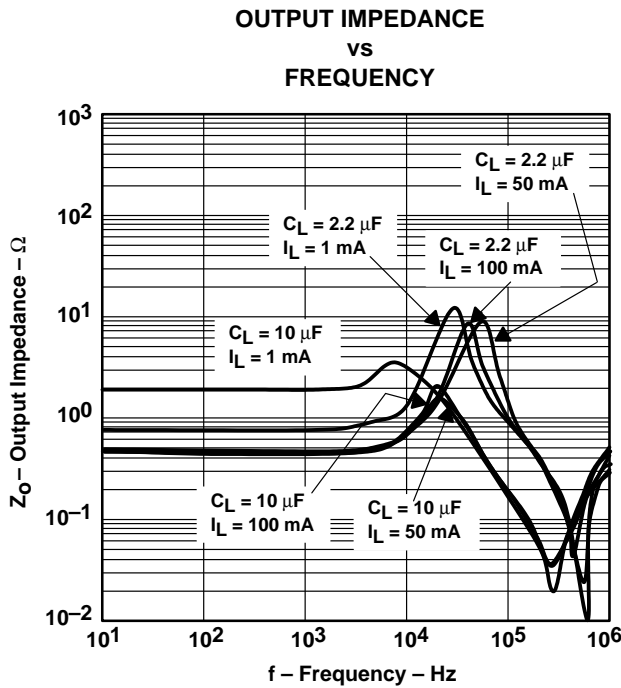

Figure 11

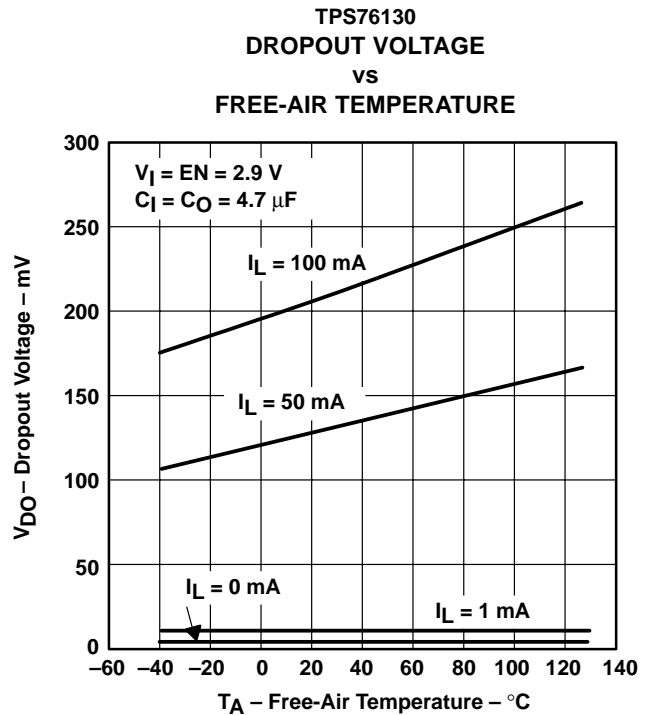

Figure 12

# TPS76130, TPS76132, TPS76133, TPS76138, TPS76150

## LOW-POWER 100-mA LOW-DROPOUT LINEAR REGULATORS

SLVS178B – DECEMBER 1998 – REVISED MAY 2001

### TYPICAL CHARACTERISTICS

**TPS76130**  
**LINE TRANSIENT RESPONSE**

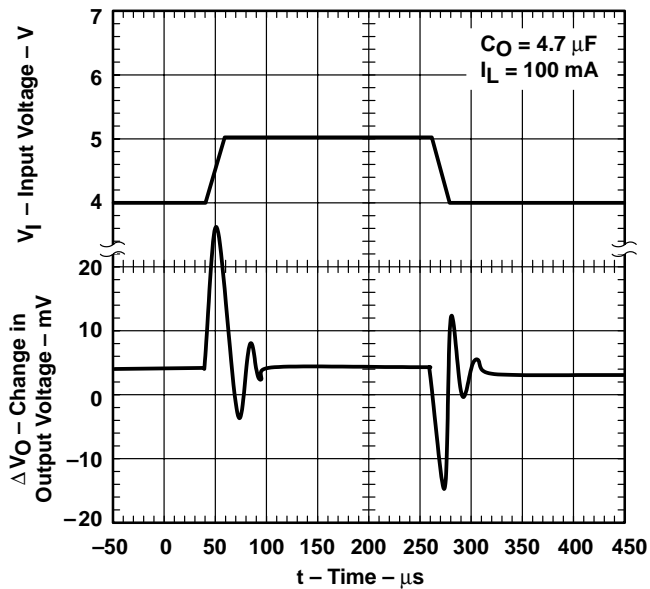

**Figure 13**

**TPS76130**  
**LOAD TRANSIENT RESPONSE**

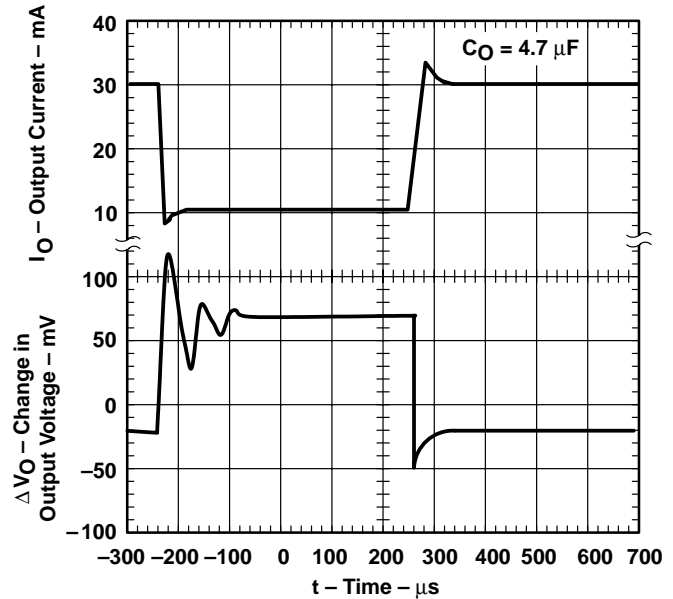

**Figure 14**

**TPS76150**  
**LINE TRANSIENT RESPONSE**

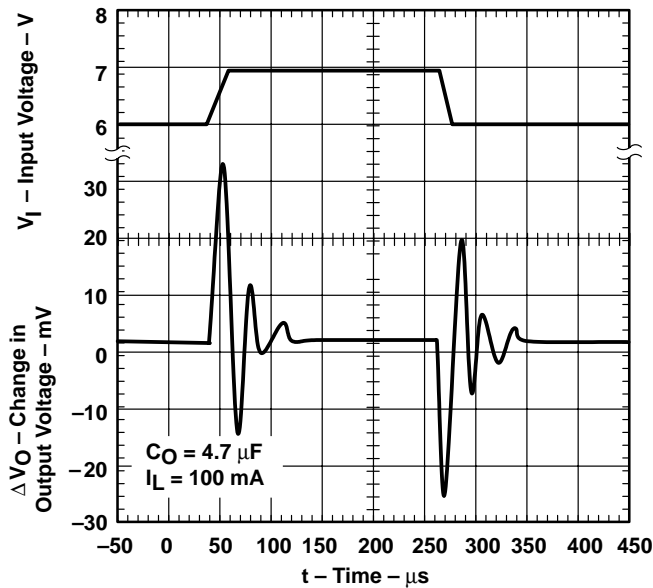

**Figure 15**

**TPS76150**  
**LOAD TRANSIENT RESPONSE**

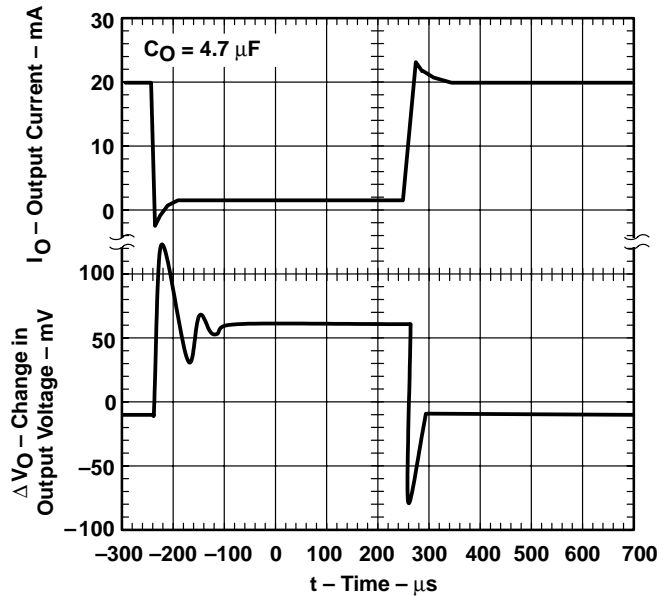

**Figure 16**





## APPLICATION INFORMATION

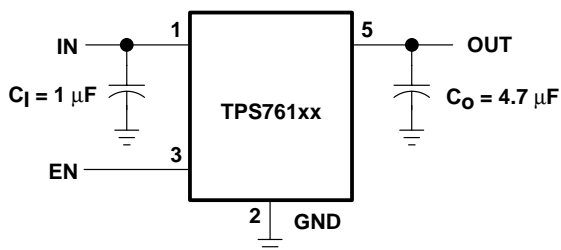

Figure 17. TPS761xx Typical Application

### over current protection

The over current protection circuit forces the TPS761xx into a constant current output mode when the load is excessive or the output is shorted to ground. Normal operation resumes when the fault condition is removed.

**NOTE:**

An overload or short circuit may also activate the over temperature protection if the fault condition persists.

### over temperature protection

The thermal protection system shuts the TPS761xx down when the junction temperature exceeds 160°C. The device recovers and operates normally when the temperature drops below 150°C.

### input capacitor

A 1- $\mu$ F or larger ceramic decoupling capacitor with short leads connected between IN and GND is recommended. The decoupling capacitor may be omitted if there is a 1  $\mu$ F or larger electrolytic capacitor connected between IN and GND and located reasonably close to the TPS761xx. However, the small ceramic device is desirable even when the larger capacitor is present, if there is a lot of high frequency noise present in the system.

### output capacitor

Like all low dropout regulators, the TPS761xx requires an output capacitor connected between OUT and GND to stabilize the internal control loop. The minimum recommended capacitance value is 4.7  $\mu$ F and the ESR (equivalent series resistance) must be between 0.1  $\Omega$  and 10  $\Omega$ . Solid tantalum electrolytic, aluminum electrolytic, and multilayer ceramic capacitors are all suitable, provided they meet the requirements described above. Most of the commercially available 4.7- $\mu$ F surface-mount solid-tantalum capacitors, including devices from Sprague, Kemet, and Nichicon, meet the ESR requirements stated above. Multilayer ceramic capacitors should have minimum values of 4.7  $\mu$ F over the full operating temperature range of the equipment.

### enable (EN)

A logic zero on the enable input shuts the TPS761xx off and reduces the supply current to less than 1  $\mu$ A. Pulling the enable input high causes normal operation to resume. If the enable feature is not used, EN should be connected to IN to keep the regulator on all of the time. The EN input must not be left floating.

### reverse current path

The power transistor used in the TPS761xx has an inherent diode connected between IN and OUT as shown in the functional block diagram. This diode conducts current from the OUT terminal to the IN terminal whenever IN is lower than OUT by a diode drop. This condition does not damage the TPS761xx provided the current is limited to 150 mA.

**PACKAGING INFORMATION**

Orderable Device	Status (1)	Package Type	Package Drawing	Pins	Package Qty	Eco Plan (2)	Lead/Ball Finish	MSL Peak Temp (3)	Op Temp (°C)	Top-Side Markings (4)	Samples
TPS76130DBVR	ACTIVE	SOT-23	DBV	5	3000	Green (RoHS & no Sb/Br)	CU NIPDAU	Level-1-260C-UNLIM		PAEI	<a href="#">Samples</a>
TPS76130DBVRG4	ACTIVE	SOT-23	DBV	5	3000	Green (RoHS & no Sb/Br)	CU NIPDAU	Level-1-260C-UNLIM		PAEI	<a href="#">Samples</a>
TPS76130DBVT	ACTIVE	SOT-23	DBV	5	250	Green (RoHS & no Sb/Br)	CU NIPDAU	Level-1-260C-UNLIM		PAEI	<a href="#">Samples</a>
TPS76130DBVTG4	ACTIVE	SOT-23	DBV	5	250	Green (RoHS & no Sb/Br)	CU NIPDAU	Level-1-260C-UNLIM		PAEI	<a href="#">Samples</a>
TPS76132DBVR	ACTIVE	SOT-23	DBV	5	3000	Green (RoHS & no Sb/Br)	CU NIPDAU	Level-1-260C-UNLIM		PAFI	<a href="#">Samples</a>
TPS76132DBVRG4	ACTIVE	SOT-23	DBV	5	3000	Green (RoHS & no Sb/Br)	CU NIPDAU	Level-1-260C-UNLIM		PAFI	<a href="#">Samples</a>
TPS76132DBVT	ACTIVE	SOT-23	DBV	5	250	Green (RoHS & no Sb/Br)	CU NIPDAU	Level-1-260C-UNLIM		PAFI	<a href="#">Samples</a>
TPS76132DBVTG4	ACTIVE	SOT-23	DBV	5	250	Green (RoHS & no Sb/Br)	CU NIPDAU	Level-1-260C-UNLIM		PAFI	<a href="#">Samples</a>
TPS76133DBVR	ACTIVE	SOT-23	DBV	5	3000	Green (RoHS & no Sb/Br)	CU NIPDAU	Level-1-260C-UNLIM		PAII	<a href="#">Samples</a>
TPS76133DBVRG4	ACTIVE	SOT-23	DBV	5	3000	Green (RoHS & no Sb/Br)	CU NIPDAU	Level-1-260C-UNLIM		PAII	<a href="#">Samples</a>
TPS76133DBVT	ACTIVE	SOT-23	DBV	5	250	Green (RoHS & no Sb/Br)	CU NIPDAU	Level-1-260C-UNLIM		PAII	<a href="#">Samples</a>
TPS76133DBVTG4	ACTIVE	SOT-23	DBV	5	250	Green (RoHS & no Sb/Br)	CU NIPDAU	Level-1-260C-UNLIM		PAII	<a href="#">Samples</a>
TPS76138DBVR	ACTIVE	SOT-23	DBV	5	3000	Green (RoHS & no Sb/Br)	CU NIPDAU	Level-1-260C-UNLIM		PAKI	<a href="#">Samples</a>
TPS76138DBVRG4	ACTIVE	SOT-23	DBV	5	3000	Green (RoHS & no Sb/Br)	CU NIPDAU	Level-1-260C-UNLIM		PAKI	<a href="#">Samples</a>
TPS76138DBVT	ACTIVE	SOT-23	DBV	5	250	Green (RoHS & no Sb/Br)	CU NIPDAU	Level-1-260C-UNLIM		PAKI	<a href="#">Samples</a>
TPS76138DBVTG4	ACTIVE	SOT-23	DBV	5	250	Green (RoHS & no Sb/Br)	CU NIPDAU	Level-1-260C-UNLIM		PAKI	<a href="#">Samples</a>
TPS76150DBVR	ACTIVE	SOT-23	DBV	5	3000	Green (RoHS & no Sb/Br)	CU NIPDAU	Level-1-260C-UNLIM		PALI	<a href="#">Samples</a>

Orderable Device	Status (1)	Package Type	Package Drawing	Pins	Package Qty	Eco Plan (2)	Lead/Ball Finish	MSL Peak Temp (3)	Op Temp (°C)	Top-Side Markings (4)	Samples
TPS76150DBVRG4	ACTIVE	SOT-23	DBV	5	3000	Green (RoHS & no Sb/Br)	CU NIPDAU	Level-1-260C-UNLIM		PALI	<a href="#">Samples</a>
TPS76150DBVT	ACTIVE	SOT-23	DBV	5	250	Green (RoHS & no Sb/Br)	CU NIPDAU	Level-1-260C-UNLIM		PALI	<a href="#">Samples</a>
TPS76150DBVTG4	ACTIVE	SOT-23	DBV	5	250	Green (RoHS & no Sb/Br)	CU NIPDAU	Level-1-260C-UNLIM		PALI	<a href="#">Samples</a>

(1) The marketing status values are defined as follows:

**ACTIVE:** Product device recommended for new designs.

**LIFEBUY:** TI has announced that the device will be discontinued, and a lifetime-buy period is in effect.

**NRND:** Not recommended for new designs. Device is in production to support existing customers, but TI does not recommend using this part in a new design.

**PREVIEW:** Device has been announced but is not in production. Samples may or may not be available.

**OBSOLETE:** TI has discontinued the production of the device.

(2) Eco Plan - The planned eco-friendly classification: Pb-Free (RoHS), Pb-Free (RoHS Exempt), or Green (RoHS & no Sb/Br) - please check <http://www.ti.com/productcontent> for the latest availability information and additional product content details.

**TBD:** The Pb-Free/Green conversion plan has not been defined.

**Pb-Free (RoHS):** TI's terms "Lead-Free" or "Pb-Free" mean semiconductor products that are compatible with the current RoHS requirements for all 6 substances, including the requirement that lead not exceed 0.1% by weight in homogeneous materials. Where designed to be soldered at high temperatures, TI Pb-Free products are suitable for use in specified lead-free processes.

**Pb-Free (RoHS Exempt):** This component has a RoHS exemption for either 1) lead-based flip-chip solder bumps used between the die and package, or 2) lead-based die adhesive used between the die and leadframe. The component is otherwise considered Pb-Free (RoHS compatible) as defined above.

**Green (RoHS & no Sb/Br):** TI defines "Green" to mean Pb-Free (RoHS compatible), and free of Bromine (Br) and Antimony (Sb) based flame retardants (Br or Sb do not exceed 0.1% by weight in homogeneous material)

(3) MSL, Peak Temp. -- The Moisture Sensitivity Level rating according to the JEDEC industry standard classifications, and peak solder temperature.

(4) Only one of markings shown within the brackets will appear on the physical device.

**Important Information and Disclaimer:** The information provided on this page represents TI's knowledge and belief as of the date that it is provided. TI bases its knowledge and belief on information provided by third parties, and makes no representation or warranty as to the accuracy of such information. Efforts are underway to better integrate information from third parties. TI has taken and continues to take reasonable steps to provide representative and accurate information but may not have conducted destructive testing or chemical analysis on incoming materials and chemicals. TI and TI suppliers consider certain information to be proprietary, and thus CAS numbers and other limited information may not be available for release.

In no event shall TI's liability arising out of such information exceed the total purchase price of the TI part(s) at issue in this document sold by TI to Customer on an annual basis.

**TAPE AND REEL INFORMATION**



**QUADRANT ASSIGNMENTS FOR PIN 1 ORIENTATION IN TAPE**



\*All dimensions are nominal

Device	Package Type	Package Drawing	Pins	SPQ	Reel Diameter (mm)	Reel Width W1 (mm)	A0 (mm)	B0 (mm)	K0 (mm)	P1 (mm)	W (mm)	Pin1 Quadrant
TPS76130DBVR	SOT-23	DBV	5	3000	180.0	9.0	3.15	3.2	1.4	4.0	8.0	Q3
TPS76130DBVT	SOT-23	DBV	5	250	180.0	9.0	3.15	3.2	1.4	4.0	8.0	Q3
TPS76132DBVR	SOT-23	DBV	5	3000	180.0	9.0	3.15	3.2	1.4	4.0	8.0	Q3
TPS76132DBVT	SOT-23	DBV	5	250	180.0	9.0	3.15	3.2	1.4	4.0	8.0	Q3
TPS76133DBVR	SOT-23	DBV	5	3000	180.0	9.0	3.15	3.2	1.4	4.0	8.0	Q3
TPS76133DBVT	SOT-23	DBV	5	250	180.0	9.0	3.15	3.2	1.4	4.0	8.0	Q3
TPS76138DBVR	SOT-23	DBV	5	3000	180.0	9.0	3.15	3.2	1.4	4.0	8.0	Q3
TPS76138DBVT	SOT-23	DBV	5	250	180.0	9.0	3.15	3.2	1.4	4.0	8.0	Q3
TPS76150DBVR	SOT-23	DBV	5	3000	180.0	9.0	3.15	3.2	1.4	4.0	8.0	Q3
TPS76150DBVT	SOT-23	DBV	5	250	180.0	9.0	3.15	3.2	1.4	4.0	8.0	Q3

**TAPE AND REEL BOX DIMENSIONS**



\*All dimensions are nominal

Device	Package Type	Package Drawing	Pins	SPQ	Length (mm)	Width (mm)	Height (mm)
TPS76130DBVR	SOT-23	DBV	5	3000	182.0	182.0	20.0
TPS76130DBVT	SOT-23	DBV	5	250	182.0	182.0	20.0
TPS76132DBVR	SOT-23	DBV	5	3000	182.0	182.0	20.0
TPS76132DBVT	SOT-23	DBV	5	250	182.0	182.0	20.0
TPS76133DBVR	SOT-23	DBV	5	3000	182.0	182.0	20.0
TPS76133DBVT	SOT-23	DBV	5	250	182.0	182.0	20.0
TPS76138DBVR	SOT-23	DBV	5	3000	182.0	182.0	20.0
TPS76138DBVT	SOT-23	DBV	5	250	182.0	182.0	20.0
TPS76150DBVR	SOT-23	DBV	5	3000	182.0	182.0	20.0
TPS76150DBVT	SOT-23	DBV	5	250	182.0	182.0	20.0

DBV (R-PDSO-G5)

PLASTIC SMALL-OUTLINE PACKAGE

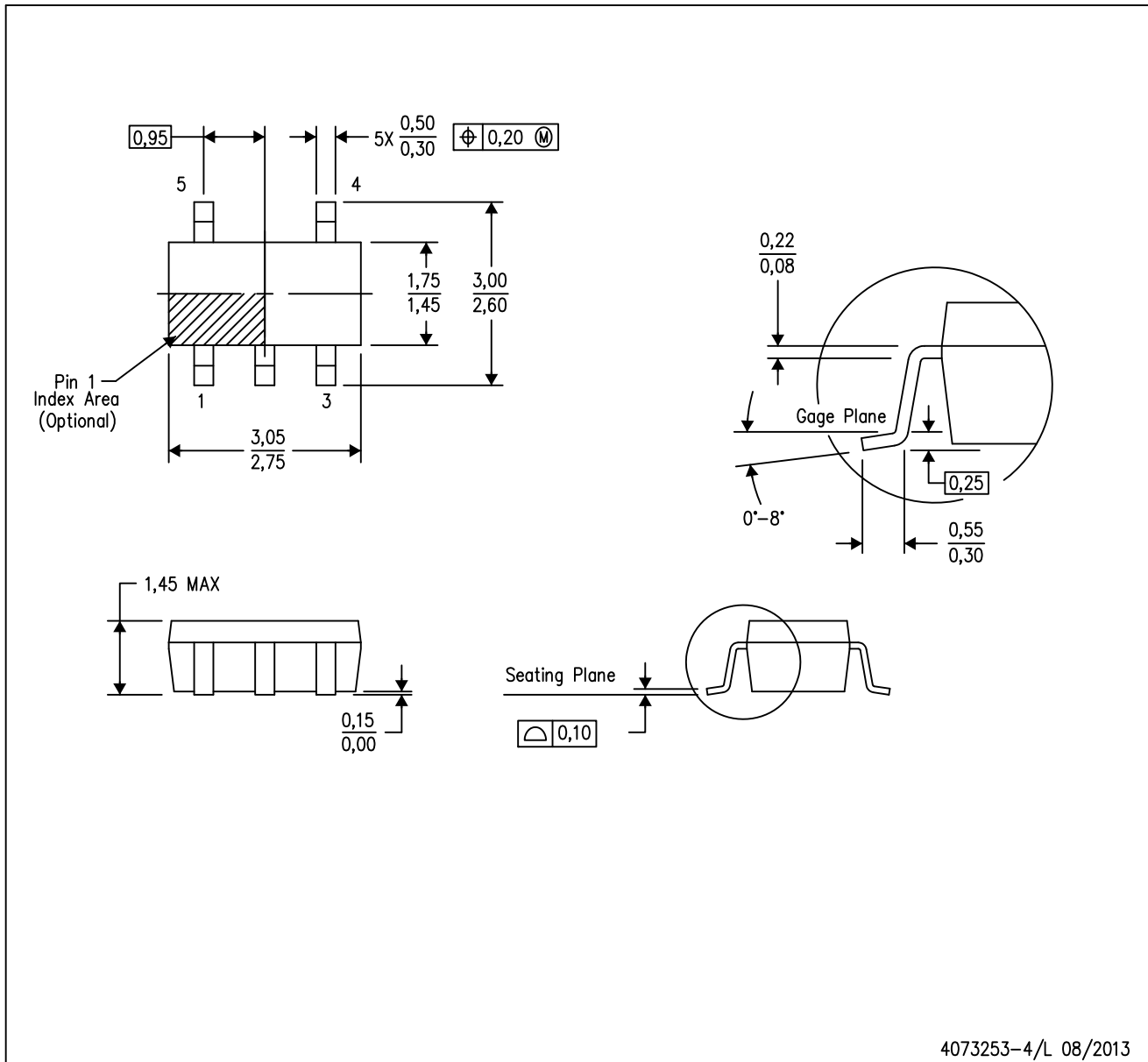

- NOTES:
- A. All linear dimensions are in millimeters.
  - B. This drawing is subject to change without notice.
  - C. Body dimensions do not include mold flash or protrusion. Mold flash and protrusion shall not exceed 0.15 per side.
  - D. Falls within JEDEC MO-178 Variation AA.

DBV (R-PDSO-G5)

PLASTIC SMALL OUTLINE



- NOTES:
- A. All linear dimensions are in millimeters.
  - B. This drawing is subject to change without notice.
  - C. Customers should place a note on the circuit board fabrication drawing not to alter the center solder mask defined pad.
  - D. Publication IPC-7351 is recommended for alternate designs.
  - E. Laser cutting apertures with trapezoidal walls and also rounding corners will offer better paste release. Customers should contact their board assembly site for stencil design recommendations. Example stencil design based on a 50% volumetric metal load solder paste. Refer to IPC-7525 for other stencil recommendations.

## IMPORTANT NOTICE

Texas Instruments Incorporated and its subsidiaries (TI) reserve the right to make corrections, enhancements, improvements and other changes to its semiconductor products and services per JESD46, latest issue, and to discontinue any product or service per JESD48, latest issue. Buyers should obtain the latest relevant information before placing orders and should verify that such information is current and complete. All semiconductor products (also referred to herein as "components") are sold subject to TI's terms and conditions of sale supplied at the time of order acknowledgment.

TI warrants performance of its components to the specifications applicable at the time of sale, in accordance with the warranty in TI's terms and conditions of sale of semiconductor products. Testing and other quality control techniques are used to the extent TI deems necessary to support this warranty. Except where mandated by applicable law, testing of all parameters of each component is not necessarily performed.

TI assumes no liability for applications assistance or the design of Buyers' products. Buyers are responsible for their products and applications using TI components. To minimize the risks associated with Buyers' products and applications, Buyers should provide adequate design and operating safeguards.

TI does not warrant or represent that any license, either express or implied, is granted under any patent right, copyright, mask work right, or other intellectual property right relating to any combination, machine, or process in which TI components or services are used. Information published by TI regarding third-party products or services does not constitute a license to use such products or services or a warranty or endorsement thereof. Use of such information may require a license from a third party under the patents or other intellectual property of the third party, or a license from TI under the patents or other intellectual property of TI.

Reproduction of significant portions of TI information in TI data books or data sheets is permissible only if reproduction is without alteration and is accompanied by all associated warranties, conditions, limitations, and notices. TI is not responsible or liable for such altered documentation. Information of third parties may be subject to additional restrictions.

Resale of TI components or services with statements different from or beyond the parameters stated by TI for that component or service voids all express and any implied warranties for the associated TI component or service and is an unfair and deceptive business practice. TI is not responsible or liable for any such statements.

Buyer acknowledges and agrees that it is solely responsible for compliance with all legal, regulatory and safety-related requirements concerning its products, and any use of TI components in its applications, notwithstanding any applications-related information or support that may be provided by TI. Buyer represents and agrees that it has all the necessary expertise to create and implement safeguards which anticipate dangerous consequences of failures, monitor failures and their consequences, lessen the likelihood of failures that might cause harm and take appropriate remedial actions. Buyer will fully indemnify TI and its representatives against any damages arising out of the use of any TI components in safety-critical applications.

In some cases, TI components may be promoted specifically to facilitate safety-related applications. With such components, TI's goal is to help enable customers to design and create their own end-product solutions that meet applicable functional safety standards and requirements. Nonetheless, such components are subject to these terms.

No TI components are authorized for use in FDA Class III (or similar life-critical medical equipment) unless authorized officers of the parties have executed a special agreement specifically governing such use.

Only those TI components which TI has specifically designated as military grade or "enhanced plastic" are designed and intended for use in military/aerospace applications or environments. Buyer acknowledges and agrees that any military or aerospace use of TI components which have **not** been so designated is solely at the Buyer's risk, and that Buyer is solely responsible for compliance with all legal and regulatory requirements in connection with such use.

TI has specifically designated certain components as meeting ISO/TS16949 requirements, mainly for automotive use. In any case of use of non-designated products, TI will not be responsible for any failure to meet ISO/TS16949.

### Products

Audio	<a href="http://www.ti.com/audio">www.ti.com/audio</a>
Amplifiers	<a href="http://amplifier.ti.com">amplifier.ti.com</a>
Data Converters	<a href="http://dataconverter.ti.com">dataconverter.ti.com</a>
DLP® Products	<a href="http://www.dlp.com">www.dlp.com</a>
DSP	<a href="http://dsp.ti.com">dsp.ti.com</a>
Clocks and Timers	<a href="http://www.ti.com/clocks">www.ti.com/clocks</a>
Interface	<a href="http://interface.ti.com">interface.ti.com</a>
Logic	<a href="http://logic.ti.com">logic.ti.com</a>
Power Mgmt	<a href="http://power.ti.com">power.ti.com</a>
Microcontrollers	<a href="http://microcontroller.ti.com">microcontroller.ti.com</a>
RFID	<a href="http://www.ti-rfid.com">www.ti-rfid.com</a>
OMAP Applications Processors	<a href="http://www.ti.com/omap">www.ti.com/omap</a>
Wireless Connectivity	<a href="http://www.ti.com/wirelessconnectivity">www.ti.com/wirelessconnectivity</a>

### Applications

Automotive and Transportation	<a href="http://www.ti.com/automotive">www.ti.com/automotive</a>
Communications and Telecom	<a href="http://www.ti.com/communications">www.ti.com/communications</a>
Computers and Peripherals	<a href="http://www.ti.com/computers">www.ti.com/computers</a>
Consumer Electronics	<a href="http://www.ti.com/consumer-apps">www.ti.com/consumer-apps</a>
Energy and Lighting	<a href="http://www.ti.com/energy">www.ti.com/energy</a>
Industrial	<a href="http://www.ti.com/industrial">www.ti.com/industrial</a>
Medical	<a href="http://www.ti.com/medical">www.ti.com/medical</a>
Security	<a href="http://www.ti.com/security">www.ti.com/security</a>
Space, Avionics and Defense	<a href="http://www.ti.com/space-avionics-defense">www.ti.com/space-avionics-defense</a>
Video and Imaging	<a href="http://www.ti.com/video">www.ti.com/video</a>

### TI E2E Community

[e2e.ti.com](http://e2e.ti.com)