

- Output Swing includes Both Supply Rails
- Low Noise . . . 12 nV/√Hz Typ at f = 1 kHz
- Low Input Bias Current . . . 1 pA Typ
- Fully Specified for Both Single-Supply and Split-Supply Operation
- Low Power . . . 500 μA Max
- Common-Mode Input Voltage Range Includes Negative Rail
- Low Input Offset Voltage  
950 μV Max at T<sub>A</sub> = 25°C (TLC2262A)
- Macromodel Included
- Performance Upgrade for the TS27M2/M4 and TLC27M2/M4
- Available in Q-Temp Automotive HighRel Automotive Applications Configuration Control/Print Support Qualification to Automotive Standards

## description

The TLC2262 and TLC2264 are dual and quadruple operational amplifiers from Texas Instruments. Both devices exhibit rail-to-rail output performance for increased dynamic range in single- or split-supply applications. The TLC226x family offers a compromise between the micropower TLC225x and the ac performance of the TLC227x. It has low supply current for battery-powered applications, while still having adequate ac performance for applications that demand it. The noise performance has been dramatically improved over previous generations of CMOS amplifiers. Figure 1 depicts the low level of noise voltage for this CMOS amplifier, which has only 200 μA (typ) of supply current per amplifier.

The TLC226x, exhibiting high input impedance and low noise, are excellent for small-signal conditioning for high-impedance sources, such as piezoelectric transducers. Because of the micro-power dissipation levels, these devices work well in hand-held monitoring and remote-sensing applications. In addition, the rail-to-rail output feature with single or split supplies makes this family a great choice when interfacing with analog-to-digital converters (ADCs). For precision applications, the TLC226xA family is available and has a maximum input offset voltage of 950 μV. This family is fully characterized at 5 V and ±5 V.

The TLC2262/4 also makes great upgrades to the TLC27M2/L4 or TS27M2/L4 in standard designs. They offer increased output dynamic range, lower noise voltage and lower input offset voltage. This enhanced feature set allows them to be used in a wider range of applications. For applications that require higher output drive and wider input voltage range, see the TLV2432 and TLV2442. If your design requires single amplifiers, please see the TLV2211/21/31 family. These devices are single rail-to-rail operational amplifiers in the SOT-23 package. Their small size and low power consumption, make them ideal for high density, battery-powered equipment.

EQUIVALENT INPUT NOISE VOLTAGE  
vs  
FREQUENCY



Figure 1



Please be aware that an important notice concerning availability, standard warranty, and use in critical applications of Texas Instruments semiconductor products and disclaimers thereto appears at the end of this data sheet.

Advanced LinCMOS is a trademark of Texas Instruments.

PRODUCTION DATA information is current as of publication date. Products conform to specifications per the terms of Texas Instruments standard warranty. Production processing does not necessarily include testing of all parameters.

 **TEXAS  
INSTRUMENTS**

POST OFFICE BOX 655303 • DALLAS, TEXAS 75265

Copyright © 2001, Texas Instruments Incorporated  
On products compliant to MIL-PRF-38535, all parameters are tested unless otherwise noted. On all other products, production processing does not necessarily include testing of all parameters.

# TLC226x, TLC226xA

## Advanced LinCMOS™ RAIL-TO-RAIL OPERATIONAL AMPLIFIERS

SLOS177D – FEBRUARY 1997 – REVISED MARCH 2001

### TLC2262 AVAILABLE OPTIONS

T <sub>A</sub>	V <sub>IO</sub> max AT 25°C	PACKAGED DEVICES					
		SMALL OUTLINE (D)	CHIP CARRIER (FK)	CERAMIC DIP (JG)	PLASTIC DIP (P)	TSSOP (PW)	CERAMIC FLATPACK (U)
0°C to 70°C	2.5 mV	TLC2262CD	—	—	TLC2262CP	TLC2262CPW	—
–40°C to 125°C	950 μV 2.5 mV	TLC2262AID TLC2262ID	— —	— —	TLC2262AIP TLC2262IP	TLC2262AIPW —	— —
–40°C to 125°C	950 μV 2.5 mV	TLC2262AQD TLC2262QD	— —	— —	— —	— —	— —
–55°C to 125°C	950 μV 2.5 mV	— —	TLC2262AMFK TLC2262MFK	TLC2262AMJG TLC2262MJG	— —	— —	TLC2262AMU TLC2262MU

The D packages are available taped and reeled. Add R suffix to device type (e.g., TLC2262CDR). The PW package is available only left-end taped and reeled. Chips are tested at 25°C.

### TLC2264 AVAILABLE OPTIONS

T <sub>A</sub>	V <sub>IO</sub> max AT 25°C	PACKAGED DEVICES					
		SMALL OUTLINE (D)	CHIP CARRIER (FK)	CERAMIC DIP (J)	PLASTIC DIP (N)	TSSOP (PW)	CERAMIC FLATPACK (W)
0°C to 70°C	2.5 mV	TLC2264CD	—	—	TLC2264CN	TLC2264CPW	—
–40°C to 125°C	950 μV 2.5 mV	TLC2264AID TLC2264ID	— —	— —	TLC2264AIN TLC2264IN	TLC2264AIPW —	— —
–40°C to 125°C	950 μV 2.5 mV	TLC2264AQD TLC2264QD	— —	— —	— —	— —	— —
–55°C to 125°C	950 μV 2.5 mV	— —	TLC2264AMFK TLC2264MFK	TLC2264AMJ TLC2264MJ	— —	— —	TLC2264AMW TLC2264MW

The D packages are available taped and reeled. Add R suffix to device type (e.g., TLC2264CDR). The PW package is available only left-end taped and reeled. Chips are tested at 25°C.



**TLC226x, TLC226xA**  
**Advanced LinCMOS™ RAIL-TO-RAIL**  
**OPERATIONAL AMPLIFIERS**

SLOS177D – FEBRUARY 1997 – REVISED MARCH 2001

**TLC2262C, TLC2262AC**  
**TLC2262I, TLC2262AI**  
**TLC2262Q, TLC2262AQ**  
**D, P, OR PW PACKAGE**  
**(TOP VIEW)**

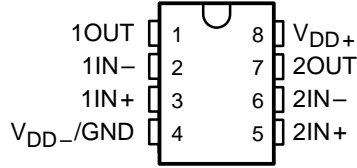

**TLC2262M, TLC2262AM ... FK PACKAGE**  
**(TOP VIEW)**

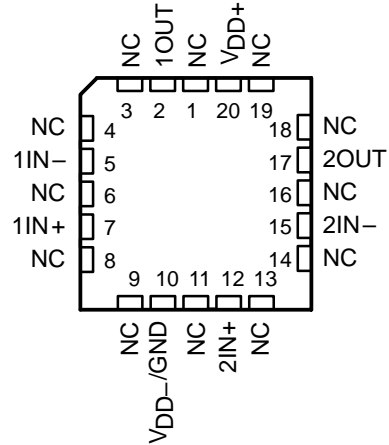

NC – No internal connection

**TLC2262M, TLC2262AM ... JG PACKAGE**  
**(TOP VIEW)**

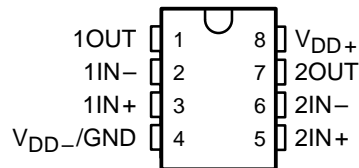

**TLC2262M, TLC2262AM ... U PACKAGE**  
**(TOP VIEW)**

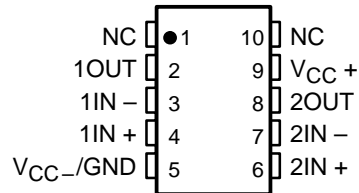

NC – No internal connection

**TLC2264C, TLC2264AC**  
**TLC2264I, TLC2264AI**  
**TLC2264Q, TLC2264AQ**  
**D, N, OR PW PACKAGE**  
**(TOP VIEW)**

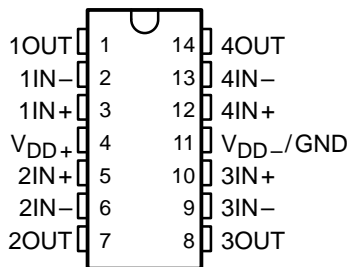

**TLC2264M, TLC2264AM ... J OR W PACKAGE**  
**(TOP VIEW)**



**TLC2264M, TLC2264AM ... FK PACKAGE**  
**(TOP VIEW)**



NC – No internal connection

**TLC226x, TLC226xA**  
**Advanced LinCMOS™ RAIL-TO-RAIL**  
**OPERATIONAL AMPLIFIERS**

SLOS177D – FEBRUARY 1997 – REVISED MARCH 2001

equivalent schematic (each amplifier)

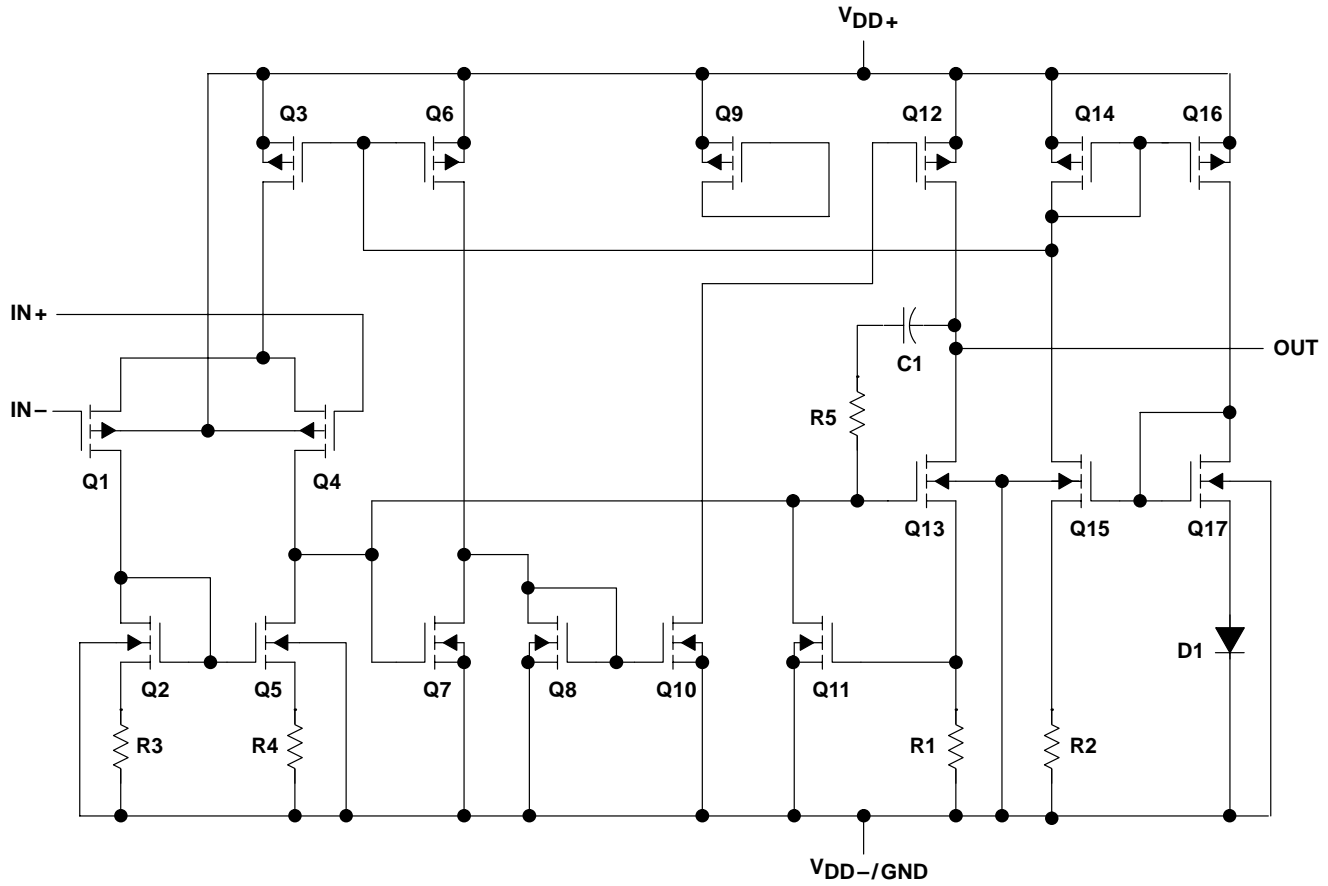

ACTUAL DEVICE COMPONENT COUNT†		
COMPONENT	TLC2262	TLC2264
Transistors	38	76
Resistors	28	56
Diodes	9	18
Capacitors	3	6

† Includes both amplifiers and all ESD, bias, and trim circuitry

**absolute maximum ratings over operating free-air temperature range (unless otherwise noted)†**

Supply voltage, $V_{DD+}$ (see Note 1)	8 V
Supply voltage, $V_{DD-}$ (see Note 1)	–8 V
Differential input voltage, $V_{ID}$ (see Note 2)	±16 V
Input voltage, $V_I$ (any input, see Note 1)	$V_{DD-} - 0.3$ V to $V_{DD+}$
Input current, $I_I$ (each input)	±5 mA
Output current, $I_O$	±50 mA
Total current into $V_{DD+}$	±50 mA
Total current out of $V_{DD-}$	±50 mA
Duration of short-circuit current at (or below) 25°C (see Note 3)	unlimited
Continuous total dissipation	See Dissipation Rating Table
Operating free-air temperature range, $T_A$ : C suffix	0°C to 70°C
I suffix	–40°C to 125°C
Q suffix	–40°C to 125°C
M suffix	–55°C to 125°C
Storage temperature range, $T_{stg}$	–65°C to 150°C
Lead temperature 1,6 mm (1/16 inch) from case for 10 seconds: D, N, P, and PW packages	260°C
J, JG, U, and W packages	300°C

† Stresses beyond those listed under “absolute maximum ratings” may cause permanent damage to the device. These are stress ratings only, and functional operation of the device at these or any other conditions beyond those indicated under “recommended operating conditions” is not implied. Exposure to absolute-maximum-rated conditions for extended periods may affect device reliability.

- NOTES: 1. All voltage values, except differential voltages, are with respect to the midpoint between  $V_{DD+}$  and  $V_{DD-}$ .  
2. Differential voltages are at  $IN+$  with respect to  $IN-$ . Excessive current flows if input is brought below  $V_{DD-} - 0.3$  V.  
3. The output may be shorted to either supply. Temperature and/or supply voltages must be limited to ensure that the maximum dissipation rating is not exceeded.

**DISSIPATION RATING TABLE**

PACKAGE	$T_A \leq 25^\circ\text{C}$ POWER RATING	DERATING FACTOR ABOVE $T_A = 25^\circ\text{C}$	$T_A = 70^\circ\text{C}$ POWER RATING	$T_A = 85^\circ\text{C}$ POWER RATING	$T_A = 125^\circ\text{C}$ POWER RATING
D–8	725 mW	5.8 mW/°C	464 mW	377 mW	145 mW
D–14	950 mW	7.6 mW/°C	608 mW	494 mW	190 mW
FK	1375 mW	11.0 mW/°C	880 mW	715 mW	275 mW
J	1375 mW	11.0 mW/°C	880 mW	715 mW	275 mW
JG	1050 mW	8.4 mW/°C	672 mW	546 mW	210 mW
N	1150 mW	9.2 mW/°C	736 mW	598 mW	230 mW
P	1000 mW	8.0 mW/°C	640 mW	520 mW	200 mW
PW–8	525 mW	4.2 mW/°C	336 mW	273 mW	105 mW
PW–14	700 mW	5.6 mW/°C	448 mW	364 mW	140 mW
U	700 mW	5.5 mW/°C	452 mW	370 mW	150 mW
W	700 mW	5.5 mW/°C	452 mW	370 mW	150 mW

**recommended operating conditions**

	C SUFFIX		I SUFFIX		Q SUFFIX		M SUFFIX		UNIT
	MIN	MAX	MIN	MAX	MIN	MAX	MIN	MAX	
Supply voltage, $V_{DD\pm}$	±2.2	±8	±2.2	±8	±2.2	±8	±2.2	±8	V
Input voltage range, $V_I$	$V_{DD-}$	$V_{DD+} - 1.5$	$V_{DD-}$	$V_{DD+} - 1.5$	$V_{DD-}$	$V_{DD+} - 1.5$	$V_{DD-}$	$V_{DD+} - 1.5$	V
Common-mode input voltage, $V_{IC}$	$V_{DD-}$	$V_{DD+} - 1.5$	$V_{DD-}$	$V_{DD+} - 1.5$	$V_{DD-}$	$V_{DD+} - 1.5$	$V_{DD-}$	$V_{DD+} - 1.5$	V
Operating free-air temperature, $T_A$	0	70	–40	125	–40	125	–55	125	°C



# TLC226x, TLC226xA Advanced LinCMOS™ RAIL-TO-RAIL OPERATIONAL AMPLIFIERS

SLOS177D – FEBRUARY 1997 – REVISED MARCH 2001

**TLC2262C electrical characteristics at specified free-air temperature,  $V_{DD} = 5\text{ V}$  (unless otherwise noted)**

PARAMETER	TEST CONDITIONS	$T_A$ †	TLC2262C			UNIT
			MIN	TYP	MAX	
$V_{IO}$ Input offset voltage	$V_{IC} = 0,$ $V_O = 0,$ $V_{DD} = \pm 2.5\text{ V},$ $R_S = 50\ \Omega$	25°C	300	2500	$\mu\text{V}$	
		Full range	3000			
$\alpha_{VIO}$ Temperature coefficient of input offset voltage		25°C to 70°C	2		$\mu\text{V}/^\circ\text{C}$	
Input offset voltage long-term drift (see Note 4)		25°C	0.003		$\mu\text{V}/\text{mo}$	
$I_{IO}$ Input offset current		25°C	0.5		$\text{pA}$	
		Full range	100			
$I_{IB}$ Input bias current	25°C	1		$\text{pA}$		
	Full range	100				
$V_{ICR}$ Common-mode input voltage range	$R_S = 50\ \Omega,$ $ V_{IO}  \leq 5\text{ mV}$	25°C	0 to 4	-0.3 to 4.2	$\text{V}$	
		Full range	0 to 3.5			
$V_{OH}$ High-level output voltage	$I_{OH} = -20\ \mu\text{A}$ $I_{OH} = -100\ \mu\text{A}$ $I_{OH} = -400\ \mu\text{A}$	25°C	4.99		$\text{V}$	
		25°C	4.85	4.94		
		Full range	4.82			
		25°C	4.70	4.85		
$V_{OL}$ Low-level output voltage	$V_{IC} = 2.5\text{ V},$ $I_{OL} = 50\ \mu\text{A}$ $I_{OL} = 500\ \mu\text{A}$ $I_{OL} = 1\text{ mA}$ $I_{OL} = 4\text{ mA}$	25°C	0.01		$\text{V}$	
		25°C	0.09	0.15		
		Full range	0.15			
		25°C	0.2	0.3		
		Full range	0.3			
		25°C	0.7	1		
		Full range	1.2			
		$A_{VD}$ Large-signal differential voltage amplification	$V_{IC} = 2.5\text{ V},$ $V_O = 1\text{ V to }4\text{ V}$	25°C		$R_L = 50\ \text{k}\Omega^\ddagger$
Full range						
25°C	$R_L = 1\ \text{M}\Omega^\ddagger$					
$r_{i(d)}$ Differential input resistance		25°C	$10^{12}$		$\Omega$	
$r_{i(c)}$ Common-mode input resistance		25°C	$10^{12}$		$\Omega$	
$c_{i(c)}$ Common-mode input capacitance	$f = 10\text{ kHz},$ P package	25°C	8		$\text{pF}$	
$z_o$ Closed-loop output impedance	$f = 100\text{ kHz},$ $A_V = 10$	25°C	240		$\Omega$	
CMRR Common-mode rejection ratio	$V_{IC} = 0\text{ to }2.7\text{ V},$ $V_O = 2.5\text{ V},$ $R_S = 50\ \Omega$	25°C	70	83	$\text{dB}$	
		Full range	70			
$k_{SVR}$ Supply-voltage rejection ratio ( $\Delta V_{DD}/\Delta V_{IO}$ )	$V_{DD} = 4.4\text{ V to }16\text{ V},$ $V_{IC} = V_{DD}/2,$ No load	25°C	80	95	$\text{dB}$	
		Full range	80			
$I_{DD}$ Supply current	$V_O = 2.5\text{ V},$ No load	25°C	400	500	$\mu\text{A}$	
		Full range	500			

† Full range is 0°C to 70°C.

‡ Referenced to 2.5 V

NOTE 4: Typical values are based on the input offset voltage shift observed through 500 hours of operating life test at  $T_A = 150^\circ\text{C}$  extrapolated to  $T_A = 25^\circ\text{C}$  using the Arrhenius equation and assuming an activation energy of 0.96 eV.



**TLC2262C operating characteristics at specified free-air temperature,  $V_{DD} = 5\text{ V}$**

PARAMETER		TEST CONDITIONS		$T_A$ †	TLC2262C			UNIT
					MIN	TYP	MAX	
SR	Slew rate at unity gain	$V_O = 1.5\text{ V to }3.5\text{ V},$ $C_L = 100\text{ pF}‡$	$R_L = 50\text{ k}\Omega‡$	25°C	0.35	0.55	V/ $\mu\text{s}$	
				Full range	0.3			
$V_n$	Equivalent input noise voltage	$f = 10\text{ Hz}$		25°C	40		nV/ $\sqrt{\text{Hz}}$	
		$f = 1\text{ kHz}$		25°C	12			
$V_{N(PP)}$	Peak-to-peak equivalent input noise voltage	$f = 0.1\text{ Hz to }1\text{ Hz}$		25°C	0.7		$\mu\text{V}$	
		$f = 0.1\text{ Hz to }10\text{ Hz}$		25°C	1.3			
$I_n$	Equivalent input noise current			25°C	0.6		fA/ $\sqrt{\text{Hz}}$	
THD + N	Total harmonic distortion plus noise	$V_O = 0.5\text{ V to }2.5\text{ V},$ $f = 20\text{ kHz},$ $R_L = 50\text{ k}\Omega‡$		25°C	$A_V = 1$	0.017%		
					$A_V = 10$	0.03%		
	Gain-bandwidth product	$f = 10\text{ kHz},$ $C_L = 100\text{ pF}‡$	$R_L = 50\text{ k}\Omega‡$	25°C	0.71		MHz	
BOM	Maximum output-swing bandwidth	$V_{O(PP)} = 2\text{ V},$ $R_L = 50\text{ k}\Omega‡$	$A_V = 1,$ $C_L = 100\text{ pF}‡$	25°C	185		kHz	
$t_s$	Settling time	$A_V = -1,$ Step = 0.5 V to 2.5 V, $R_L = 50\text{ k}\Omega‡,$ $C_L = 100\text{ pF}‡$	To 0.1%	25°C	6.4		$\mu\text{s}$	
			To 0.01%		14.1			
$\phi_m$	Phase margin at unity gain	$R_L = 50\text{ k}\Omega‡,$	$C_L = 100\text{ pF}‡$	25°C	56°			
	Gain margin			25°C	11		dB	

† Full range is 0°C to 70°C.

‡ Referenced to 2.5 V

**TLC226x, TLC226xA**  
**Advanced LinCMOS™ RAIL-TO-RAIL**  
**OPERATIONAL AMPLIFIERS**

SLOS177D – FEBRUARY 1997 – REVISED MARCH 2001

**TLC2262C electrical characteristics at specified free-air temperature,  $V_{DD\pm} = \pm 5\text{ V}$  (unless otherwise specified)**

PARAMETER	TEST CONDITIONS	T <sub>A</sub> †	TLC2262C			UNIT
			MIN	TYP	MAX	
V <sub>IO</sub> Input offset voltage	V <sub>IC</sub> = 0, V <sub>O</sub> = 0, R <sub>S</sub> = 50 Ω	25°C		300	2500	μV
		Full range			3000	
αV <sub>IO</sub> Temperature coefficient of input offset voltage		25°C to 70°C		2		μV/°C
Input offset voltage long-term drift (see Note 4)		25°C		0.003		μV/mo
I <sub>IO</sub> Input offset current		25°C		0.5		pA
		Full range			100	
I <sub>IB</sub> Input bias current		25°C		1		pA
		Full range			100	
V <sub>ICR</sub> Common-mode input voltage range		V <sub>IO</sub>   ≤ 5 mV, R <sub>S</sub> = 50 Ω	25°C	-5 to 4	-5.3 to 4.2	V
			Full range	-5 to 3.5		
V <sub>OM+</sub> Maximum positive peak output voltage	I <sub>O</sub> = -20 μA	25°C		4.99	V	
	I <sub>O</sub> = -100 μA	25°C	4.85	4.94		
		Full range	4.82			
	I <sub>O</sub> = -400 μA	25°C	4.7	4.85		
Full range		4.6				
V <sub>OM-</sub> Maximum negative peak output voltage	V <sub>IC</sub> = 0, I <sub>O</sub> = 50 μA	25°C		-4.99	V	
		25°C	-4.85	-4.91		
	V <sub>IC</sub> = 0, I <sub>O</sub> = 500 μA	Full range	-4.85			
		25°C	-4.7	-4.8		
	V <sub>IC</sub> = 0, I <sub>O</sub> = 1 mA	Full range	-4.7			
		25°C	-4	-4.3		
V <sub>IC</sub> = 0, I <sub>O</sub> = 4 mA	Full range	-3.8				
A <sub>VD</sub> Large-signal differential voltage amplification	V <sub>O</sub> = ±4 V	R <sub>L</sub> = 50 kΩ	25°C	80	200	V/mV
			Full range	55		
		R <sub>L</sub> = 1 MΩ	25°C		1000	
r <sub>i(d)</sub> Differential input resistance		25°C		10 <sup>12</sup>	Ω	
r <sub>i(c)</sub> Common-mode input resistance		25°C		10 <sup>12</sup>	Ω	
c <sub>i(c)</sub> Common-mode input capacitance	f = 10 kHz, P package	25°C		8	pF	
z <sub>o</sub> Closed-loop output impedance	f = 100 kHz, A <sub>V</sub> = 10	25°C		220	Ω	
CMRR Common-mode rejection ratio	V <sub>IC</sub> = -5 V to 2.7 V, V <sub>O</sub> = 0 V, R <sub>S</sub> = 50 Ω	25°C	75	88	dB	
		Full range	75			
k <sub>SVR</sub> Supply-voltage rejection ratio (ΔV <sub>DD±</sub> / ΔV <sub>IO</sub> )	V <sub>DD±</sub> = 2.2 V to ±8 V, V <sub>IC</sub> = 0, No load	25°C	80	95	dB	
		Full range	80			
I <sub>DD</sub> Supply current	V <sub>O</sub> = 0 V, No load	25°C	425	500	μA	
		Full range		500		

† Full range is 0°C to 70°C.

NOTE 4: Typical values are based on the input offset voltage shift observed through 500 hours of operating life test at T<sub>A</sub> = 150°C extrapolated to T<sub>A</sub> = 25°C using the Arrhenius equation and assuming an activation energy of 0.96 eV.





**TLC226x, TLC226xA**  
**Advanced LinCMOS™ RAIL-TO-RAIL**  
**OPERATIONAL AMPLIFIERS**

SLOS177D – FEBRUARY 1997 – REVISED MARCH 2001

**TLC2262C operating characteristics at specified free-air temperature,  $V_{DD\pm} = \pm 5\text{ V}$**

PARAMETER		TEST CONDITIONS		$T_A$ †	TLC2262C			UNIT
					MIN	TYP	MAX	
SR	Slew rate at unity gain	$V_O = \pm 1.9\text{ V}$ , $C_L = 100\text{ pF}$	$R_L = 50\text{ k}\Omega$	25°C	0.35	0.55	$\text{V}/\mu\text{s}$	
				Full range	0.3			
$V_n$	Equivalent input noise voltage			25°C	43		$\text{nV}/\sqrt{\text{Hz}}$	
				25°C	12			
$V_{N(PP)}$	Peak-to-peak equivalent input noise voltage			25°C	0.8		$\mu\text{V}$	
				25°C	1.3			
$I_n$	Equivalent input noise current			25°C	0.6		$\text{fA}/\sqrt{\text{Hz}}$	
THD + N	Total harmonic distortion pulse duration	$V_O = \pm 2.3\text{ V}$ , $f = 20\text{ kHz}$ , $R_L = 50\text{ k}\Omega$		25°C	$A_V = 1$	0.014%		
					$A_V = 10$	0.024%		
Gain-bandwidth product		$f = 10\text{ kHz}$ , $C_L = 100\text{ pF}$	$R_L = 50\text{ k}\Omega$	25°C	0.73		MHz	
BOM	Maximum output-swing bandwidth	$V_{O(PP)} = 4.6\text{ V}$ , $R_L = 50\text{ k}\Omega$ ,	$A_V = 1$ , $C_L = 100\text{ pF}$	25°C	85		kHz	
$t_s$	Settling time	$A_V = -1$ , Step = $-2.3\text{ V}$ to $2.3\text{ V}$ , $R_L = 50\text{ k}\Omega$ , $C_L = 100\text{ pF}$		25°C	To 0.1%	7.1		$\mu\text{s}$
					To 0.01%	16.5		
$\phi_m$	Phase margin at unity gain	$R_L = 50\text{ k}\Omega$ ,	$C_L = 100\text{ pF}$	25°C	57°			
	Gain margin			25°C	11			dB

† Full range is 0°C to 70°C.

# TLC226x, TLC226xA Advanced LinCMOS™ RAIL-TO-RAIL OPERATIONAL AMPLIFIERS

SLOS177D – FEBRUARY 1997 – REVISED MARCH 2001

**TLC2264C electrical characteristics at specified free-air temperature,  $V_{DD} = 5\text{ V}$  (unless otherwise noted)**

PARAMETER	TEST CONDITIONS	$T_A$ †	TLC2264C			UNIT
			MIN	TYP	MAX	
$V_{IO}$ Input offset voltage	$V_{IC} = 0,$ $V_O = 0,$ $V_{DD\pm} = \pm 2.5\text{ V},$ $R_S = 50\ \Omega$	25°C	300	2500	$\mu\text{V}$	
		Full range	3000			
$\alpha_{VIO}$ Temperature coefficient of input offset voltage		25°C to 70°C	2		$\mu\text{V}/^\circ\text{C}$	
Input offset voltage long-term drift (see Note 4)		25°C	0.003		$\mu\text{V}/\text{mo}$	
$I_{IO}$ Input offset current		25°C	0.5		$\text{pA}$	
		Full range	100			
$I_{IB}$ Input bias current	25°C	1		$\text{pA}$		
	Full range	100				
$V_{ICR}$ Common-mode input voltage range	$R_S = 50\ \Omega,$ $ V_{IO}  \leq 5\text{ mV}$	25°C	0 to 4	-0.3 to 4.2	$\text{V}$	
		Full range	0 to 3.5			
$V_{OH}$ High-level output voltage	$I_{OH} = -20\ \mu\text{A}$ $I_{OH} = -100\ \mu\text{A}$ $I_{OH} = -400\ \mu\text{A}$	25°C	4.99		$\text{V}$	
		25°C	4.85	4.94		
		Full range	4.82			
		25°C	4.70	4.85		
$V_{OL}$ Low-level output voltage	$V_{IC} = 2.5\text{ V},$ $I_{OL} = 50\ \mu\text{A}$ $I_{OL} = 500\ \mu\text{A}$ $I_{OL} = 1\text{ mA}$ $I_{OL} = 4\text{ mA}$	25°C	0.01		$\text{V}$	
		25°C	0.09	0.15		
		Full range	0.15			
		25°C	0.2	0.3		
$V_{OL}$ Low-level output voltage	$V_{IC} = 2.5\text{ V},$ $I_{OL} = 4\text{ mA}$	25°C	0.7	1	$\text{V}$	
		Full range	1.2			
$A_{VD}$ Large-signal differential voltage amplification	$V_{IC} = 2.5\text{ V},$ $V_O = 1\text{ V to }4\text{ V}$	25°C	80	170	$\text{V}/\text{mV}$	
		Full range	55			
		25°C	550			
$r_{i(d)}$ Differential input resistance		25°C	$10^{12}$		$\Omega$	
$r_{i(c)}$ Common-mode input resistance		25°C	$10^{12}$		$\Omega$	
$c_{i(c)}$ Common-mode input capacitance	$f = 10\text{ kHz},$ N package	25°C	8		$\text{pF}$	
$z_o$ Closed-loop output impedance	$f = 100\text{ kHz},$ $A_V = 10$	25°C	240		$\Omega$	
CMRR Common-mode rejection ratio	$V_{IC} = 0\text{ to }2.7\text{ V},$ $V_O = 2.5\text{ V},$ $R_S = 50\ \Omega$	25°C	70	83	$\text{dB}$	
		Full range	70			
kSVR Supply-voltage rejection ratio ( $\Delta V_{DD}/\Delta V_{IO}$ )	$V_{DD} = 4.4\text{ V to }16\text{ V},$ $V_{IC} = V_{DD}/2,$ No load	25°C	80	95	$\text{dB}$	
		Full range	80			
$I_{DD}$ Supply current (four amplifiers)	$V_O = 2.5\text{ V},$ No load	25°C	0.8	1	$\text{mA}$	
		Full range	1			

† Full range is 0°C to 70°C.

‡ Referenced to 2.5 V

NOTE 4. Typical values are based on the input offset voltage shift observed through 500 hours of operating life test at  $T_A = 150^\circ\text{C}$  extrapolated to  $T_A = 25^\circ\text{C}$  using the Arrhenius equation and assuming an activation energy of 0.96 eV.



**TLC226x, TLC226xA**  
**Advanced LinCMOS™ RAIL-TO-RAIL**  
**OPERATIONAL AMPLIFIERS**

SLOS177D – FEBRUARY 1997 – REVISED MARCH 2001

**TLC2264C operating characteristics at specified free-air temperature,  $V_{DD} = 5\text{ V}$**

PARAMETER		TEST CONDITIONS		$T_A$ †	TLC2264C			UNIT
					MIN	TYP	MAX	
SR	Slew rate at unity gain	$V_O = 1.4\text{ V to }2.6\text{ V}, R_L = 50\text{ k}\Omega\ddagger, C_L = 100\text{ pF}\ddagger$		25°C	0.35	0.55	V/ $\mu\text{s}$	
				Full range	0.3			
$V_n$	Equivalent input noise voltage			25°C	40		nV/ $\sqrt{\text{Hz}}$	
				25°C	12			
$V_{N(PP)}$	Peak-to-peak equivalent input noise voltage			25°C	0.7		$\mu\text{V}$	
				25°C	1.3			
$I_n$	Equivalent input noise current			25°C	0.6		fA/ $\sqrt{\text{Hz}}$	
THD + N	Total harmonic distortion plus noise	$V_O = 0.5\text{ V to }2.5\text{ V}, f = 20\text{ kHz}, R_L = 50\text{ k}\Omega\ddagger$		25°C	$A_V = 1$	0.017%		
					$A_V = 10$	0.03%		
Gain-bandwidth product		$f = 10\text{ kHz}, C_L = 100\text{ pF}\ddagger$		25°C	0.71		MHz	
BOM	Maximum output-swing bandwidth	$V_{O(PP)} = 2\text{ V}, R_L = 50\text{ k}\Omega\ddagger$		25°C	185		kHz	
$t_s$	Settling time	$A_V = -1, \text{ Step} = 0.5\text{ V to }2.5\text{ V}, R_L = 50\text{ k}\Omega\ddagger, C_L = 100\text{ pF}\ddagger$		25°C	To 0.1%	6.4		$\mu\text{s}$
					To 0.01%	14.1		
$\phi_m$	Phase margin at unity gain	$R_L = 50\text{ k}\Omega\ddagger, C_L = 100\text{ pF}\ddagger$		25°C	56°			
	Gain margin			25°C	11		dB	

† Full range is 0°C to 70°C.

‡ Referenced to 2.5 V

**TLC226x, TLC226xA**  
**Advanced LinCMOS™ RAIL-TO-RAIL**  
**OPERATIONAL AMPLIFIERS**

SLOS177D – FEBRUARY 1997 – REVISED MARCH 2001

**TLC2264C electrical characteristics at specified free-air temperature,  $V_{DD\pm} = \pm 5\text{ V}$  (unless otherwise specified)**

PARAMETER	TEST CONDITIONS	T <sub>A</sub> †	TLC2264C			UNIT
			MIN	TYP	MAX	
V <sub>IO</sub> Input offset voltage	V <sub>IC</sub> = 0, R <sub>S</sub> = 50 Ω, V <sub>O</sub> = 0,	25°C	300	2500	μV	
		Full range	3000			
α <sub>VIO</sub> Temperature coefficient of input offset voltage		25°C to 70°C	2		μV/°C	
Input offset voltage long-term drift (see Note 4)		25°C	0.003		μV/mo	
I <sub>IO</sub> Input offset current		25°C	0.5		pA	
		Full range	100			
I <sub>IB</sub> Input bias current		25°C	1		pA	
		Full range	100			
V <sub>ICR</sub> Common-mode input voltage range	V <sub>IO</sub>   ≤ 5 mV, R <sub>S</sub> = 50 Ω	25°C	-5 to 4	-5.3 to 4.2	V	
		Full range	-5 to 3.5			
V <sub>OM+</sub> Maximum positive peak output voltage	I <sub>O</sub> = -20 μA	25°C	4.99		V	
	I <sub>O</sub> = -100 μA	25°C	4.85	4.94		
		Full range	4.82			
	I <sub>O</sub> = -400 μA	25°C	4.7	4.85		
Full range		4.6				
V <sub>OM-</sub> Maximum negative peak output voltage	V <sub>IC</sub> = 0, I <sub>O</sub> = 50 μA	25°C	-4.99		V	
		25°C	-4.85	-4.91		
	V <sub>IC</sub> = 0, I <sub>O</sub> = 500 μA	Full range	-4.85			
		25°C	-4.7	-4.8		
	V <sub>IC</sub> = 0, I <sub>O</sub> = 1 mA	Full range	-4.7			
		25°C	-4	-4.3		
V <sub>IC</sub> = 0, I <sub>O</sub> = 4 mA	Full range	-3.8				
	A <sub>VD</sub> Large-signal differential voltage amplification	V <sub>O</sub> = ±4 V	R <sub>L</sub> = 50 kΩ	25°C	80	200
Full range				55		
R <sub>L</sub> = 1 MΩ			25°C	1000		
r <sub>i(d)</sub> Differential input resistance		25°C	10 <sup>12</sup>		Ω	
r <sub>i(c)</sub> Common-mode input resistance		25°C	10 <sup>12</sup>		Ω	
c <sub>i(c)</sub> Common-mode input capacitance	f = 10 kHz, N package	25°C	8		pF	
z <sub>o</sub> Closed-loop output impedance	f = 100 kHz, A <sub>V</sub> = 10	25°C	220		Ω	
CMRR Common-mode rejection ratio	V <sub>IC</sub> = -5 V to 2.7 V, V <sub>O</sub> = 0, R <sub>S</sub> = 50 Ω	25°C	75	88	dB	
		Full range	75			
k <sub>SVR</sub> Supply-voltage rejection ratio (ΔV <sub>DD±</sub> /ΔV <sub>IO</sub> )	V <sub>DD±</sub> = ±2.2 V to ±8 V, V <sub>IC</sub> = 0, No load	25°C	80	95	dB	
		Full range	80			
I <sub>DD</sub> Supply current (four amplifiers)	V <sub>O</sub> = 0, No load	25°C	0.85	1	mA	
		Full range	1			

† Full range is 0°C to 70°C.

NOTE 4: Typical values are based on the input offset voltage shift observed through 500 hours of operating life test at T<sub>A</sub> = 150°C extrapolated to T<sub>A</sub> = 25°C using the Arrhenius equation and assuming an activation energy of 0.96 eV.



**TLC2264C operating characteristics at specified free-air temperature,  $V_{DD\pm} = \pm 5\text{ V}$**

PARAMETER		TEST CONDITIONS		$T_A$ †	TLC2264C			UNIT
					MIN	TYP	MAX	
SR	Slew rate at unity gain	$V_O = \pm 1.9\text{ V}$ , $C_L = 100\text{ pF}$	$R_L = 50\text{ k}\Omega$	25°C	0.35	0.55	$\text{V}/\mu\text{s}$	
				Full range	0.3			
$V_n$	Equivalent input noise voltage			25°C	43		$\text{nV}/\sqrt{\text{Hz}}$	
				25°C	12			
$V_{N(PP)}$	Peak-to-peak equivalent input noise voltage			25°C	0.8		$\mu\text{V}$	
				25°C	1.3			
$I_n$	Equivalent input noise current			25°C	0.6		$\text{fA}/\sqrt{\text{Hz}}$	
THD + N	Total harmonic distortion plus noise	$V_O = \pm 2.3\text{ V}$ , $f = 20\text{ kHz}$ , $R_L = 50\text{ k}\Omega$		25°C	$A_V = 1$	0.014%		
					$A_V = 10$	0.024%		
	Gain-bandwidth product	$f = 10\text{ kHz}$ , $C_L = 100\text{ pF}$	$R_L = 50\text{ k}\Omega$	25°C	0.73		MHz	
$B_{OM}$	Maximum output-swing bandwidth	$V_{O(PP)} = 4.6\text{ V}$ , $R_L = 50\text{ k}\Omega$	$A_V = 1$ , $C_L = 100\text{ pF}$	25°C	70		kHz	
$t_s$	Settling time	$A_V = -1$ , Step = $-2.3\text{ V}$ to $2.3\text{ V}$ , $R_L = 50\text{ k}\Omega$ , $C_L = 100\text{ pF}$		25°C	To 0.1%	7.1		$\mu\text{s}$
					To 0.01%	16.5		
$\phi_m$	Phase margin at unity gain	$R_L = 50\text{ k}\Omega$	$C_L = 100\text{ pF}$	25°C	57°			
	Gain margin			25°C	11		dB	

† Full range is 0°C to 70°C.

# TLC226x, TLC226xA Advanced LinCMOS™ RAIL-TO-RAIL OPERATIONAL AMPLIFIERS

SLOS177D – FEBRUARY 1997 – REVISED MARCH 2001

**TLC2262I electrical characteristics at specified free-air temperature,  $V_{DD} = 5\text{ V}$  (unless otherwise noted)**

PARAMETER	TEST CONDITIONS	$T_A$ †	TLC2262I			TLC2262AI			UNIT
			MIN	TYP	MAX	MIN	TYP	MAX	
$V_{IO}$ Input offset voltage	$V_{DD\pm} = \pm 2.5\text{ V}$ , $V_O = 0$ , $V_{IC} = 0$ , $R_S = 50\ \Omega$	25°C	300	2500		300	950		$\mu\text{V}$
		Full range			3000		1500		
$\alpha_{VIO}$ Temperature coefficient of input offset voltage		25°C to 85°C		2			2		$\mu\text{V}/^\circ\text{C}$
		25°C		0.003			0.003		$\mu\text{V}/\text{mo}$
$I_{IO}$ Input offset current		25°C		0.5			0.5		pA
		85°C			150		150		pA
		Full range			800		800		pA
$I_{IB}$ Input bias current		25°C		1			1		pA
	85°C			150		150		pA	
	Full range			800		800		pA	
$V_{ICR}$ Common-mode input voltage range	$R_S = 50\ \Omega$ , $ V_{IO}  \leq 5\text{ mV}$	25°C	0 to 4	-0.3 to 4.2		0 to 4	-0.3 to 4.2		V
		Full range	0 to 3.5			0 to 3.5			
$V_{OH}$ High-level output voltage	$I_{OH} = -20\ \mu\text{A}$ $I_{OH} = -100\ \mu\text{A}$ $I_{OH} = -400\ \mu\text{A}$	25°C		4.99			4.99		V
		25°C	4.85	4.94		4.85	4.94		
		Full range	4.82			4.82			
		25°C	4.7	4.85		4.7	4.85		
$V_{OL}$ Low-level output voltage	$V_{IC} = 2.5\text{ V}$ , $I_{OL} = 50\ \mu\text{A}$ $I_{OL} = 500\ \mu\text{A}$ $I_{OL} = 4\text{ mA}$	25°C		0.01			0.01		V
		25°C	0.09	0.15		0.09	0.15		
		Full range		0.15			0.15		
		25°C	0.8	1		0.7	1		
$A_{VD}$ Large-signal differential voltage amplification	$V_{IC} = 2.5\text{ V}$ , $V_O = 1\text{ V to } 4\text{ V}$	$R_L = 50\ \text{k}\Omega$ ‡	25°C	80	100		80	170	V/mV
			Full range	50			50		
		$R_L = 1\ \text{M}\Omega$ ‡	25°C		550			550	
$r_{i(d)}$ Differential input resistance		25°C		$10^{12}$			$10^{12}$	$\Omega$	
$r_{i(c)}$ Common-mode input resistance		25°C		$10^{12}$			$10^{12}$	$\Omega$	
$C_{i(c)}$ Common-mode input capacitance	$f = 10\text{ kHz}$ , P package	25°C		8			8	pF	
$z_o$ Closed-loop output impedance	$f = 100\text{ kHz}$ , $A_V = 10$	25°C		240			240	$\Omega$	
CMRR Common-mode rejection ratio	$V_{IC} = 0\text{ to } 2.7\text{ V}$ , $V_O = 2.5\text{ V}$ , $R_S = 50\ \Omega$	25°C	70	83		70	83	dB	
		Full range	70			70			

† Full range is  $-40^\circ\text{C}$  to  $125^\circ\text{C}$ .

‡ Referenced to 2.5 V

NOTE 4: Typical values are based on the input offset voltage shift observed through 500 hours of operating life test at  $T_A = 150^\circ\text{C}$  extrapolated to  $T_A = 25^\circ\text{C}$  using the Arrhenius equation and assuming an activation energy of 0.96 eV.



**TLC2262I operating characteristics at specified free-air temperature,  $V_{DD} = 5\text{ V}$**

PARAMETER	TEST CONDITIONS	$T_A$ †	TLC2262I			TLC2262AI			UNIT	
			MIN	TYP	MAX	MIN	TYP	MAX		
$k_{SVR}$	Supply-voltage re- jection ratio ( $\Delta V_{DD}/\Delta V_{IO}$ )	$V_{DD} = 4.4\text{ V to }16\text{ V}$ , $V_{IC} = V_{DD}/2$ , No load	25°C	80	95		80	95	dB	
			Full range	80			80			
$I_{DD}$	Supply current	$V_O = 2.5\text{ V}$ , No load	25°C		400	500		400	500	$\mu\text{A}$
			Full range			500			500	
SR	Slew rate at unity gain	$V_O = 1.5\text{ V to }3.5\text{ V}$ , $R_L = 50\text{ k}\Omega$ ‡, $C_L = 100\text{ pF}$ ‡	25°C	0.35	0.55		0.35	0.55	$\text{V}/\mu\text{s}$	
			Full range	0.25			0.25			
$V_n$	Equivalent input noise voltage	$f = 10\text{ Hz}$ $f = 1\text{ kHz}$	25°C		40			40	$\text{nV}/\sqrt{\text{Hz}}$	
			25°C		12			12		
$V_{N(PP)}$	Peak-to-peak equivalent input noise voltage	$f = 0.1\text{ Hz to }1\text{ Hz}$ $f = 0.1\text{ Hz to }10\text{ Hz}$	25°C		0.7			0.7	$\mu\text{V}$	
			25°C		1.3			1.3		
$I_n$	Equivalent input noise current		25°C		0.6			0.6	$\text{fA}/\sqrt{\text{Hz}}$	
THD + N	Total harmonic distortion plus noise	$V_O = 0.5\text{ V to }2.5\text{ V}$ , $f = 20\text{ kHz}$ , $R_L = 50\text{ k}\Omega$ ‡	$A_V = 1$	25°C	0.017%		0.017%			
			$A_V = 10$		0.03%		0.03%			
	Gain-bandwidth product	$f = 50\text{ kHz}$ , $C_L = 100\text{ pF}$ ‡	$R_L = 50\text{ k}\Omega$ ‡,	25°C	0.82		0.82		MHz	
$B_{OM}$	Maximum output-swing bandwidth	$V_{O(PP)} = 2\text{ V}$ , $R_L = 50\text{ k}\Omega$ ‡,	$A_V = 1$ , $C_L = 100\text{ pF}$ ‡	25°C	185		185		kHz	
$t_s$	Settling time	$A_V = -1$ , Step = $0.5\text{ V to }2.5\text{ V}$ , $R_L = 50\text{ k}\Omega$ ‡, $C_L = 100\text{ pF}$ ‡	To 0.1%	25°C	6.4		6.4		$\mu\text{s}$	
			To 0.01%		14.1		14.1			
$\phi_m$	Phase margin at unity gain	$R_L = 50\text{ k}\Omega$ ‡,	$C_L = 100\text{ pF}$ ‡	25°C	56°		56°			
	Gain margin			25°C	11		11			dB

† Full range is  $-40^\circ\text{C to }125^\circ\text{C}$ .

‡ Referenced to 2.5 V

# TLC226x, TLC226xA Advanced LinCMOS™ RAIL-TO-RAIL OPERATIONAL AMPLIFIERS

SLOS177D – FEBRUARY 1997 – REVISED MARCH 2001

**TLC2262I electrical characteristics at specified free-air temperature,  $V_{DD\pm} = \pm 5\text{ V}$  (unless otherwise noted)**

PARAMETER	TEST CONDITIONS	$T_A$ †	TLC2262I			TLC2262AI			UNIT
			MIN	TYP	MAX	MIN	TYP	MAX	
$V_{IO}$ Input offset voltage	$V_{IC} = 0, V_O = 0$ $R_S = 50\ \Omega$	25°C	300	2500		300	950	$\mu\text{V}$	
		Full range			3000		1500		
$\alpha V_{IO}$ Temperature coefficient of input offset voltage		25°C to 85°C	2			2			$\mu\text{V}/^\circ\text{C}$
Input offset voltage long-term drift (see Note 4)		25°C	0.003			0.003			$\mu\text{V}/\text{mo}$
$I_{IO}$ Input offset current		25°C	0.5			0.5			pA
		85°C				150			pA
		Full range				800			pA
$I_{IB}$ Input bias current		25°C	1			1			pA
	85°C				150			pA	
	Full range				800			pA	
$V_{ICR}$ Common-mode input voltage range	$R_S = 50\ \Omega,  V_{IO}  \leq 5\ \text{mV}$	25°C	-5 to 4	-5.3 to 4.2		-5 to 4	-5.3 to 4.2	V	
		Full range	-5 to 3.5			-5 to 3.5			
$V_{OM+}$ Maximum positive peak output voltage	$I_O = -20\ \mu\text{A}$ $I_O = -100\ \mu\text{A}$ $I_O = -400\ \mu\text{A}$	25°C	4.99		4.99		V		
		25°C	4.85	4.94	4.85	4.94			
		Full range	4.82		4.82				
		25°C	4.7	4.85	4.7	4.85			
$V_{OM-}$ Maximum negative peak output voltage	$V_{IC} = 0, I_O = 50\ \mu\text{A}$ $V_{IC} = 0, I_O = 500\ \mu\text{A}$ $V_{IC} = 0, I_O = 4\ \text{mA}$	25°C	-4.99		-4.99		V		
		25°C	-4.85	-4.91	-4.85	-4.91			
		Full range	-4.85		-4.85				
		25°C	-4	-4.3	-4	-4.3			
$A_{VD}$ Large-signal differential voltage amplification	$V_O = \pm 4\ \text{V}$	$R_L = 50\ \text{k}\Omega$	25°C	80	200	80	200	V/mV	
			Full range	50		50			
		$R_L = 1\ \text{M}\Omega$	25°C	1000		1000			
$r_{i(d)}$ Differential input resistance		25°C	1012			1012		$\Omega$	
$r_{i(c)}$ Common-mode input resistance		25°C	1012			1012		$\Omega$	
$C_{i(c)}$ Common-mode input capacitance	$f = 10\ \text{kHz}, \text{ P package}$	25°C	8			8		pF	
$z_o$ Closed-loop output impedance	$f = 100\ \text{kHz}, A_V = 10$	25°C	220			220		$\Omega$	
CMRR Common-mode rejection ratio	$V_{IC} = -5\ \text{V to } 2.7\ \text{V}, V_O = 0, R_S = 50\ \Omega$	25°C	75	88	75	88	dB		
		Full range	75		75				
$k_{SVR}$ Supply-voltage rejection ratio ( $\Delta V_{DD\pm} / \Delta V_{IO}$ )	$V_{DD} = 4.4\ \text{V to } 16\ \text{V}, V_{IC} = V_{DD}/2, \text{ No load}$	25°C	80	95	80	95	dB		
		Full range	80		80				

† Full range is -40°C to 125°C.

NOTE 4: Typical values are based on the input offset voltage shift observed through 500 hours of operating life test at  $T_A = 150^\circ\text{C}$  extrapolated to  $T_A = 25^\circ\text{C}$  using the Arrhenius equation and assuming an activation energy of 0.96 eV.





**TLC2262I operating characteristics at specified free-air temperature,  $V_{DD\pm} = \pm 5\text{ V}$**

PARAMETER	TEST CONDITIONS	$T_A$ †	TLC2262I			TLC2262AI			UNIT
			MIN	TYP	MAX	MIN	TYP	MAX	
$I_{DD}$ Supply Current	$V_O = 2.5\text{ V}$ , No load	25°C	425	500		425	500		
		Full range		500			500		
SR Slew rate at unity gain	$V_O = \pm 1.9\text{ V}$ , $R_L = 50\text{ k}\Omega$ , $C_L = 100\text{ pF}$	25°C	0.35	0.55		0.35	0.55	V/ $\mu\text{s}$	
		Full range	0.25			0.25			
$V_n$ Equivalent input noise voltage	$f = 10\text{ Hz}$ $f = 1\text{ kHz}$	25°C		43			43	nV/ $\sqrt{\text{Hz}}$	
		25°C		12			12		
$V_{N(PP)}$ Peak-to-peak equivalent input noise voltage	$f = 0.1\text{ Hz to }1\text{ Hz}$ $f = 0.1\text{ Hz to }10\text{ Hz}$	25°C		0.8			0.8	$\mu\text{V}$	
		25°C		1.3			1.3		
$I_n$ Equivalent input noise current		25°C		0.6			0.6	fA/ $\sqrt{\text{Hz}}$	
THD + N Total harmonic distortion plus noise	$V_O = \pm 2.3\text{ V}$ , $R_L = 50\text{ k}\Omega$ , $f = 20\text{ kHz}$	25°C		$A_V = 1$		0.014%		0.014%	
				$A_V = 10$		0.024%		0.024%	
Gain-bandwidth product	$f = 10\text{ kHz}$ , $C_L = 100\text{ pF}$	25°C			$R_L = 50\text{ k}\Omega$	0.73		0.73	MHz
$B_{OM}$ Maximum output-swing bandwidth	$V_{O(PP)} = 4.6\text{ V}$ , $R_L = 50\text{ k}\Omega$	25°C			$A_V = 1$ , $C_L = 100\text{ pF}$	85		85	kHz
$t_s$ Settling time	$A_V = -1$ , Step = $-2.3\text{ V to }2.3\text{ V}$ , $R_L = 50\text{ k}\Omega$ , $C_L = 100\text{ pF}$	25°C		To 0.1%		7.1		7.1	$\mu\text{s}$
				To 0.01%		16.5		16.5	
$\phi_m$ Phase margin at unity gain	$R_L = 50\text{ k}\Omega$ , $C_L = 100\text{ pF}$	25°C				57°		57°	
		25°C				11		11	
Gain margin		25°C							dB

† Full range is  $-40^\circ\text{C}$  to  $125^\circ\text{C}$ .

# TLC226x, TLC226xA Advanced LinCMOS™ RAIL-TO-RAIL OPERATIONAL AMPLIFIERS

SLOS177D – FEBRUARY 1997 – REVISED MARCH 2001

**TLC2264I electrical characteristics at specified free-air temperature,  $V_{DD} = 5\text{ V}$  (unless otherwise noted)**

PARAMETER	TEST CONDITIONS	$T_A$ †	TLC2264I			TLC2264AI			UNIT	
			MIN	TYP	MAX	MIN	TYP	MAX		
$V_{IO}$ Input offset voltage	$V_{DD} = \pm 2.5\text{ V}$ , $V_O = 0$ , $V_{IC} = 0$ , $R_S = 50\ \Omega$	25°C	300	2500		300	950	$\mu\text{V}$		
		Full range		3000		1500				
$\alpha V_{IO}$ Temperature coefficient of input offset voltage		25°C to 125°C	2			2		$\mu\text{V}/^\circ\text{C}$		
Input offset voltage long-term drift (see Note 4)		25°C	0.003			0.003		$\mu\text{V}/\text{mo}$		
$I_{IO}$ Input offset current		25°C	0.5			0.5		$\text{pA}$		
		85°C		150		150				
		Full range		800		800				
$I_{IB}$ Input bias current		25°C	1			1		$\text{pA}$		
		85°C		150		150				
		Full range		800		800				
$V_{ICR}$ Common-mode input voltage range	$R_S = 50\ \Omega$ , $ V_{IO}  \leq 5\text{ mV}$	25°C	0 to 4	-0.3 to 4.2		0 to 4	-0.3 to 4.2	V		
		Full range	0 to 3.5			0 to 3.5				
$V_{OH}$ High-level output voltage	$I_{OH} = -20\ \mu\text{A}$	25°C	4.99			4.99		V		
	$I_{OH} = -100\ \mu\text{A}$	25°C	4.85	4.94		4.85	4.94			
		Full range	4.82			4.82				
	$I_{OH} = -400\ \mu\text{A}$	25°C	4.7	4.85		4.7	4.85			
Full range		4.5			4.5					
$V_{OL}$ Low-level output voltage	$V_{IC} = 2.5\text{ V}$ , $I_{OL} = 50\ \mu\text{A}$	25°C	0.01			0.01		V		
		Full range	0.09	0.15		0.09	0.15			
	$V_{IC} = 2.5\text{ V}$ , $I_{OL} = 500\ \mu\text{A}$	25°C	0.09	0.15		0.09	0.15			
		Full range		0.15			0.15			
$V_{OL}$ Low-level output voltage	$V_{IC} = 2.5\text{ V}$ , $I_{OL} = 4\text{ mA}$	25°C	0.8	1		0.7	1	V		
		Full range		1.2			1.2			
	$V_{IC} = 2.5\text{ V}$ , $V_O = 1\text{ V to }4\text{ V}$	$R_L = 50\text{ k}\Omega$ ‡	25°C	80	100		80		170	V/mV
		Full range	50			50				
$R_L = 1\text{ M}\Omega$ ‡	25°C	550			550					
$r_{i(d)}$ Differential input resistance		25°C	$10^{12}$			$10^{12}$		$\Omega$		
$r_{i(c)}$ Common-mode input resistance		25°C	$10^{12}$			$10^{12}$		$\Omega$		
$C_{i(c)}$ Common-mode input capacitance	$f = 10\text{ kHz}$ , N package	25°C	8			8		pF		
$z_o$ Closed-loop output impedance	$f = 100\text{ kHz}$ , $A_V = 10$	25°C	240			240		$\Omega$		
CMRR Common-mode rejection ratio	$V_{IC} = 0\text{ to }2.7\text{ V}$ , $V_O = 2.5\text{ V}$ , $R_S = 50\ \Omega$	25°C	70	83		70	83	dB		
		Full range	70			70				
$k_{SVR}$ Supply-voltage rejection ratio ( $\Delta V_{DD}/\Delta V_{IO}$ )	$V_{DD} = 4.4\text{ V to }16\text{ V}$ , $V_{IC} = V_{DD}/2$ , No load	25°C	80	95		80	95	dB		
		Full range	80			80				

† Full range is  $-40^\circ\text{C}$  to  $125^\circ\text{C}$ .

‡ Referenced to 2.5 V

NOTE 4: Typical values are based on the input offset voltage shift observed through 500 hours of operating life test at  $T_A = 150^\circ\text{C}$  extrapolated to  $T_A = 25^\circ\text{C}$  using the Arrhenius equation and assuming an activation energy of 0.96 eV.



**TLC2264I operating characteristics at specified free-air temperature,  $V_{DD} = 5\text{ V}$**

PARAMETER	TEST CONDITIONS	$T_A$ †	TLC2264I			TLC2264AI			UNIT
			MIN	TYP	MAX	MIN	TYP	MAX	
$I_{DD}$ Supply current (four amplifiers)	$V_O = 2.5\text{ V}$ , No load	25°C	0.8	1		0.8	1	V/ $\mu\text{s}$	
		Full range			1		1		
SR Slew rate at unity gain	$V_O = 1.4\text{ V to } 2.6\text{ V}$ , $R_L = 50\text{ k}\Omega$ ‡, $C_L = 100\text{ pF}$ ‡	25°C	0.35	0.55		0.35	0.55	V/ $\mu\text{s}$	
		Full range	0.25			0.25			
$V_n$ Equivalent input noise voltage	$f = 10\text{ Hz}$	25°C		40			40	nV/ $\sqrt{\text{Hz}}$	
	$f = 1\text{ kHz}$	25°C		12			12		
$V_{N(PP)}$ Peak-to-peak equivalent input noise voltage	$f = 0.1\text{ Hz to } 1\text{ Hz}$	25°C		0.7			0.7	$\mu\text{V}$	
	$f = 0.1\text{ Hz to } 10\text{ Hz}$	25°C		1.3			1.3		
$I_n$ Equivalent input noise current		25°C		0.6			0.6	fA/ $\sqrt{\text{Hz}}$	
THD + N Total harmonic distortion plus noise	$V_O = 0.5\text{ V to } 2.5\text{ V}$ , $f = 20\text{ kHz}$ , $R_L = 50\text{ k}\Omega$ ‡	$A_V = 1$	25°C			0.017%	0.017%		
		$A_V = 10$	25°C			0.03%	0.03%		
Gain-bandwidth product	$f = 50\text{ kHz}$ , $C_L = 100\text{ pF}$ ‡	$R_L = 50\text{ k}\Omega$ ‡	25°C	0.71			0.71	MHz	
$B_{OM}$ Maximum output-swing bandwidth	$V_{O(PP)} = 2\text{ V}$ , $R_L = 50\text{ k}\Omega$ ‡	$A_V = 1$ , $C_L = 100\text{ pF}$ ‡	25°C	185			185	kHz	
$t_s$ Settling time	$A_V = -1$ , Step = $0.5\text{ V to } 2.5\text{ V}$ , $R_L = 50\text{ k}\Omega$ ‡, $C_L = 100\text{ pF}$ ‡	To 0.1%	25°C			6.4	6.4		$\mu\text{s}$
		To 0.01%	25°C			14.1	14.1		
$\phi_m$ Phase margin at unity gain	$R_L = 50\text{ k}\Omega$ ‡, $C_L = 100\text{ pF}$ ‡	25°C		56°			56°		
		25°C		11			11		
Gain margin		25°C		11			11	dB	

† Full range is  $-40^\circ\text{C to } 125^\circ\text{C}$ .

‡ Referenced to  $2.5\text{ V}$

# TLC226x, TLC226xA Advanced LinCMOS™ RAIL-TO-RAIL OPERATIONAL AMPLIFIERS

SLOS177D – FEBRUARY 1997 – REVISED MARCH 2001

**TLC2264I electrical characteristics at specified free-air temperature,  $V_{DD\pm} = \pm 5\text{ V}$  (unless otherwise noted)**

PARAMETER	TEST CONDITIONS	$T_A$ †	TLC2264I			TLC2264AI			UNIT
			MIN	TYP	MAX	MIN	TYP	MAX	
$V_{IO}$ Input offset voltage		25°C		300	2500		300	950	$\mu\text{V}$
		Full range			3000			1500	
$\alpha V_{IO}$ Temperature coefficient of input offset voltage		25°C to 125°C		2			2	$\mu\text{V}/^\circ\text{C}$	
Input offset voltage long-term drift (see Note 4)	$V_{IC} = 0, V_O = 0, R_S = 50\ \Omega$	25°C		0.003			0.003	$\mu\text{V}/\text{mo}$	
$I_{IO}$ Input offset current		25°C		0.5			0.5	pA	
	85°C			150		150			
	Full range			800		800			
$I_{IB}$ Input bias current		25°C		1			1	pA	
		85°C			150		150	pA	
		Full range			800		800	pA	
$V_{ICR}$ Common-mode input voltage range	$R_S = 50\ \Omega,  V_{IO}  \leq 5\ \text{mV}$	25°C	-5 to 4	-5.3 to 4.2		-5 to 4	-5.3 to 4.2	V	
		Full range	-5 to 3.5			-5 to 3.5			
$V_{OM+}$ Maximum positive peak output voltage	$I_O = -20\ \mu\text{A}$	25°C		4.99			4.99	V	
		25°C		4.85	4.94		4.85		4.94
		Full range		4.82			4.82		
		25°C		4.7	4.85		4.7		4.85
$V_{OM-}$ Maximum negative peak output voltage	$I_O = -400\ \mu\text{A}$	25°C		-4.99			-4.99	V	
		25°C		-4.85	-4.91		-4.85		-4.91
		Full range		-4.85			-4.85		
		25°C		-4	-4.3		-4		-4.3
$V_{IC} = 0, I_O = 4\ \text{mA}$	$I_O = 50\ \mu\text{A}$	25°C		-4.99			-4.99	V	
		25°C		-4.85	-4.91		-4.85		-4.91
		Full range		-4.85			-4.85		
		25°C		-4	-4.3		-4		-4.3
$V_{IC} = 0, I_O = 4\ \text{mA}$	$I_O = 500\ \mu\text{A}$	25°C		-4	-4.3		-4	-4.3	V
		Full range		-3.8			-3.8		
		25°C		-4	-4.3		-4	-4.3	
$A_{VD}$ Large-signal differential voltage amplification	$V_O = \pm 4\ \text{V}$	$R_L = 50\ \text{k}\Omega$	25°C	80	200		80	200	V/mV
			Full range		50			50	
		$R_L = 1\ \text{M}\Omega$	25°C		1000			1000	
$r_{i(d)}$ Differential input resistance		25°C		$10^{12}$			$10^{12}$	$\Omega$	
$r_{i(c)}$ Common-mode input resistance		25°C		$10^{12}$			$10^{12}$	$\Omega$	
$C_{i(c)}$ Common-mode input capacitance	$f = 10\ \text{kHz}, \text{N package}$	25°C		8			8	pF	
$Z_o$ Closed-loop output impedance	$f = 100\ \text{kHz}, A_V = 10$	25°C		220			220	$\Omega$	
CMRR Common-mode rejection ratio	$V_{IC} = -5\ \text{V to } 2.7\ \text{V}, V_O = 0, R_S = 50\ \Omega$	25°C		75	88		75	88	dB
		Full range		75			75		
$k_{SVR}$ Supply-voltage rejection ratio ( $\Delta V_{DD\pm}/\Delta V_{IO}$ )	$V_{DD\pm} = \pm 2.2\ \text{V to } \pm 8\ \text{V}, V_{IC} = V_{DD}/2, \text{No load}$	25°C		80	95		80	95	dB
		Full range		80			80		

† Full range is -40°C to 125°C.

NOTE 4: Typical values are based on the input offset voltage shift observed through 500 hours of operating life test at  $T_A = 150^\circ\text{C}$  extrapolated to  $T_A = 25^\circ\text{C}$  using the Arrhenius equation and assuming an activation energy of 0.96 eV.



**TLC2264I operating characteristics at specified free-air temperature,  $V_{DD\pm} = \pm 5\text{ V}$**

PARAMETER	TEST CONDITIONS	$T_A$ †	TLC2264I			TLC2264AI			UNIT
			MIN	TYP	MAX	MIN	TYP	MAX	
$I_{DD}$ Supply current (four amplifiers)	$V_O = 0$ , No load	25°C	0.85	1		0.85	1		
		Full range			1		1		
SR Slew rate at unity gain	$V_O = \pm 1.9\text{ V}$ , $C_L = 100\text{ pF}$ , $R_L = 50\text{ k}\Omega$	25°C	0.35	0.55		0.35	0.55	V/ $\mu\text{s}$	
		Full range	0.25			0.25			
$V_n$ Equivalent input noise voltage	$f = 10\text{ Hz}$	25°C		43			43	nV/ $\sqrt{\text{Hz}}$	
	$f = 1\text{ kHz}$	25°C		12			12		
$V_{N(PP)}$ Peak-to-peak equivalent input noise voltage	$f = 0.1\text{ Hz to }1\text{ Hz}$	25°C		0.8			0.8	$\mu\text{V}$	
	$f = 0.1\text{ Hz to }10\text{ Hz}$	25°C		1.3			1.3		
$I_n$ Equivalent input noise current		25°C		0.6			0.6	fA/ $\sqrt{\text{Hz}}$	
THD + N Total harmonic distortion plus noise	$V_O = \pm 2.3\text{ V}$ , $R_L = 50\text{ k}\Omega$ , $f = 20\text{ kHz}$	$A_V = 1$	25°C			0.014%		0.014%	
		$A_V = 10$	25°C			0.024%		0.024%	
Gain-bandwidth product	$f = 10\text{ kHz}$ , $C_L = 100\text{ pF}$ , $R_L = 50\text{ k}\Omega$	25°C		0.73			0.73	MHz	
$B_{OM}$ Maximum output-swing bandwidth	$V_{O(PP)} = 4.6\text{ V}$ , $R_L = 50\text{ k}\Omega$ , $A_V = 1$ , $C_L = 100\text{ pF}$	25°C		70			70	kHz	
$t_s$ Settling time	$A_V = -1$ , Step = $-2.3\text{ V to }2.3\text{ V}$ , $R_L = 50\text{ k}\Omega$ , $C_L = 100\text{ pF}$	To 0.1%	25°C			7.1		7.1	$\mu\text{s}$
		To 0.01%	25°C			16.5		16.5	
$\phi_m$ Phase margin at unity gain	$R_L = 50\text{ k}\Omega$ , $C_L = 100\text{ pF}$	25°C		57°			57°		
		Gain margin	25°C		11			11	dB

† Full range is  $-40^\circ\text{C}$  to  $125^\circ\text{C}$ .

# TLC226x, TLC226xA Advanced LinCMOS™ RAIL-TO-RAIL OPERATIONAL AMPLIFIERS

SLOS177D – FEBRUARY 1997 – REVISED MARCH 2001

**TLC2262Q/M electrical characteristics at specified free-air temperature,  $V_{DD} = 5\text{ V}$  (unless otherwise noted)**

PARAMETER	TEST CONDITIONS	$T_A$ †	TLC2262Q, TLC2262M			TLC2262AQ, TLC2262AM			UNIT
			MIN	TYP	MAX	MIN	TYP	MAX	
$V_{IO}$ Input offset voltage	$V_{DD\pm} = \pm 2.5\text{ V}$ , $V_O = 0$ , $V_{IC} = 0$ , $R_S = 50\ \Omega$	25°C	300	2500		300	950	$\mu\text{V}$	
		Full range			3000		1500		
$\alpha_{VIO}$ Temperature coefficient of input offset voltage		Full range		5			5	$\mu\text{V}/^\circ\text{C}$	
Input offset voltage long-term drift (see Note 4)		25°C		0.003			0.003	$\mu\text{V}/\text{mo}$	
$I_{IO}$ Input offset current		25°C		0.5			0.5	$\text{pA}$	
		125°C			800		800		
$I_{IB}$ Input bias current	25°C		1			1	$\text{pA}$		
	125°C			800		800			
$V_{ICR}$ Common-mode input voltage range	$R_S = 50\ \Omega$ , $ V_{IO}  \leq 5\text{ mV}$	25°C	0 to 4	-0.3 to 4.2		0 to 4	-0.3 to 4.2	V	
		Full range	0 to 3.5			0 to 3.5			
$V_{OH}$ High-level output voltage	$I_{OH} = -20\ \mu\text{A}$	25°C		4.99			4.99	V	
		25°C	4.85	4.94		4.85	4.94		
		Full range	4.82			4.82			
		25°C	4.7	4.85		4.7	4.85		
$V_{OL}$ Low-level output voltage	$V_{IC} = 2.5\text{ V}$ , $I_{OL} = 50\ \mu\text{A}$	25°C		0.01			0.01	V	
		25°C	0.09	0.15		0.09	0.15		
		Full range		0.15			0.15		
		25°C	0.8	1		0.7	1		
$V_{OL}$ Low-level output voltage	$V_{IC} = 2.5\text{ V}$ , $I_{OL} = 500\ \mu\text{A}$	25°C		0.01			0.01	V	
		25°C	0.09	0.15		0.09	0.15		
		Full range		0.15			0.15		
		25°C	0.8	1		0.7	1		
$V_{OL}$ Low-level output voltage	$V_{IC} = 2.5\text{ V}$ , $I_{OL} = 4\text{ mA}$	25°C		0.01			0.01	V	
		25°C	0.09	0.15		0.09	0.15		
		Full range		0.15			0.15		
		25°C	0.8	1		0.7	1		
$A_{VD}$ Large-signal differential voltage amplification	$V_{IC} = 2.5\text{ V}$ , $V_O = 1\text{ V to }4\text{ V}$	$R_L = 50\text{ k}\Omega$ ‡	25°C	80	100		80	170	V/mV
			Full range	50			50		
		$R_L = 1\text{ M}\Omega$ ‡	25°C		550			550	
$r_{i(d)}$ Differential input resistance		25°C		$10^{12}$			$10^{12}$	$\Omega$	
$r_{i(c)}$ Common-mode input resistance		25°C		$10^{12}$			$10^{12}$	$\Omega$	
$C_{i(c)}$ Common-mode input capacitance	$f = 10\text{ kHz}$ , P package	25°C		8			8	pF	
$Z_o$ Closed-loop output impedance	$f = 100\text{ kHz}$ , $A_V = 10$	25°C		240			240	$\Omega$	
CMRR Common-mode rejection ratio	$V_{IC} = 0\text{ to }2.7\text{ V}$ , $V_O = 2.5\text{ V}$ , $R_S = 50\ \Omega$	25°C	70	83		70	83	dB	
		Full range	70			70			
$k_{SVR}$ Supply-voltage rejection ratio ( $\Delta V_{DD}/\Delta V_{IO}$ )	$V_{DD} = 4.4\text{ V to }16\text{ V}$ , $V_{IC} = V_{DD}/2$ , No load	25°C	80	95		80	95	dB	
		Full range	80			80			
$I_{DD}$ Supply current	$V_O = 2.5\text{ V}$ , No load	25°C		400	500		400	500	$\mu\text{A}$
		Full range			500			500	

† Full range is  $-40^\circ\text{C}$  to  $125^\circ\text{C}$  for Q suffix,  $-55^\circ\text{C}$  to  $125^\circ\text{C}$  for M suffix.

‡ Referenced to 2.5 V

NOTE 4: Typical values are based on the input offset voltage shift observed through 500 hours of operating life test at  $T_A = 150^\circ\text{C}$  extrapolated to  $T_A = 25^\circ\text{C}$  using the Arrhenius equation and assuming an activation energy of 0.96 eV.



**TLC2262Q/M operating characteristics at specified free-air temperature,  $V_{DD} = 5\text{ V}$**

PARAMETER	TEST CONDITIONS	$T_A$ †	TLC2262Q, TLC2262M			TLC2262AQ, TLC2262AM			UNIT
			MIN	TYP	MAX	MIN	TYP	MAX	
SR	Slew rate at unity gain $V_O = 0.5\text{ V to }3.5\text{ V}, R_L = 50\text{ k}\Omega\ddagger, C_L = 100\text{ pF}\ddagger$	25°C	0.35	0.55		0.35	0.55		V/ $\mu$ s
		Full range	0.25			0.25			
$V_n$	Equivalent input noise voltage $f = 10\text{ Hz}$ $f = 1\text{ kHz}$	25°C	40			40			nV/ $\sqrt{\text{Hz}}$
		25°C	12			12			
$V_{N(PP)}$	Peak-to-peak equivalent input noise voltage $f = 0.1\text{ Hz to }1\text{ Hz}$ $f = 0.1\text{ Hz to }10\text{ Hz}$	25°C	0.7			0.7			$\mu$ V
		25°C	1.3			1.3			
$I_n$	Equivalent input noise current	25°C	0.6			0.6			fA/ $\sqrt{\text{Hz}}$
THD + N	Total harmonic distortion plus noise $V_O = 0.5\text{ V to }2.5\text{ V}, f = 20\text{ kHz}, R_L = 50\text{ k}\Omega\ddagger$	25°C	$A_V = 1$			0.017%			
			$A_V = 10$			0.03%			
	Gain-bandwidth product $f = 50\text{ kHz}, C_L = 100\text{ pF}\ddagger$	25°C	0.82			0.82			MHz
$B_{OM}$	Maximum output-swing bandwidth $V_{O(PP)} = 2\text{ V}, R_L = 50\text{ k}\Omega\ddagger, C_L = 100\text{ pF}\ddagger$	25°C	185			185			kHz
$t_s$	Settling time $A_V = -1, \text{ Step} = 0.5\text{ V to }2.5\text{ V}, R_L = 50\text{ k}\Omega\ddagger, C_L = 100\text{ pF}\ddagger$	25°C	To 0.1%			6.4			$\mu$ s
			To 0.01%			14.1			
$\phi_m$	Phase margin at unity gain $R_L = 50\text{ k}\Omega\ddagger, C_L = 100\text{ pF}\ddagger$	25°C	56°			56°			
		25°C	11			11			
	Gain margin	25°C	11			11			dB

† Full range is  $-40^\circ\text{C}$  to  $125^\circ\text{C}$  for Q suffix,  $-55^\circ\text{C}$  to  $125^\circ\text{C}$  for M suffix.

‡ Referenced to 2.5 V

**TLC226x, TLC226xA**  
**Advanced LinCMOS™ RAIL-TO-RAIL**  
**OPERATIONAL AMPLIFIERS**

SLOS177D – FEBRUARY 1997 – REVISED MARCH 2001

**TLC2262Q/M electrical characteristics at specified free-air temperature,  $V_{DD\pm} = \pm 5\text{ V}$  (unless otherwise noted)**

PARAMETER	TEST CONDITIONS	T <sub>A</sub> †	TLC2262Q, TLC2262M			TLC2262AQ, TLC2262AM			UNIT
			MIN	TYP	MAX	MIN	TYP	MAX	
V <sub>IO</sub> Input offset voltage	V <sub>IC</sub> = 0, V <sub>O</sub> = 0, R <sub>S</sub> = 50 Ω	25°C	300	2500		300	950	μV	
		Full range		3000		1500			
αV <sub>IO</sub> Temperature coefficient of input offset voltage		Full range	5		5		μV/°C		
Input offset voltage long-term drift (see Note 4)		25°C	0.003		0.003		μV/mo		
I <sub>IO</sub> Input offset current		25°C	0.5		0.5		pA		
		125°C		800		800			
I <sub>IB</sub> Input bias current	25°C	1		1		pA			
	125°C		800		800				
V <sub>ICR</sub> Common-mode input voltage range	R <sub>S</sub> = 50 Ω,  V <sub>IO</sub>   ≤ 5 mV	25°C	-5 to 4	-5.3 to 4		-5 to 4	-5.3 to 4.2	V	
		Full range	-5 to 3.5		-5 to 3.5				
V <sub>OM+</sub> Maximum positive peak output voltage	I <sub>O</sub> = -20 μA	25°C	4.99		4.99		V		
	I <sub>O</sub> = -100 μA	25°C	4.85	4.94	4.85	4.94			
		Full range	4.82		4.82				
	I <sub>O</sub> = -400 μA	25°C	4.7	4.85	4.7	4.85			
Full range		4.5		4.5					
V <sub>OM-</sub> Maximum negative peak output voltage	V <sub>IC</sub> = 0, I <sub>O</sub> = 50 μA	25°C	-4.99		-4.99		V		
		25°C	-4.85	-4.91	-4.85	-4.91			
	Full range	-4.85		-4.85					
	V <sub>IC</sub> = 0, I <sub>O</sub> = 4 mA	25°C	-4	-4.3	-4	-4.3			
Full range		-3.8		-3.8					
A <sub>VD</sub> Large-signal differential voltage amplification	V <sub>O</sub> = ±4 V	R <sub>L</sub> = 50 kΩ	25°C	80	200	80	200	V/mV	
			Full range	50		50			
		R <sub>L</sub> = 1 MΩ	25°C	1000		1000			
r <sub>i(d)</sub> Differential input resistance		25°C	10 <sup>12</sup>		10 <sup>12</sup>		Ω		
r <sub>i(c)</sub> Common-mode input resistance		25°C	10 <sup>12</sup>		10 <sup>12</sup>		Ω		
c <sub>i(c)</sub> Common-mode input capacitance	f = 10 kHz, P package	25°C	8		8		pF		
z <sub>o</sub> Closed-loop output impedance	f = 100 kHz, A <sub>V</sub> = 10	25°C	220		220		Ω		
CMRR Common-mode rejection ratio	V <sub>IC</sub> = -5 V to 2.7 V, V <sub>O</sub> = 0, R <sub>S</sub> = 50 Ω	25°C	75	88	75	88	dB		
		Full range	75		75				
k <sub>SVR</sub> Supply-voltage rejection ratio (ΔV <sub>DD±</sub> /ΔV <sub>IO</sub> )	V <sub>DD</sub> = 4.4 V to 16 V, V <sub>IC</sub> = V <sub>DD</sub> /2, No load	25°C	80	95	80	95	dB		
		Full range	80		80				
I <sub>DD</sub> Supply current	V <sub>O</sub> = 0, No load	25°C	425	500	425	500	μA		
		Full range		500		500			

† Full range is -40°C to 125°C for Q suffix, -55°C to 125°C for M suffix.

NOTE 4: Typical values are based on the input offset voltage shift observed through 500 hours of operating life test at T<sub>A</sub> = 150°C extrapolated to T<sub>A</sub> = 25°C using the Arrhenius equation and assuming an activation energy of 0.96 eV.





**TLC2262Q/M operating characteristics at specified free-air temperature,  $V_{DD\pm} = \pm 5\text{ V}$**

PARAMETER	TEST CONDITIONS	$T_A$ †	TLC2262Q, TLC2262M			TLC2262AQ, TLC2262AM			UNIT	
			MIN	TYP	MAX	MIN	TYP	MAX		
SR	Slew rate at unity gain $V_O = \pm 2\text{ V}$ , $C_L = 100\text{ pF}$	$R_L = 50\text{ k}\Omega$	25°C	0.35	0.55		0.35	0.55	V/ $\mu\text{s}$	
			Full range	0.25			0.25			
$V_n$	Equivalent input noise voltage		25°C	43			43			nV/ $\sqrt{\text{Hz}}$
			25°C	12			12			
$V_{N(PP)}$	Peak-to-peak equivalent input noise voltage		25°C	0.8			0.8			$\mu\text{V}$
			25°C	1.3			1.3			
$I_n$	Equivalent input noise current		25°C	0.6			0.6			fA $\sqrt{\text{Hz}}$
THD + N	Total harmonic distortion plus noise $V_O = \pm 2.3\text{ V}$ , $R_L = 50\text{ k}\Omega$ , $f = 20\text{ kHz}$	$A_V = 1$	25°C	0.014%			0.014%			
			$A_V = 10$	0.024%			0.024%			
	Gain-bandwidth product $f = 10\text{ kHz}$ , $C_L = 100\text{ pF}$	$R_L = 50\text{ k}\Omega$	25°C	0.73			0.73			MHz
$B_{OM}$	Maximum output-swing bandwidth $V_{O(PP)} = 4.6\text{ V}$ , $R_L = 50\text{ k}\Omega$	$A_V = 1$ , $C_L = 100\text{ pF}$	25°C	85			85			kHz
$t_s$	Settling time $A_V = -1$ , Step = $-2.3\text{ V}$ to $2.3\text{ V}$ , $R_L = 50\text{ k}\Omega$ , $C_L = 100\text{ pF}$	To 0.1%	25°C	7.1			7.1			$\mu\text{s}$
		To 0.01%		16.5			16.5			
$\phi_m$	Phase margin at unity gain $R_L = 50\text{ k}\Omega$	$C_L = 100\text{ pF}$	25°C	57°			57°			
	Gain margin		25°C	11			11			

† Full range is  $-40^\circ\text{C}$  to  $125^\circ\text{C}$  for Q suffix,  $-55^\circ\text{C}$  to  $125^\circ\text{C}$  for M suffix.

# TLC226x, TLC226xA Advanced LinCMOS™ RAIL-TO-RAIL OPERATIONAL AMPLIFIERS

SLOS177D – FEBRUARY 1997 – REVISED MARCH 2001

**TLC2264Q/M electrical characteristics at specified free-air temperature,  $V_{DD} = 5\text{ V}$  (unless otherwise noted)**

PARAMETER	TEST CONDITIONS	$T_A$ †	TLC2264Q, TLC2264M			TLC2264AQ, TLC2264AM			UNIT
			MIN	TYP	MAX	MIN	TYP	MAX	
$V_{IO}$ Input offset voltage		25°C	300	2500		300	950	$\mu\text{V}$	
		Full range		3000		1500			
$\alpha_{VIO}$ Temperature coefficient of input offset voltage		Full range	2			2			$\mu\text{V}/^\circ\text{C}$
Input offset voltage long-term drift (see Note 4)	$V_{DD\pm} = \pm 2.5\text{ V}$ , $V_O = 0$ , $V_{IC} = 0$ , $R_S = 50\ \Omega$	25°C	0.003			0.003			$\mu\text{V}/\text{mo}$
$I_{IO}$ Input offset current		25°C	0.5			0.5			$\text{pA}$
		125°C	800			800			
$I_{IB}$ Input bias current		25°C	1			1			$\text{pA}$
	125°C	800			800				
$V_{ICR}$ Common-mode input voltage range	$R_S = 50\ \Omega$ , $ V_{IO}  \leq 5\text{ mV}$	25°C	0 to 4	-0.3 to 4.2		0 to 4	-0.3 to 4.2	V	
		Full range	0 to 3.5		0 to 3.5				
$V_{OH}$ High-level output voltage	$I_{OH} = -20\ \mu\text{A}$ $I_{OH} = -100\ \mu\text{A}$ $I_{OH} = -400\ \mu\text{A}$	25°C	4.99			4.99			V
		25°C	4.85	4.94		4.85	4.94		
		Full range	4.82			4.82			
		25°C	4.7	4.85		4.7	4.85		
$V_{OL}$ Low-level output voltage	$V_{IC} = 2.5\text{ V}$ , $I_{OL} = 50\ \mu\text{A}$ $I_{OL} = 500\ \mu\text{A}$ $I_{OL} = 4\text{ mA}$	25°C	0.01			0.01			V
		25°C	0.09	0.15		0.09	0.15		
		Full range	0.15			0.15			
		25°C	0.8	1		0.7	1		
$AVD$ Large-signal differential voltage amplification	$V_{IC} = 2.5\text{ V}$ , $V_O = 1\text{ V to }4\text{ V}$	$R_L = 50\ \text{k}\Omega^\ddagger$	25°C	80	100		80	170	V/mV
			Full range	50			50		
		$R_L = 1\ \text{M}\Omega^\ddagger$	25°C	550			550		
$r_{i(d)}$ Differential input resistance		25°C	$10^{12}$			$10^{12}$			$\Omega$
$r_{i(c)}$ Common-mode input resistance		25°C	$10^{12}$			$10^{12}$			$\Omega$
$C_{i(c)}$ Common-mode input capacitance	$f = 10\text{ kHz}$ , N package	25°C	8			8			$\text{pF}$
$z_o$ Closed-loop output impedance	$f = 100\text{ kHz}$ , $A_V = 10$	25°C	240			240			$\Omega$
CMRR Common-mode rejection ratio	$V_{IC} = 0\text{ to }2.7\text{ V}$ , $V_O = 2.5\text{ V}$ , $R_S = 50\ \Omega$	25°C	70	83		70	83	dB	
		Full range	70			70			
$k_{SVR}$ Supply-voltage rejection ratio ( $\Delta V_{DD}/\Delta V_{IO}$ )	$V_{DD} = 4.4\text{ V to }16\text{ V}$ ,	25°C	80	95		80	95	dB	
$I_{DD}$ Supply current (four amplifiers)	$V_O = 2.5\text{ V}$ , No load	25°C	0.8	1		0.8	1	mA	
		Full range	1			1			

† Full range is  $-40^\circ\text{C}$  to  $125^\circ\text{C}$  for Q suffix,  $-55^\circ\text{C}$  to  $125^\circ\text{C}$  for M suffix.

‡ Referenced to 2.5 V

NOTE 4: Typical values are based on the input offset voltage shift observed through 500 hours of operating life test at  $T_A = 150^\circ\text{C}$  extrapolated to  $T_A = 25^\circ\text{C}$  using the Arrhenius equation and assuming an activation energy of 0.96 eV.



**TLC2264Q/M operating characteristics at specified free-air temperature,  $V_{DD} = 5\text{ V}$**

PARAMETER	TEST CONDITIONS	$T_A$ †	TLC2264Q, TLC2264M			TLC2264AQ, TLC2264AM			UNIT
			MIN	TYP	MAX	MIN	TYP	MAX	
SR	Slew rate at unity gain $V_O = 0.5\text{ V to }3.5\text{ V}, R_L = 50\text{ k}\Omega^\ddagger, C_L = 100\text{ pF}^\ddagger$	25°C	0.35	0.55		0.35	0.55		V/ $\mu$ s
		Full range	0.25			0.25			
$V_n$	Equivalent input noise voltage	f = 10 Hz	40			40			nV/ $\sqrt{\text{Hz}}$
		f = 1 kHz	12			12			
$V_{N(PP)}$	Peak-to-peak equivalent input noise voltage	f = 0.1 Hz to 1 Hz	0.7			0.7			$\mu$ V
		f = 0.1 Hz to 10 Hz	1.3			1.3			
$I_n$	Equivalent input noise current	25°C	0.6			0.6			fA/ $\sqrt{\text{Hz}}$
THD + N	Total harmonic distortion plus noise $V_O = 0.5\text{ V to }2.5\text{ V}, f = 20\text{ kHz}, R_L = 50\text{ k}\Omega^\ddagger$	$A_V = 1$	0.017%			0.017%			
		$A_V = 10$	0.03%			0.03%			
	Gain-bandwidth product f = 50 kHz, $C_L = 100\text{ pF}^\ddagger$	$R_L = 50\text{ k}\Omega^\ddagger, 25^\circ\text{C}$	0.71			0.71			MHz
$B_{OM}$	Maximum output-swing bandwidth $V_{O(PP)} = 2\text{ V}, R_L = 50\text{ k}\Omega^\ddagger, A_V = 1, C_L = 100\text{ pF}^\ddagger$	25°C	185			185			kHz
$t_s$	Settling time $A_V = -1, \text{ Step} = 0.5\text{ V to }2.5\text{ V}, R_L = 50\text{ k}\Omega^\ddagger, C_L = 100\text{ pF}^\ddagger$	To 0.1%	6.4			6.4			$\mu$ s
		To 0.01%	14.1			14.1			
$\phi_m$	Phase margin at unity gain $R_L = 50\text{ k}\Omega^\ddagger, C_L = 100\text{ pF}^\ddagger$	25°C	56°			56°			
		25°C	11			11			

† Full range is  $-40^\circ\text{C}$  to  $125^\circ\text{C}$  for Q suffix,  $-55^\circ\text{C}$  to  $125^\circ\text{C}$  for M suffix.

‡ Referenced to 2.5 V

# TLC226x, TLC226xA Advanced LinCMOS™ RAIL-TO-RAIL OPERATIONAL AMPLIFIERS

SLOS177D – FEBRUARY 1997 – REVISED MARCH 2001

**TLC2264Q/M electrical characteristics at specified free-air temperature,  $V_{DD\pm} = \pm 5\text{ V}$  (unless otherwise noted)**

PARAMETER	TEST CONDITIONS	$T_A$ †	TLC2264Q, TLC2264M			TLC2264AQ, TLC2264AM			UNIT
			MIN	TYP	MAX	MIN	TYP	MAX	
$V_{IO}$ Input offset voltage	$V_{IC} = 0, V_O = 0, R_S = 50\ \Omega$	25°C	300	2500		300	950	$\mu\text{V}$	
		Full range			3000		1500		
$\alpha_{VIO}$ Temperature coefficient of input offset voltage		Full range		2			2	$\mu\text{V}/^\circ\text{C}$	
Input offset voltage long-term drift (see Note 4)		25°C		0.003			0.003	$\mu\text{V}/\text{mo}$	
$I_{IO}$ Input offset current		25°C		0.5			0.5	pA	
		125°C			800		800		
$I_{IB}$ Input bias current	25°C		1			1	pA		
	125°C			800		800			
$V_{ICR}$ Common-mode input voltage range	$R_S = 50\ \Omega,  V_{IO}  \leq 5\ \text{mV}$	25°C	-5 to 4	-5.3 to 4.2		-5 to 4	-5.3 to 4.2	V	
		Full range	-5 to 3.5			-5 to 3.5			
$V_{OM+}$ Maximum positive peak output voltage	$I_O = -20\ \mu\text{A}$	25°C		4.99			4.99	V	
	$I_O = -100\ \mu\text{A}$	25°C	4.85	4.94		4.85	4.94		
		Full range	4.82			4.82			
	$I_O = -400\ \mu\text{A}$	25°C	4.7	4.85		4.7	4.85		
Full range		4.5			4.5				
$V_{OM-}$ Maximum negative peak output voltage	$V_{IC} = 0, I_O = 50\ \mu\text{A}$	25°C		-4.99			-4.99	V	
	$V_{IC} = 0, I_O = 500\ \mu\text{A}$	25°C	-4.85	-4.91		-4.85	-4.91		
		Full range	-4.85			-4.85			
	$V_{IC} = 0, I_O = 4\ \text{mA}$	25°C	-4	-4.3		-4	-4.3		
Full range		-3.8			-3.8				
$A_{VD}$ Large-signal differential voltage amplification	$V_O = \pm 4\ \text{V}$	$R_L = 50\ \text{k}\Omega$	25°C	80	200		80	200	V/mV
			Full range	50			50		
		$R_L = 1\ \text{M}\Omega$	25°C		1000			1000	
$r_{i(d)}$ Differential input resistance		25°C		$10^{12}$			$10^{12}$	$\Omega$	
$r_{i(c)}$ Common-mode input resistance		25°C		$10^{12}$			$10^{12}$	$\Omega$	
$C_{i(c)}$ Common-mode input capacitance	$f = 10\ \text{kHz}, \text{N package}$	25°C		8			8	pF	
$z_o$ Closed-loop output impedance	$f = 100\ \text{kHz}, A_V = 10$	25°C		220			220	$\Omega$	
CMRR Common-mode rejection ratio	$V_{IC} = -5\ \text{V to } 2.7\ \text{V}, V_O = 0, R_S = 50\ \Omega$	25°C	75	88		75	88	dB	
		Full range	75			75			
$k_{SVR}$ Supply-voltage rejection ratio ( $\Delta V_{DD\pm}/\Delta V_{IO}$ )	$V_{DD\pm} = \pm 2.2\ \text{V to } \pm 8\ \text{V}, V_{IC} = V_{DD}/2, \text{No load}$	25°C	80	95		80	95	dB	
		Full range	80			80			
$I_{DD}$ Supply current (four amplifiers)	$V_O = 0, \text{No load}$	25°C		0.85	1		0.85	1	mA
		Full range			1			1	

† Full range is  $-40^\circ\text{C}$  to  $125^\circ\text{C}$  for Q suffix,  $-55^\circ\text{C}$  to  $125^\circ\text{C}$  for M suffix.

NOTE 4: Typical values are based on the input offset voltage shift observed through 500 hours of operating life test at  $T_A = 150^\circ\text{C}$  extrapolated to  $T_A = 25^\circ\text{C}$  using the Arrhenius equation and assuming an activation energy of 0.96 eV.



**TLC2264Q/M operating characteristics at specified free-air temperature,  $V_{DD\pm} = \pm 5\text{ V}$**

PARAMETER	TEST CONDITIONS	$T_A$ †	TLC2264Q, TLC2264M			TLC2264AQ, TLC2264AM			UNIT	
			MIN	TYP	MAX	MIN	TYP	MAX		
SR	Slew rate at unity gain $V_O = \pm 2\text{ V}$ , $C_L = 100\text{ pF}$	$R_L = 50\text{ k}\Omega$	25°C	0.35	0.55		0.35	0.55	V/ $\mu\text{s}$	
			Full range	0.25		0.25				
$V_n$	Equivalent input noise voltage		25°C	43			43			nV/ $\sqrt{\text{Hz}}$
			25°C	12			12			
$V_{N(PP)}$	Peak-to-peak equivalent input noise voltage		25°C	0.8			0.8			$\mu\text{V}$
			25°C	1.3			1.3			
$I_n$	Equivalent input noise current		25°C	0.6			0.6			fA/ $\sqrt{\text{Hz}}$
THD + N	Total harmonic distortion plus noise $V_O = \pm 2.3\text{ V}$ , $R_L = 50\text{ k}\Omega$ , $f = 20\text{ kHz}$		25°C	$A_V = 1$			0.014%			
				$A_V = 10$			0.024%			
	Gain-bandwidth product $f = 10\text{ kHz}$ , $C_L = 100\text{ pF}$	$R_L = 50\text{ k}\Omega$	25°C	0.73			0.73			MHz
$B_{OM}$	Maximum output-swing bandwidth $V_{O(PP)} = 4.6\text{ V}$ , $R_L = 50\text{ k}\Omega$	$A_V = 1$ , $C_L = 100\text{ pF}$	25°C	70			70			kHz
$t_s$	Settling time $A_V = -1$ , Step = $-2.3\text{ V}$ to $2.3\text{ V}$ , $R_L = 50\text{ k}\Omega$ , $C_L = 100\text{ pF}$		25°C	To 0.1%			7.1			$\mu\text{s}$
				To 0.01%			16.5			
$\phi_m$	Phase margin at unity gain $R_L = 50\text{ k}\Omega$ , $C_L = 100\text{ pF}$		25°C	57°			57°			
	Gain margin		25°C	11			11			

† Full range is  $-40^\circ\text{C}$  to  $125^\circ\text{C}$  for Q suffix,  $-55^\circ\text{C}$  to  $125^\circ\text{C}$  for M suffix.

**TLC226x, TLC226xA**  
**Advanced LinCMOS™ RAIL-TO-RAIL**  
**OPERATIONAL AMPLIFIERS**

SLOS177D – FEBRUARY 1997 – REVISED MARCH 2001

**TYPICAL CHARACTERISTICS**

**Table of Graphs**

			<b>FIGURE</b>
$V_{IO}$	Input offset voltage	Distribution vs Common-mode input voltage	2 – 5 6, 7
$\alpha V_{IO}$	Input offset voltage temperature coefficient	Distribution	8 – 11
$I_{IB}/I_{IO}$	Input bias and input offset currents	vs Free-air temperature	12
$V_I$	Input voltage range	vs Supply voltage vs Free-air temperature	13 14
$V_{OH}$	High-level output voltage	vs High-level output current	15
$V_{OL}$	Low-level output voltage	vs Low-level output current	16, 17
$V_{OM+}$	Maximum positive output voltage	vs Output current	18
$V_{OM-}$	Maximum negative output voltage	vs Output current	19
$V_{O(PP)}$	Maximum peak-to-peak output voltage	vs Frequency	20
$I_{OS}$	Short-circuit output current	vs Supply voltage vs Free-air temperature	21 22
$V_O$	Output voltage	vs Differential input voltage	23, 24
	Differential gain	vs Load resistance	25
$A_{VD}$	Large-signal differential voltage amplification	vs Frequency vs Free-air temperature	26, 27 28, 29
$z_o$	Output impedance	vs Frequency	30, 31
CMRR	Common-mode rejection ratio	vs Frequency vs Free-air temperature	32 33
$k_{SVR}$	Supply-voltage rejection ratio	vs Frequency vs Free-air temperature	34, 35 36
$I_{DD}$	Supply current	vs Supply voltage vs Free-air temperature	37, 38 39, 40
SR	Slew rate	vs Load capacitance vs Free-air temperature	41 42
$V_O$	Inverting large-signal pulse response		43, 44
	Voltage-follower large-signal pulse response		45, 46
	Inverting small-signal pulse response		47, 48
	Voltage-follower small-signal pulse response		49, 50
$V_n$	Equivalent input noise voltage	vs Frequency	51, 52
	Noise voltage (referred to input)	Over a 10-second period	53
	Integrated noise voltage	vs Frequency	54
THD + N	Total harmonic distortion plus noise	vs Frequency	55
	Gain-bandwidth product	vs Supply voltage vs Free-air temperature	56 57
$\phi_m$	Phase margin	vs Frequency vs Load capacitance	26, 27 58
	Gain margin	vs Load capacitance	59
$B_1$	Unity-gain bandwidth	vs Load capacitance	60
	Overestimation of phase margin	vs Load capacitance	61



TYPICAL CHARACTERISTICS

DISTRIBUTION OF TLC2262  
 INPUT OFFSET VOLTAGE



Figure 2

DISTRIBUTION OF TLC2262  
 INPUT OFFSET VOLTAGE



Figure 3

DISTRIBUTION OF TLC2264  
 INPUT OFFSET VOLTAGE



Figure 4

DISTRIBUTION OF TLC2264  
 INPUT OFFSET VOLTAGE



Figure 5

**TYPICAL CHARACTERISTICS**



**Figure 6**



**Figure 7**

† For curves where  $V_{DD} = 5\text{ V}$ , all loads are referenced to 2.5 V.



**Figure 8**



**Figure 9**

† Data at high and low temperatures are applicable only within the rated operating free-air temperature ranges of the various devices.



TYPICAL CHARACTERISTICS



Figure 10

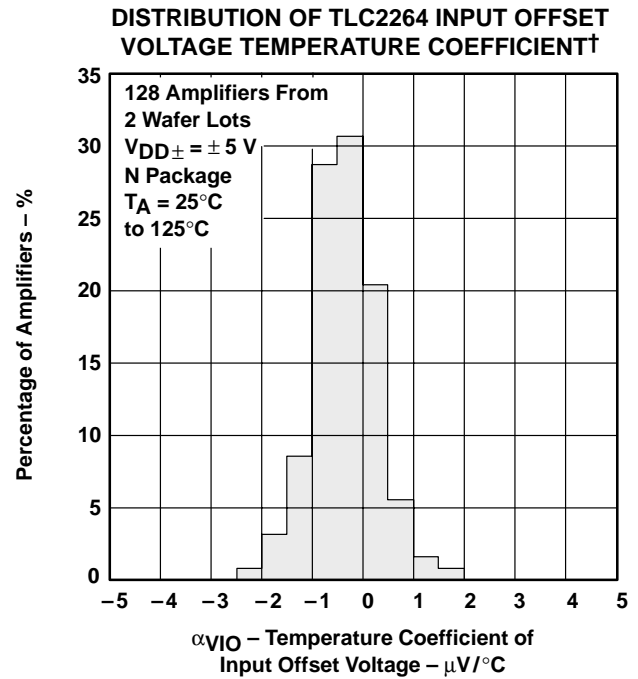

Figure 11



Figure 12

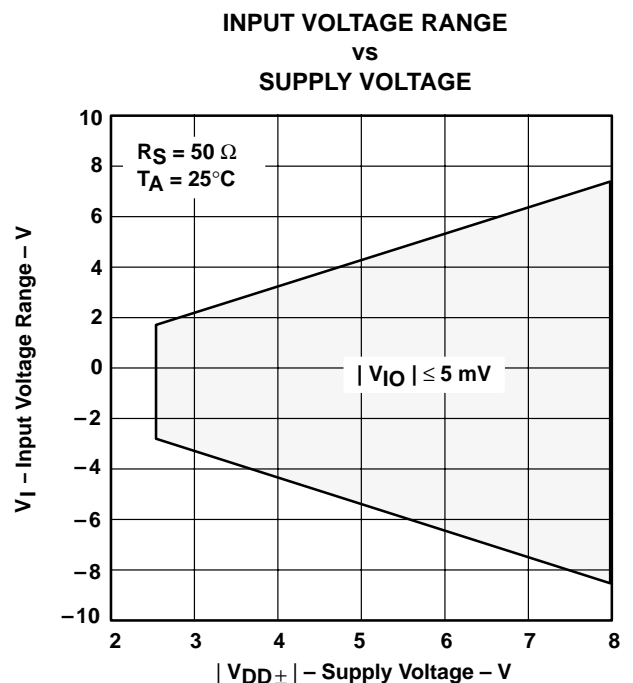

Figure 13

† Data at high and low temperatures are applicable only within the rated operating free-air temperature ranges of the various devices.

TYPICAL CHARACTERISTICS

INPUT VOLTAGE RANGE†‡  
 vs  
 FREE-AIR TEMPERATURE



Figure 14

HIGH-LEVEL OUTPUT VOLTAGE†‡  
 vs  
 HIGH-LEVEL OUTPUT CURRENT



Figure 15

LOW-LEVEL OUTPUT VOLTAGE‡  
 vs  
 LOW-LEVEL OUTPUT CURRENT



Figure 16

LOW-LEVEL OUTPUT VOLTAGE†‡  
 vs  
 LOW-LEVEL OUTPUT CURRENT



Figure 17

† Data at high and low temperatures are applicable only within the rated operating free-air temperature ranges of the various devices.

‡ For curves where  $V_{DD} = 5\text{ V}$ , all loads are referenced to 2.5 V.

TYPICAL CHARACTERISTICS

MAXIMUM POSITIVE OUTPUT VOLTAGE†  
 vs  
 OUTPUT CURRENT



Figure 18

MAXIMUM NEGATIVE OUTPUT VOLTAGE†  
 vs  
 OUTPUT CURRENT



Figure 19

MAXIMUM PEAK-TO-PEAK OUTPUT VOLTAGE‡  
 vs  
 FREQUENCY

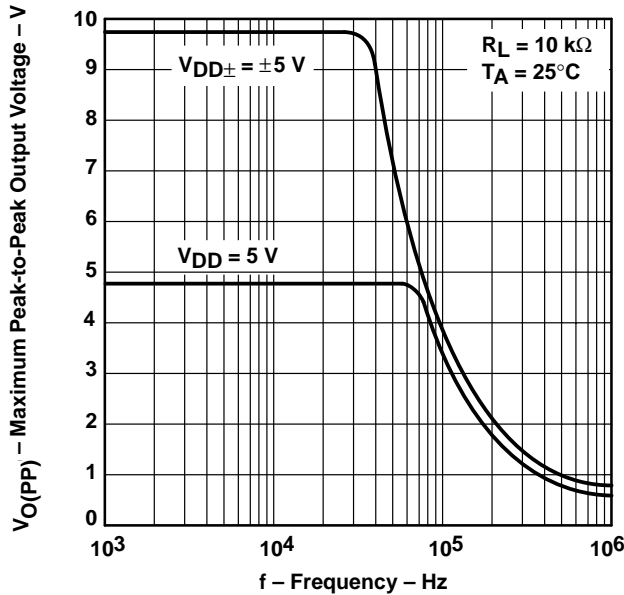

Figure 20

SHORT-CIRCUIT OUTPUT CURRENT  
 vs  
 SUPPLY VOLTAGE

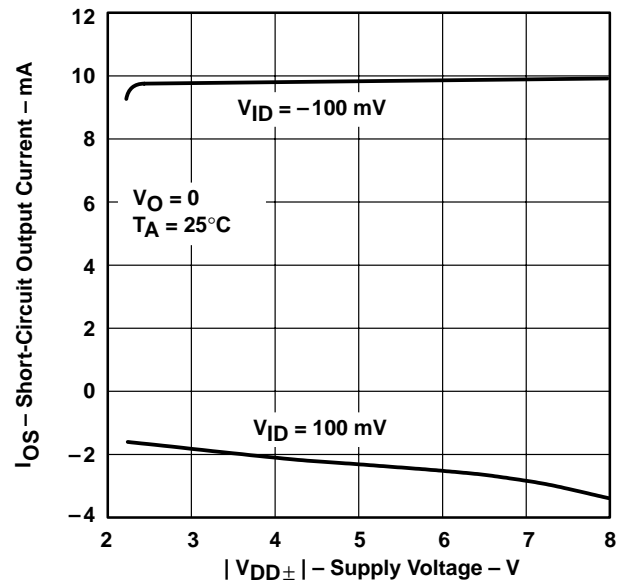

Figure 21

‡ For curves where  $V_{DD} = 5$  V, all loads are referenced to 2.5 V.

† Data at high and low temperatures are applicable only within the rated operating free-air temperature ranges of the various devices.

**TLC226x, TLC226xA**  
**Advanced LinCMOS™ RAIL-TO-RAIL**  
**OPERATIONAL AMPLIFIERS**

SLOS177D – FEBRUARY 1997 – REVISED MARCH 2001

**TYPICAL CHARACTERISTICS**

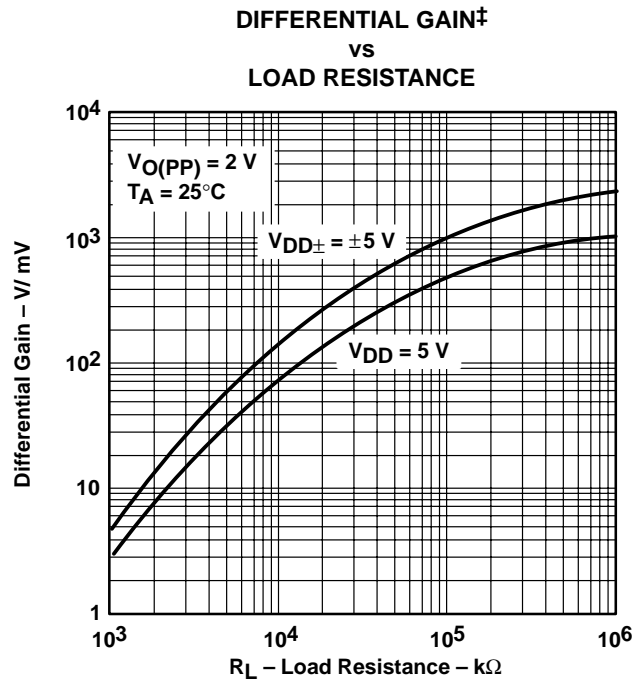
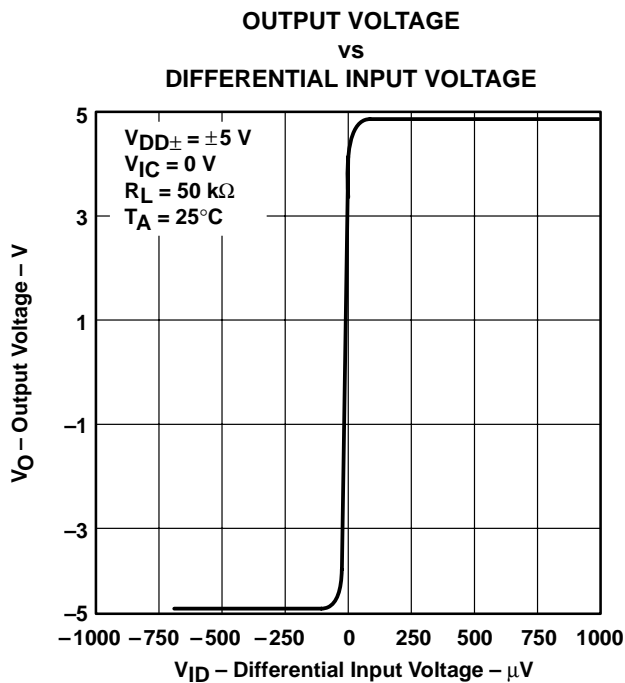
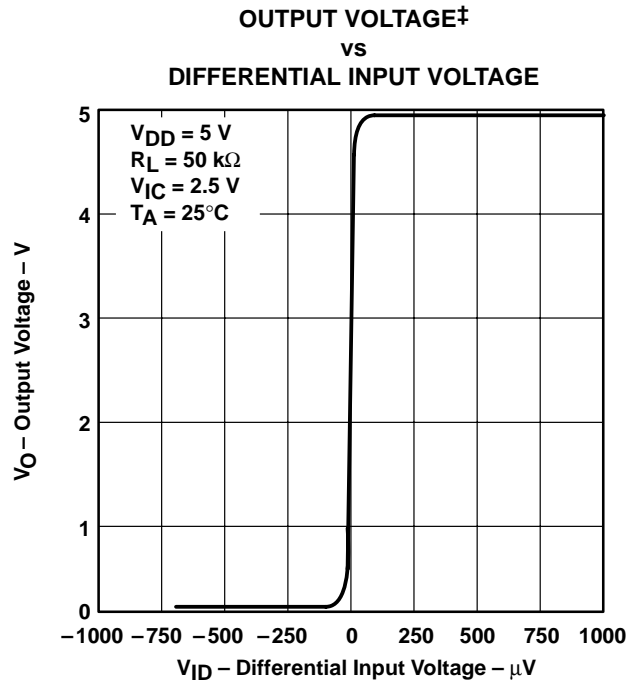
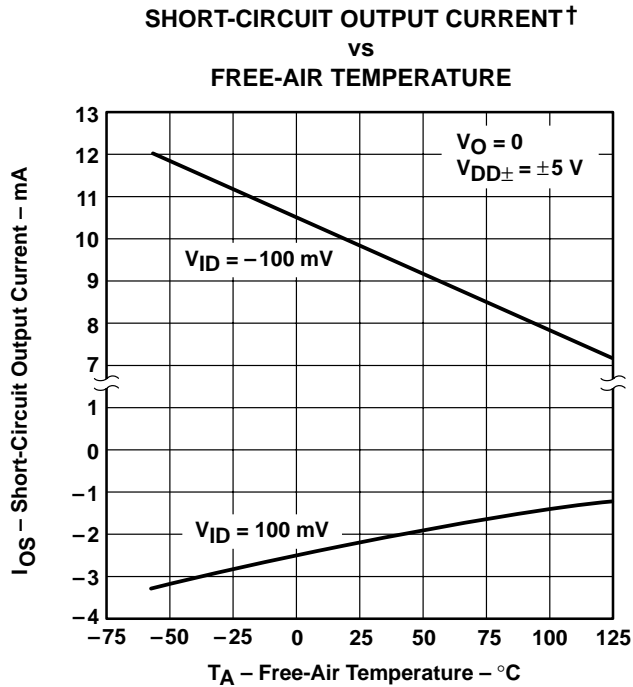

† Data at high and low temperatures are applicable only within the rated operating free-air temperature ranges of the various devices.

‡ For curves where  $V_{DD} = 5\text{ V}$ , all loads are referenced to 2.5 V.



TYPICAL CHARACTERISTICS

LARGE-SIGNAL DIFFERENTIAL VOLTAGE†  
 AMPLIFICATION AND PHASE MARGIN  
 VS  
 FREQUENCY



† For curves where  $V_{DD} = 5\text{ V}$ , all loads are referenced to 2.5 V.

Figure 26

LARGE-SIGNAL DIFFERENTIAL VOLTAGE  
 AMPLIFICATION AND PHASE MARGIN  
 VS  
 FREQUENCY

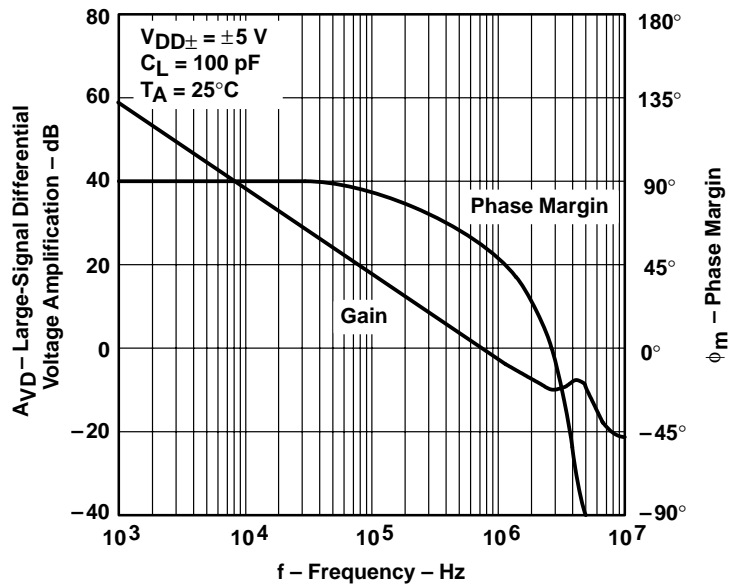

Figure 27

**TYPICAL CHARACTERISTICS**

**LARGE-SIGNAL DIFFERENTIAL VOLTAGE AMPLIFICATION†‡**  
**vs**  
**FREE-AIR TEMPERATURE**



**Figure 28**

**LARGE-SIGNAL DIFFERENTIAL VOLTAGE AMPLIFICATION†**  
**vs**  
**FREE-AIR TEMPERATURE**



**Figure 29**

**OUTPUT IMPEDANCE‡**  
**vs**  
**FREQUENCY**



**Figure 30**

**OUTPUT IMPEDANCE**  
**vs**  
**FREQUENCY**

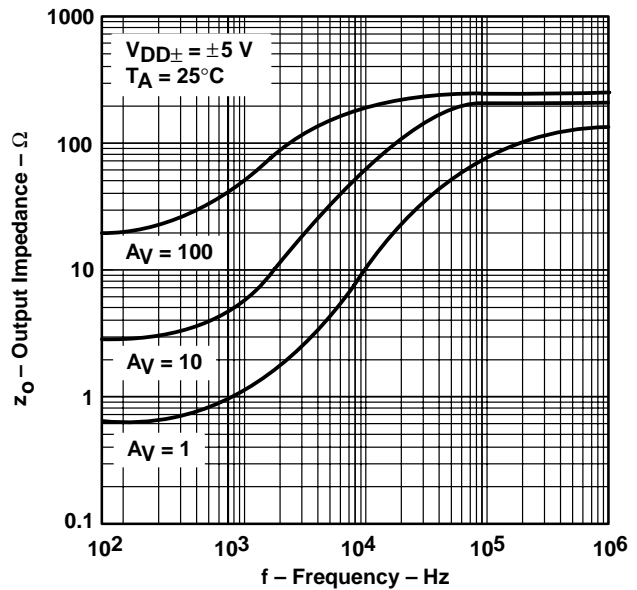

**Figure 31**

† Data at high and low temperatures are applicable only within the rated operating free-air temperature ranges of the various devices.

‡ For curves where  $V_{DD} = 5\text{ V}$ , all loads are referenced to 2.5 V.

TYPICAL CHARACTERISTICS



Figure 32



Figure 33



Figure 34

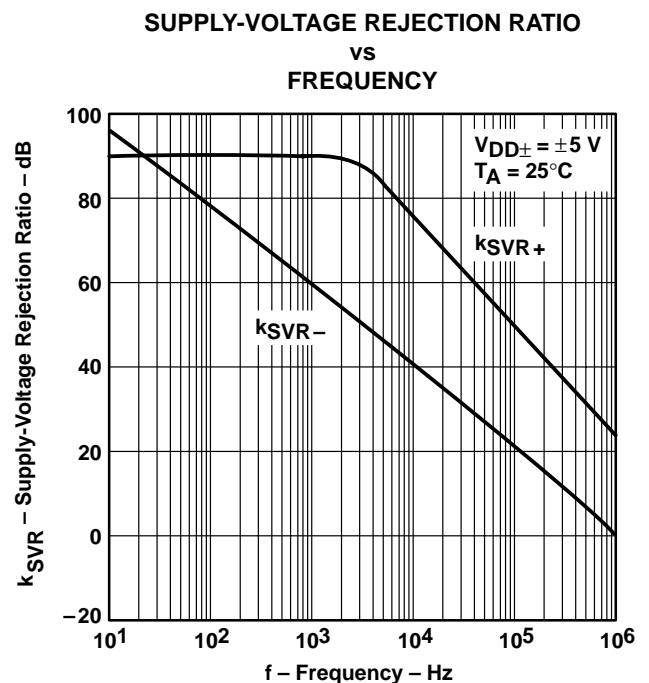

Figure 35

† For curves where VDD = 5 V, all loads are referenced to 2.5 V.

‡ Data at high and low temperatures are applicable only within the rated operating free-air temperature ranges of the various devices.

TYPICAL CHARACTERISTICS

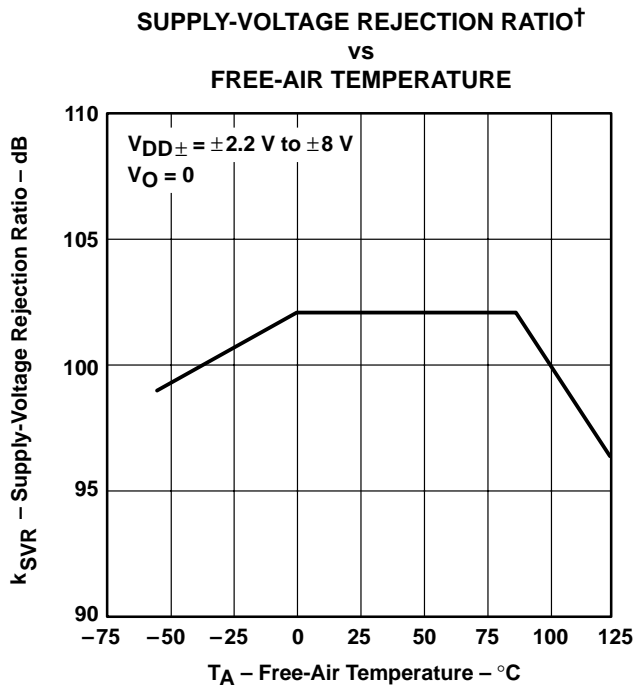

Figure 36

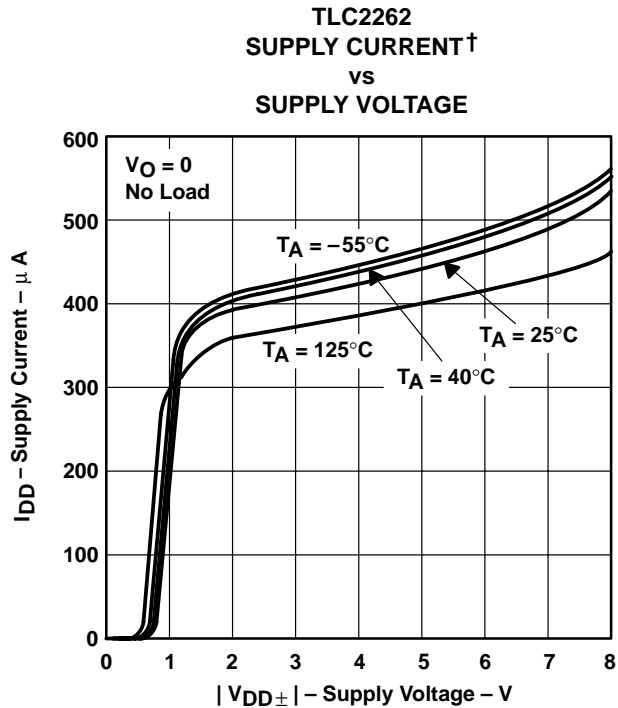

Figure 37

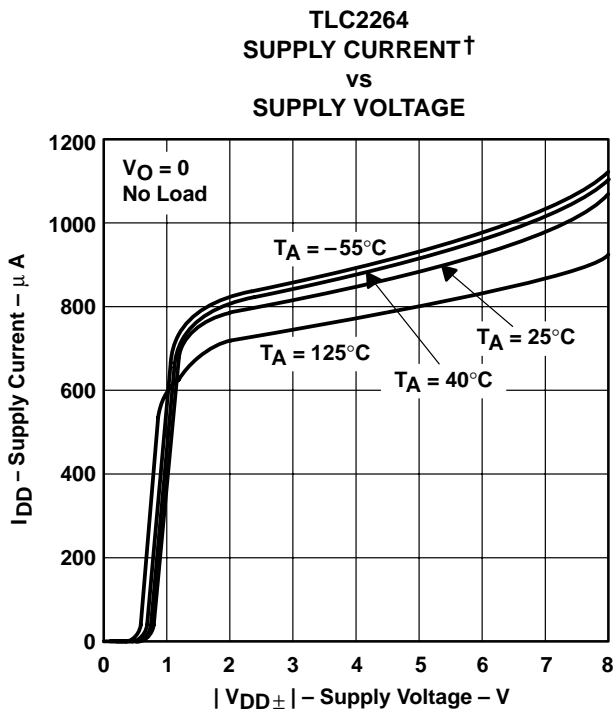

Figure 38

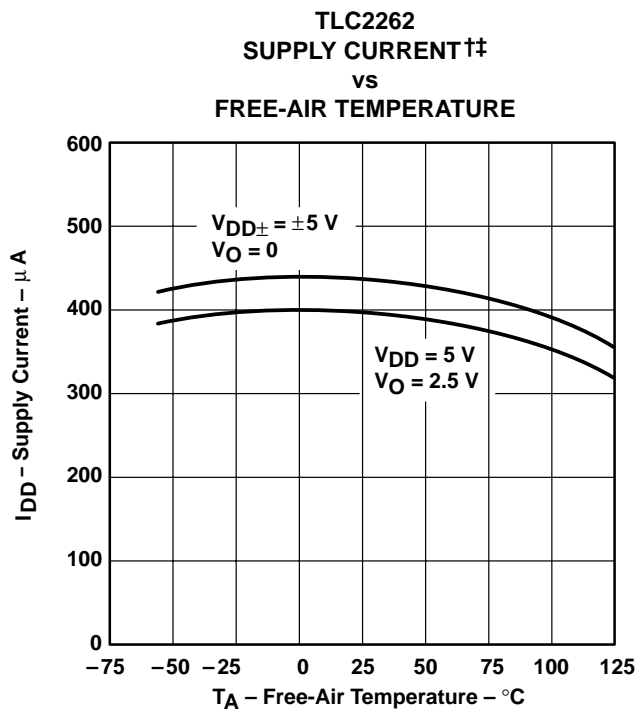

Figure 39

† Data at high and low temperatures are applicable only within the rated operating free-air temperature ranges of the various devices.

†† For curves where  $V_{DD} = 5 \text{ V}$ , all loads are referenced to 2.5 V.



TYPICAL CHARACTERISTICS



† Data at high and low temperatures are applicable only within the rated operating free-air temperature ranges of the various devices.

‡ For curves where  $V_{DD} = 5\text{ V}$ , all loads are referenced to 2.5 V.

**TYPICAL CHARACTERISTICS**

**INVERTING LARGE-SIGNAL PULSE RESPONSE**



**Figure 44**

**VOLTAGE-FOLLOWER LARGE-SIGNAL PULSE RESPONSE†**

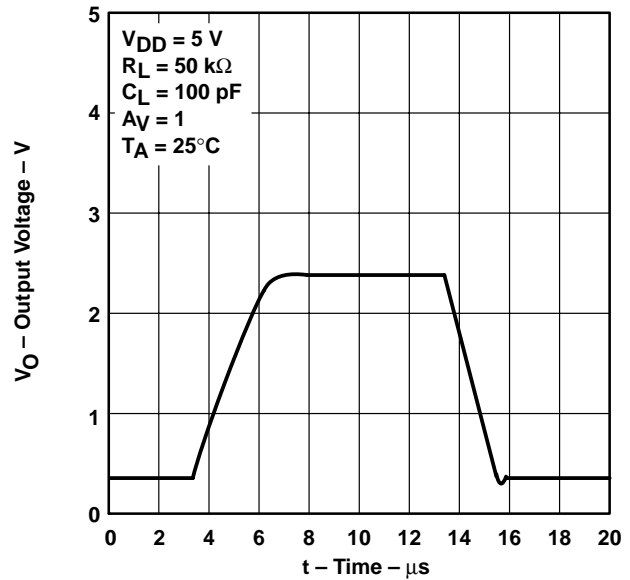

**Figure 45**

**VOLTAGE-FOLLOWER LARGE-SIGNAL PULSE RESPONSE**

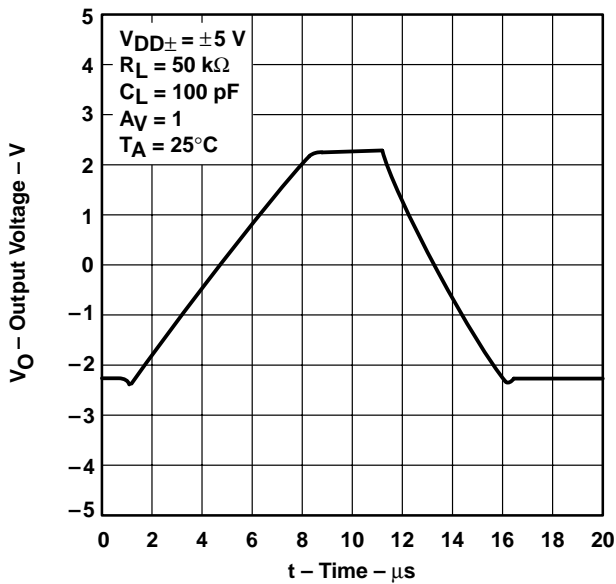

**Figure 46**

**INVERTING SMALL-SIGNAL PULSE RESPONSE†**

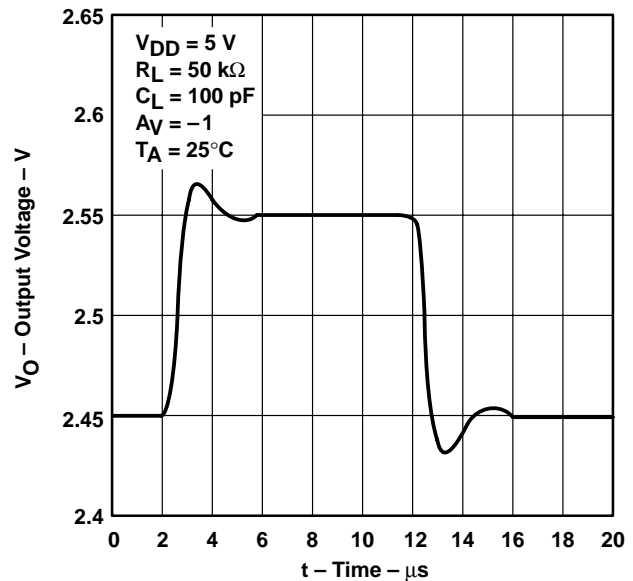

**Figure 47**

† For curves where  $V_{DD} = 5\text{ V}$ , all loads are referenced to 2.5 V.

TYPICAL CHARACTERISTICS



Figure 48

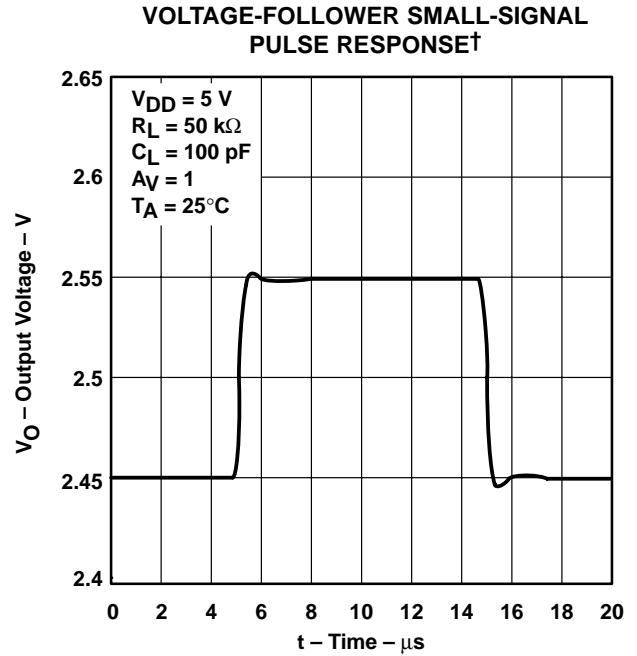

Figure 49

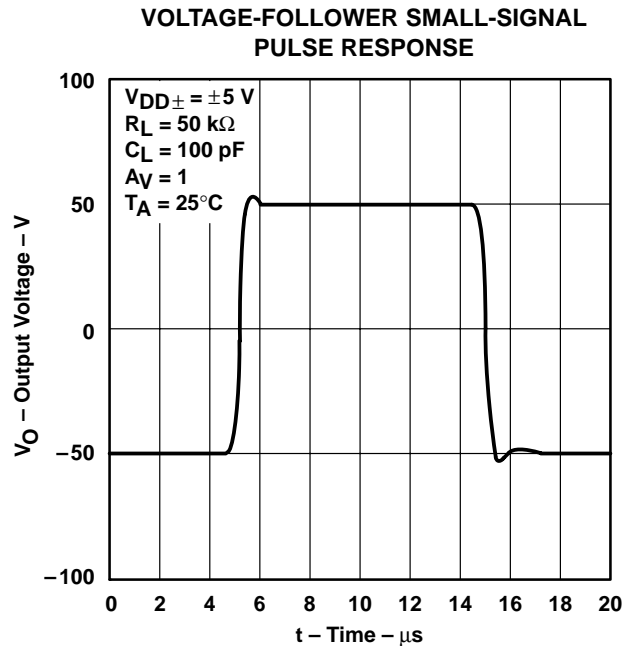

Figure 50

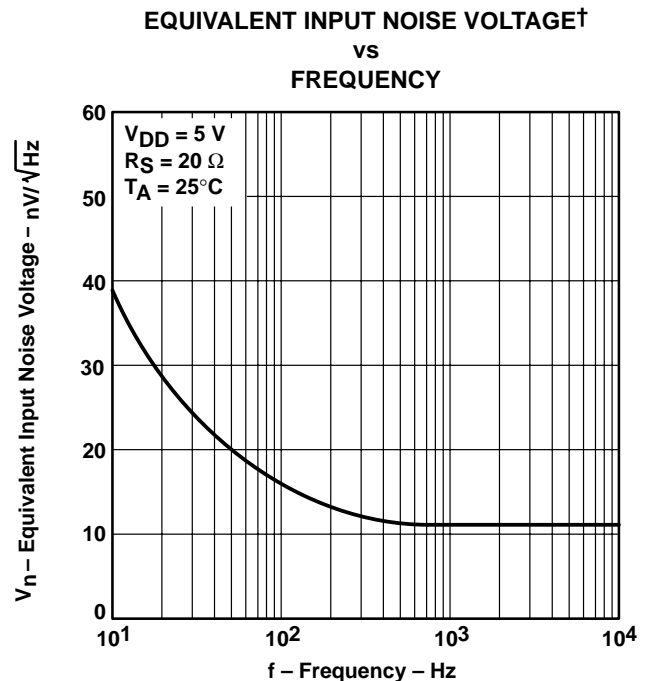

Figure 51

† For curves where  $V_{DD} = 5\text{ V}$ , all loads are referenced to 2.5 V.

TYPICAL CHARACTERISTICS

EQUIVALENT INPUT NOISE VOLTAGE  
 VS  
 FREQUENCY

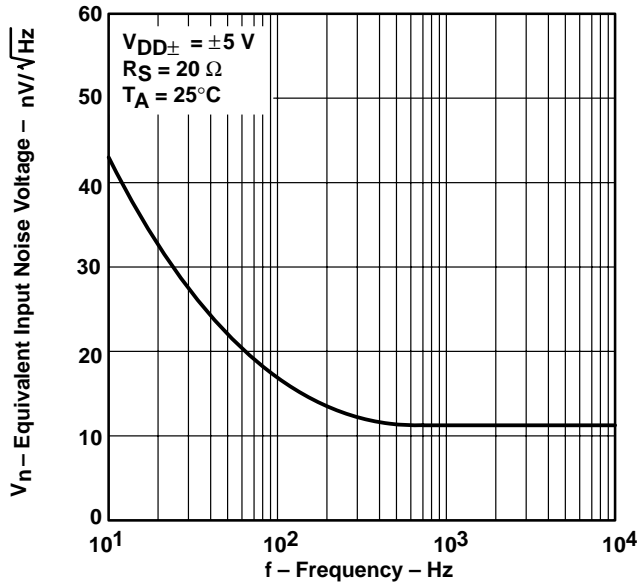

Figure 52

EQUIVALENT INPUT NOISE VOLTAGE OVER  
 A 10-SECOND PERIOD†

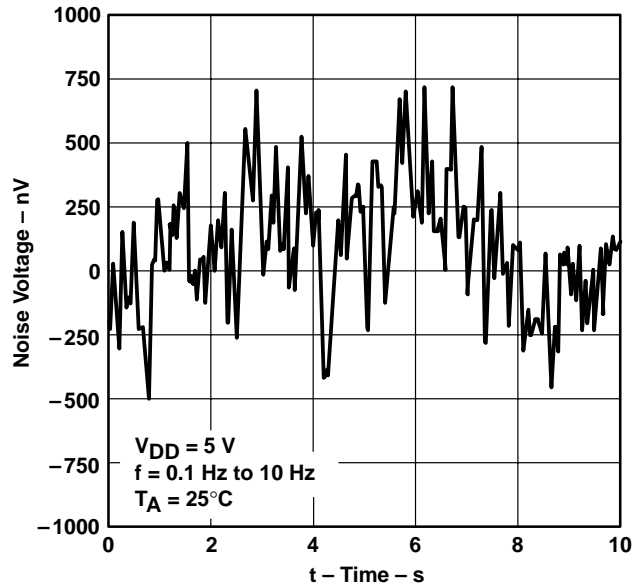

Figure 53

INTEGRATED NOISE VOLTAGE  
 VS  
 FREQUENCY

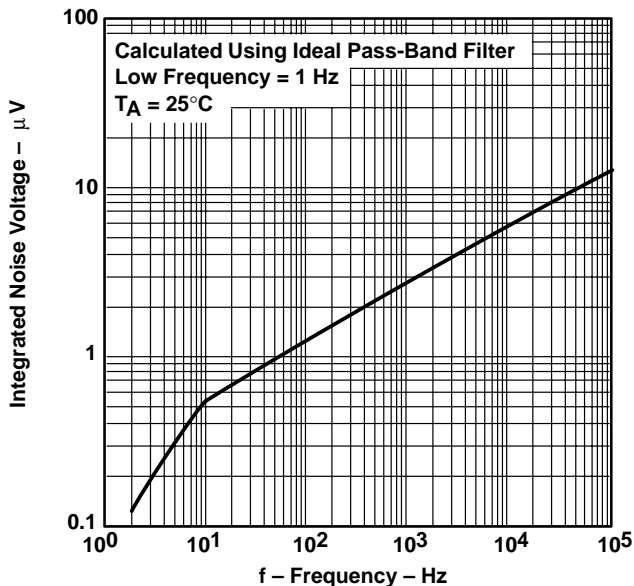

Figure 54

TOTAL HARMONIC DISTORTION PLUS NOISE†  
 VS  
 FREQUENCY

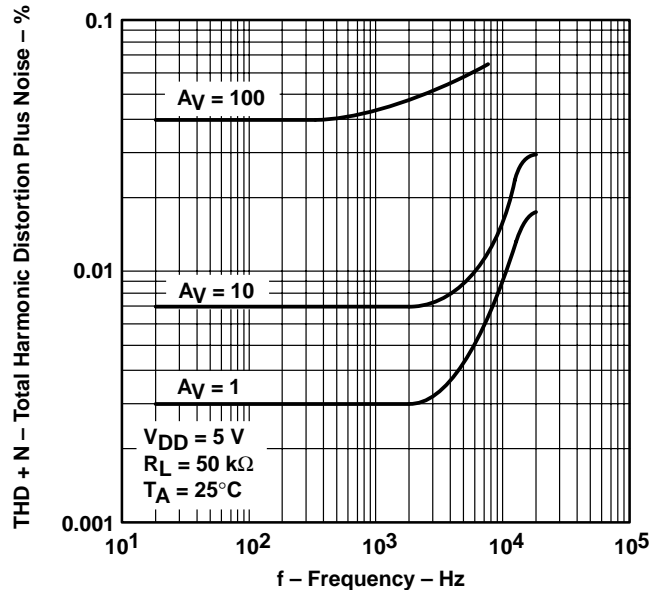

Figure 55

† For curves where  $V_{DD} = 5\text{ V}$ , all loads are referenced to 2.5 V.

TYPICAL CHARACTERISTICS

GAIN-BANDWIDTH PRODUCT  
vs  
SUPPLY VOLTAGE



Figure 56

GAIN-BANDWIDTH PRODUCT†‡  
vs  
FREE-AIR TEMPERATURE



Figure 57

PHASE MARGIN  
vs  
LOAD CAPACITANCE



Figure 58

GAIN MARGIN  
vs  
LOAD CAPACITANCE



Figure 59

† Data at high and low temperatures are applicable only within the rated operating free-air temperature ranges of the various devices.

‡ For curves where  $V_{DD} = 5\text{ V}$ , all loads are referenced to 2.5 V.

TYPICAL CHARACTERISTICS



Figure 60



Figure 61

† See application information

## APPLICATION INFORMATION

### driving large capacitive loads

The TLC226x is designed to drive larger capacitive loads than most CMOS operational amplifiers. Figure 58 and Figure 59 illustrate its ability to drive loads greater than 400 pF while maintaining good gain and phase margins ( $R_{null} = 0$ ).

A smaller series resistor ( $R_{null}$ ) at the output of the device (see Figure 62) improves the gain and phase margins when driving large capacitive loads. Figure 58 and Figure 59 show the effects of adding series resistances of 10  $\Omega$ , 20  $\Omega$ , 50  $\Omega$ , and 100  $\Omega$ . The addition of this series resistor has two effects: the first is that it adds a zero to the transfer function and the second is that it reduces the frequency of the pole associated with the output load in the transfer function.

The zero introduced to the transfer function is equal to the series resistance times the load capacitance. To calculate the improvement in phase margin, equation 1 can be used.

$$\Delta\theta_{m1} = \tan^{-1} \left( 2 \times \pi \times \text{UGBW} \times R_{null} \times C_L \right) \quad (1)$$

Where :

- $\Delta\theta_{m1}$  = improvement in phase margin
- UGBW = unity-gain bandwidth frequency
- $R_{null}$  = output series resistance
- $C_L$  = load capacitance

The unity-gain bandwidth (UGBW) frequency decreases as the capacitive load increases (see Figure 60). To use equation 1, UGBW must be approximated from Figure 60.

Using equation 1 alone overestimates the improvement in phase margin, as illustrated in Figure 61. The overestimation is caused by the decrease in the frequency of the pole associated with the load, thus providing additional phase shift and reducing the overall improvement in phase margin. The pole associated with the load is reduced by the factor calculated in equation 2.

$$F = \frac{1}{1 + g_m \times R_{null}} \quad (2)$$

Where :

- F = factor reducing frequency of pole
- $g_m$  = small-signal output transconductance (typically  $4.83 \times 10^{-3}$  mhos)
- $R_{null}$  = output series resistance

For the TLC226x, the pole associated with the load is typically 7 MHz with 100-pF load capacitance. This value varies inversely with  $C_L$ : at  $C_L = 10$  pF, use 70 MHz, at  $C_L = 1000$  pF, use 700 kHz, and so on.

Reducing the pole associated with the load introduces phase shift, thereby reducing phase margin. This results in an error in the increase in phase margin expected by considering the zero alone (equation 1). Equation 3 approximates the reduction in phase margin due to the movement of the pole associated with the load. The result of this equation can be subtracted from the result of the equation in equation 1 to better approximate the improvement in phase margin.

**APPLICATION INFORMATION**

**driving large capacitive loads (continued)**

$$\Delta\theta_{m2} = \tan^{-1} \left[ \frac{UGBW}{(F \times P_2)} \right] - \tan^{-1} \left( \frac{UGBW}{P_2} \right) \tag{3}$$

Where :

$\Delta\theta_{m2}$  = reduction in phase margin

UGBW = unity-gain bandwidth frequency

F = factor from equation 2

$P_2$  = unadjusted pole (70 MHz @10 pF, 7 MHz @100 pF, etc.)

Using these equations with Figure 60 and Figure 61 enables the designer to choose the appropriate output series resistance to optimize the design of circuits driving large capacitive loads.



**Figure 62. Series-Resistance Circuit**



APPLICATION INFORMATION

macromodel information

Macromodel information provided was derived using Microsim *Parts*™, the model generation software used with Microsim *PSpice*™. The Boyle macromodel (see Note 5) and subcircuit in Figure 63 are generated using the TLC226x typical electrical and operating characteristics at  $T_A = 25^\circ\text{C}$ . Using this information, output simulations of the following key parameters can be generated to a tolerance of 20% (in most cases):

- Maximum positive output voltage swing
- Maximum negative output voltage swing
- Slew rate
- Quiescent power dissipation
- Input bias current
- Open-loop voltage amplification
- Unity-gain frequency
- Common-mode rejection ratio
- Phase margin
- DC output resistance
- AC output resistance
- Short-circuit output current limit

NOTE 5: G. R. Boyle, B. M. Cohn, D. O. Pederson, and J. E. Solomon, "Macromodeling of Integrated Circuit Operational Amplifiers," *IEEE Journal of Solid-State Circuits*, SC-9, 353 (1974).



Figure 63. Boyle Macromodel and Subcircuit

*PSpice* and *Parts* are trademarks of MicroSim Corporation.

**PACKAGING INFORMATION**

Orderable Device	Status (1)	Package Type	Package Drawing	Pins	Package Qty	Eco Plan (2)	Lead/Ball Finish	MSL Peak Temp (3)	Op Temp (°C)	Device Marking (4/5)	Samples
5962-9469201Q2A	ACTIVE	LCCC	FK	20	1	TBD	POST-PLATE	N / A for Pkg Type	-55 to 125	5962- 9469201Q2A TLC2262MFKB	<a href="#">Samples</a>
5962-9469201QHA	ACTIVE	CFP	U	10	1	TBD	A42	N / A for Pkg Type	-55 to 125	9469201QHA TLC2262M	<a href="#">Samples</a>
5962-9469201QPA	ACTIVE	CDIP	JG	8	1	TBD	A42	N / A for Pkg Type	-55 to 125	9469201QPA TLC2262M	<a href="#">Samples</a>
5962-9469202Q2A	ACTIVE	LCCC	FK	20	1	TBD	POST-PLATE	N / A for Pkg Type	-55 to 125	5962- 9469202Q2A TLC2264MFKB	<a href="#">Samples</a>
5962-9469202QCA	ACTIVE	CDIP	J	14	1	TBD	A42	N / A for Pkg Type	-55 to 125	5962-9469202QC A TLC2264MJB	<a href="#">Samples</a>
5962-9469202QDA	ACTIVE	CFP	W	14	1	TBD	A42	N / A for Pkg Type	-55 to 125	5962-9469202QD A TLC2264MWB	<a href="#">Samples</a>
5962-9469203Q2A	ACTIVE	LCCC	FK	20	1	TBD	POST-PLATE	N / A for Pkg Type	-55 to 125	5962- 9469203Q2A TLC2262 AMFKB	<a href="#">Samples</a>
5962-9469203QHA	ACTIVE	CFP	U	10	1	TBD	A42	N / A for Pkg Type	-55 to 125	9469203QHA TLC2262AM	<a href="#">Samples</a>
5962-9469203QPA	ACTIVE	CDIP	JG	8	1	TBD	A42	N / A for Pkg Type	-55 to 125	9469203QPA TLC2262AM	<a href="#">Samples</a>
5962-9469204Q2A	ACTIVE	LCCC	FK	20	1	TBD	POST-PLATE	N / A for Pkg Type	-55 to 125	5962- 9469204Q2A TLC2264 AMFKB	<a href="#">Samples</a>
5962-9469204QCA	ACTIVE	CDIP	J	14	1	TBD	A42	N / A for Pkg Type	-55 to 125	5962-9469204QC A TLC2264AMJB	<a href="#">Samples</a>
5962-9469204QDA	ACTIVE	CFP	W	14	1	TBD	A42	N / A for Pkg Type	-55 to 125	5962-9469204QD A TLC2264AMWB	<a href="#">Samples</a>
TLC2262AID	ACTIVE	SOIC	D	8	75	Green (RoHS & no Sb/Br)	CU NIPDAU	Level-1-260C-UNLIM	-40 to 125	2262AI	<a href="#">Samples</a>

Orderable Device	Status (1)	Package Type	Package Drawing	Pins	Package Qty	Eco Plan (2)	Lead/Ball Finish	MSL Peak Temp (3)	Op Temp (°C)	Device Marking (4/5)	Samples
TLC2262AIDG4	ACTIVE	SOIC	D	8	75	Green (RoHS & no Sb/Br)	CU NIPDAU	Level-1-260C-UNLIM	-40 to 125	2262AI	<a href="#">Samples</a>
TLC2262AIDR	ACTIVE	SOIC	D	8	2500	Green (RoHS & no Sb/Br)	CU NIPDAU	Level-1-260C-UNLIM	-40 to 125	2262AI	<a href="#">Samples</a>
TLC2262AIDRG4	ACTIVE	SOIC	D	8	2500	Green (RoHS & no Sb/Br)	CU NIPDAU	Level-1-260C-UNLIM	-40 to 125	2262AI	<a href="#">Samples</a>
TLC2262AIP	ACTIVE	PDIP	P	8	50	Pb-Free (RoHS)	CU NIPDAU	N / A for Pkg Type	-40 to 125	TLC2262AI	<a href="#">Samples</a>
TLC2262AIPE4	ACTIVE	PDIP	P	8	50	Pb-Free (RoHS)	CU NIPDAU	N / A for Pkg Type	-40 to 125	TLC2262AI	<a href="#">Samples</a>
TLC2262AIPW	ACTIVE	TSSOP	PW	8	150	Green (RoHS & no Sb/Br)	CU NIPDAU	Level-1-260C-UNLIM	-40 to 125	Y2262A	<a href="#">Samples</a>
TLC2262AIPWG4	ACTIVE	TSSOP	PW	8	150	Green (RoHS & no Sb/Br)	CU NIPDAU	Level-1-260C-UNLIM	-40 to 125	Y2262A	<a href="#">Samples</a>
TLC2262AIPWLE	OBSOLETE	TSSOP	PW	8		TBD	Call TI	Call TI	-40 to 125		
TLC2262AIPWR	ACTIVE	TSSOP	PW	8	2000	Green (RoHS & no Sb/Br)	CU NIPDAU	Level-1-260C-UNLIM	-40 to 125	Y2262A	<a href="#">Samples</a>
TLC2262AIPWRG4	ACTIVE	TSSOP	PW	8	2000	Green (RoHS & no Sb/Br)	CU NIPDAU	Level-1-260C-UNLIM	-40 to 125	Y2262A	<a href="#">Samples</a>
TLC2262AMFKB	ACTIVE	LCCC	FK	20	1	TBD	POST-PLATE	N / A for Pkg Type	-55 to 125	5962-9469203Q2A TLC2262 AMFKB	<a href="#">Samples</a>
TLC2262AMJG	ACTIVE	CDIP	JG	8	1	TBD	A42	N / A for Pkg Type	-55 to 125	TLC2262 AMJG	<a href="#">Samples</a>
TLC2262AMJGB	ACTIVE	CDIP	JG	8	1	TBD	A42	N / A for Pkg Type	-55 to 125	9469203QPA TLC2262AM	<a href="#">Samples</a>
TLC2262AMUB	ACTIVE	CFP	U	10	1	TBD	A42	N / A for Pkg Type	-55 to 125	9469203QHA TLC2262AM	<a href="#">Samples</a>
TLC2262AQD	ACTIVE	SOIC	D	8	75	Green (RoHS & no Sb/Br)	CU NIPDAU	Level-1-260C-UNLIM	-40 to 125	C2262A	<a href="#">Samples</a>
TLC2262AQDG4	ACTIVE	SOIC	D	8	75	Green (RoHS & no Sb/Br)	CU NIPDAU	Level-1-260C-UNLIM		C2262A	<a href="#">Samples</a>
TLC2262AQDR	OBSOLETE	SOIC	D	8		TBD	Call TI	Call TI	-40 to 125	C2262A	
TLC2262AQDRG4	ACTIVE	SOIC	D	8	2500	Green (RoHS & no Sb/Br)	CU NIPDAU	Level-1-260C-UNLIM		C2262A	<a href="#">Samples</a>

Orderable Device	Status (1)	Package Type	Package Drawing	Pins	Package Qty	Eco Plan (2)	Lead/Ball Finish	MSL Peak Temp (3)	Op Temp (°C)	Device Marking (4/5)	Samples
TLC2262CD	ACTIVE	SOIC	D	8	75	Green (RoHS & no Sb/Br)	CU NIPDAU	Level-1-260C-UNLIM	0 to 70	2262C	<a href="#">Samples</a>
TLC2262CDG4	ACTIVE	SOIC	D	8	75	Green (RoHS & no Sb/Br)	CU NIPDAU	Level-1-260C-UNLIM	0 to 70	2262C	<a href="#">Samples</a>
TLC2262CDR	ACTIVE	SOIC	D	8	2500	Green (RoHS & no Sb/Br)	CU NIPDAU	Level-1-260C-UNLIM	0 to 70	2262C	<a href="#">Samples</a>
TLC2262CDRG4	ACTIVE	SOIC	D	8	2500	Green (RoHS & no Sb/Br)	CU NIPDAU	Level-1-260C-UNLIM	0 to 70	2262C	<a href="#">Samples</a>
TLC2262CP	ACTIVE	PDIP	P	8	50	Pb-Free (RoHS)	CU NIPDAU	N / A for Pkg Type	0 to 70	TLC2262CP	<a href="#">Samples</a>
TLC2262CPE4	ACTIVE	PDIP	P	8	50	Pb-Free (RoHS)	CU NIPDAU	N / A for Pkg Type	0 to 70	TLC2262CP	<a href="#">Samples</a>
TLC2262CPW	ACTIVE	TSSOP	PW	8	150	Green (RoHS & no Sb/Br)	CU NIPDAU	Level-1-260C-UNLIM	0 to 70	P2262	<a href="#">Samples</a>
TLC2262CPWG4	ACTIVE	TSSOP	PW	8	150	Green (RoHS & no Sb/Br)	CU NIPDAU	Level-1-260C-UNLIM	0 to 70	P2262	<a href="#">Samples</a>
TLC2262CPWLE	OBSOLETE	TSSOP	PW	8		TBD	Call TI	Call TI	0 to 70		
TLC2262CPWR	ACTIVE	TSSOP	PW	8	2000	Green (RoHS & no Sb/Br)	CU NIPDAU	Level-1-260C-UNLIM	0 to 70	P2262	<a href="#">Samples</a>
TLC2262CPWRG4	ACTIVE	TSSOP	PW	8	2000	Green (RoHS & no Sb/Br)	CU NIPDAU	Level-1-260C-UNLIM	0 to 70	P2262	<a href="#">Samples</a>
TLC2262ID	ACTIVE	SOIC	D	8	75	Green (RoHS & no Sb/Br)	CU NIPDAU	Level-1-260C-UNLIM		2262I	<a href="#">Samples</a>
TLC2262IDG4	ACTIVE	SOIC	D	8	75	Green (RoHS & no Sb/Br)	CU NIPDAU	Level-1-260C-UNLIM		2262I	<a href="#">Samples</a>
TLC2262IDR	ACTIVE	SOIC	D	8	2500	Green (RoHS & no Sb/Br)	CU NIPDAU	Level-1-260C-UNLIM		2262I	<a href="#">Samples</a>
TLC2262IDRG4	ACTIVE	SOIC	D	8	2500	Green (RoHS & no Sb/Br)	CU NIPDAU	Level-1-260C-UNLIM		2262I	<a href="#">Samples</a>
TLC2262IP	ACTIVE	PDIP	P	8	50	Pb-Free (RoHS)	CU NIPDAU	N / A for Pkg Type		TLC2262IP	<a href="#">Samples</a>
TLC2262IPE4	ACTIVE	PDIP	P	8	50	Pb-Free (RoHS)	CU NIPDAU	N / A for Pkg Type		TLC2262IP	<a href="#">Samples</a>
TLC2262MFKB	ACTIVE	LCCC	FK	20	1	TBD	POST-PLATE	N / A for Pkg Type	-55 to 125	5962- 9469201Q2A TLC2262MFKB	<a href="#">Samples</a>

Orderable Device	Status (1)	Package Type	Package Drawing	Pins	Package Qty	Eco Plan (2)	Lead/Ball Finish	MSL Peak Temp (3)	Op Temp (°C)	Device Marking (4/5)	Samples
TLC2262MJGB	ACTIVE	CDIP	JG	8	1	TBD	A42	N / A for Pkg Type	-55 to 125	9469201QPA TLC2262M	<a href="#">Samples</a>
TLC2262MUB	ACTIVE	CFP	U	10	1	TBD	A42	N / A for Pkg Type	-55 to 125	9469201QHA TLC2262M	<a href="#">Samples</a>
TLC2262QD	ACTIVE	SOIC	D	8	75	Green (RoHS & no Sb/Br)	CU NIPDAU	Level-1-260C-UNLIM	-40 to 125	C2262Q	<a href="#">Samples</a>
TLC2262QDG4	ACTIVE	SOIC	D	8	1500	Green (RoHS & no Sb/Br)	CU NIPDAU	Level-1-260C-UNLIM		C2262Q	<a href="#">Samples</a>
TLC2262QDR	ACTIVE	SOIC	D	8	2500	Green (RoHS & no Sb/Br)	CU NIPDAU	Level-1-260C-UNLIM	-40 to 125	C2262Q	<a href="#">Samples</a>
TLC2262QDRG4	ACTIVE	SOIC	D	8	2500	Green (RoHS & no Sb/Br)	CU NIPDAU	Level-1-260C-UNLIM		C2262Q	<a href="#">Samples</a>
TLC2264AID	ACTIVE	SOIC	D	14	50	Green (RoHS & no Sb/Br)	CU NIPDAU	Level-1-260C-UNLIM	-40 to 125	2264AI	<a href="#">Samples</a>
TLC2264AIDG4	ACTIVE	SOIC	D	14	50	Green (RoHS & no Sb/Br)	CU NIPDAU	Level-1-260C-UNLIM	-40 to 125	2264AI	<a href="#">Samples</a>
TLC2264AIDR	ACTIVE	SOIC	D	14	2500	Green (RoHS & no Sb/Br)	CU NIPDAU	Level-1-260C-UNLIM	-40 to 125	2264AI	<a href="#">Samples</a>
TLC2264AIDRG4	ACTIVE	SOIC	D	14	2500	Green (RoHS & no Sb/Br)	CU NIPDAU	Level-1-260C-UNLIM	-40 to 125	2264AI	<a href="#">Samples</a>
TLC2264AIN	ACTIVE	PDIP	N	14	25	Pb-Free (RoHS)	CU NIPDAU	N / A for Pkg Type	-40 to 125	TLC2264AIN	<a href="#">Samples</a>
TLC2264AINE4	ACTIVE	PDIP	N	14	25	Pb-Free (RoHS)	CU NIPDAU	N / A for Pkg Type	-40 to 125	TLC2264AIN	<a href="#">Samples</a>
TLC2264AIPW	ACTIVE	TSSOP	PW	14	90	Green (RoHS & no Sb/Br)	CU NIPDAU	Level-1-260C-UNLIM	-40 to 125	Y2264A	<a href="#">Samples</a>
TLC2264AIPWG4	ACTIVE	TSSOP	PW	14	90	Green (RoHS & no Sb/Br)	CU NIPDAU	Level-1-260C-UNLIM	-40 to 125	Y2264A	<a href="#">Samples</a>
TLC2264AIPWLE	OBSOLETE	TSSOP	PW	14		TBD	Call TI	Call TI	-40 to 125		
TLC2264AIPWR	ACTIVE	TSSOP	PW	14	2000	Green (RoHS & no Sb/Br)	CU NIPDAU	Level-1-260C-UNLIM	-40 to 125	Y2264A	<a href="#">Samples</a>
TLC2264AIPWRG4	ACTIVE	TSSOP	PW	14	2000	Green (RoHS & no Sb/Br)	CU NIPDAU	Level-1-260C-UNLIM	-40 to 125	Y2264A	<a href="#">Samples</a>
TLC2264AMFKB	ACTIVE	LCCC	FK	20	1	TBD	POST-PLATE	N / A for Pkg Type	-55 to 125	5962- 9469204Q2A TLC2264	<a href="#">Samples</a>

Orderable Device	Status (1)	Package Type	Package Drawing	Pins	Package Qty	Eco Plan (2)	Lead/Ball Finish	MSL Peak Temp (3)	Op Temp (°C)	Device Marking (4/5)	Samples
										AMFKB	
TLC2264AMJ	ACTIVE	CDIP	J	14	1	TBD	A42	N / A for Pkg Type	-55 to 125	TLC2264AMJ	<a href="#">Samples</a>
TLC2264AMJB	ACTIVE	CDIP	J	14	1	TBD	A42	N / A for Pkg Type	-55 to 125	5962-9469204QC A TLC2264AMJB	<a href="#">Samples</a>
TLC2264AMWB	ACTIVE	CFP	W	14	1	TBD	A42	N / A for Pkg Type	-55 to 125	5962-9469204QD A TLC2264AMWB	<a href="#">Samples</a>
TLC2264AQD	ACTIVE	SOIC	D	14	50	Green (RoHS & no Sb/Br)	CU NIPDAU	Level-1-260C-UNLIM	-40 to 125	2264AQ	<a href="#">Samples</a>
TLC2264AQDG4	ACTIVE	SOIC	D	14	50	Green (RoHS & no Sb/Br)	CU NIPDAU	Level-1-260C-UNLIM		2264AQ	<a href="#">Samples</a>
TLC2264AQDR	OBSOLETE	SOIC	D	14		TBD	Call TI	Call TI	-40 to 125	TLC2264A	
TLC2264AQDRG4	ACTIVE	SOIC	D	14	2500	Green (RoHS & no Sb/Br)	CU NIPDAU	Level-1-260C-UNLIM		PJ2264A	<a href="#">Samples</a>
TLC2264CD	ACTIVE	SOIC	D	14	50	Green (RoHS & no Sb/Br)	CU NIPDAU	Level-1-260C-UNLIM	0 to 70	TLC2264C	<a href="#">Samples</a>
TLC2264CDG4	ACTIVE	SOIC	D	14	50	Green (RoHS & no Sb/Br)	CU NIPDAU	Level-1-260C-UNLIM	0 to 70	TLC2264C	<a href="#">Samples</a>
TLC2264CDR	ACTIVE	SOIC	D	14	2500	Green (RoHS & no Sb/Br)	CU NIPDAU	Level-1-260C-UNLIM	0 to 70	TLC2264C	<a href="#">Samples</a>
TLC2264CDRG4	ACTIVE	SOIC	D	14	2500	Green (RoHS & no Sb/Br)	CU NIPDAU	Level-1-260C-UNLIM	0 to 70	TLC2264C	<a href="#">Samples</a>
TLC2264CN	ACTIVE	PDIP	N	14	25	Pb-Free (RoHS)	CU NIPDAU	N / A for Pkg Type	0 to 70	TLC2264CN	<a href="#">Samples</a>
TLC2264CNE4	ACTIVE	PDIP	N	14	25	Pb-Free (RoHS)	CU NIPDAU	N / A for Pkg Type	0 to 70	TLC2264CN	<a href="#">Samples</a>
TLC2264CPW	ACTIVE	TSSOP	PW	14	90	Green (RoHS & no Sb/Br)	CU NIPDAU	Level-1-260C-UNLIM	0 to 70	P2264	<a href="#">Samples</a>
TLC2264CPWG4	ACTIVE	TSSOP	PW	14	90	Green (RoHS & no Sb/Br)	CU NIPDAU	Level-1-260C-UNLIM	0 to 70	P2264	<a href="#">Samples</a>
TLC2264CPWLE	OBSOLETE	TSSOP	PW	14		TBD	Call TI	Call TI	0 to 70		
TLC2264CPWR	ACTIVE	TSSOP	PW	14	2000	Green (RoHS & no Sb/Br)	CU NIPDAU	Level-1-260C-UNLIM	0 to 70	P2264	<a href="#">Samples</a>
TLC2264CPWRG4	ACTIVE	TSSOP	PW	14	2000	Green (RoHS & no Sb/Br)	CU NIPDAU	Level-1-260C-UNLIM	0 to 70	P2264	<a href="#">Samples</a>

Orderable Device	Status (1)	Package Type	Package Drawing	Pins	Package Qty	Eco Plan (2)	Lead/Ball Finish	MSL Peak Temp (3)	Op Temp (°C)	Device Marking (4/5)	Samples
TLC2264ID	ACTIVE	SOIC	D	14	50	Green (RoHS & no Sb/Br)	CU NIPDAU	Level-1-260C-UNLIM		TLC2264I	<a href="#">Samples</a>
TLC2264IDG4	ACTIVE	SOIC	D	14	50	Green (RoHS & no Sb/Br)	CU NIPDAU	Level-1-260C-UNLIM		TLC2264I	<a href="#">Samples</a>
TLC2264IDR	ACTIVE	SOIC	D	14	2500	Green (RoHS & no Sb/Br)	CU NIPDAU	Level-1-260C-UNLIM		TLC2264I	<a href="#">Samples</a>
TLC2264IDRG4	ACTIVE	SOIC	D	14	2500	Green (RoHS & no Sb/Br)	CU NIPDAU	Level-1-260C-UNLIM		TLC2264I	<a href="#">Samples</a>
TLC2264IN	ACTIVE	PDIP	N	14	25	Pb-Free (RoHS)	CU NIPDAU	N / A for Pkg Type		TLC2264IN	<a href="#">Samples</a>
TLC2264INE4	ACTIVE	PDIP	N	14	25	Pb-Free (RoHS)	CU NIPDAU	N / A for Pkg Type		TLC2264IN	<a href="#">Samples</a>
TLC2264MFKB	ACTIVE	LCCC	FK	20	1	TBD	POST-PLATE	N / A for Pkg Type	-55 to 125	5962-9469202Q2A TLC2264MFKB	<a href="#">Samples</a>
TLC2264MJB	ACTIVE	CDIP	J	14	1	TBD	A42	N / A for Pkg Type	-55 to 125	5962-9469202QC A TLC2264MJB	<a href="#">Samples</a>
TLC2264MWB	ACTIVE	CFP	W	14	1	TBD	A42	N / A for Pkg Type	-55 to 125	5962-9469202QD A TLC2264MWB	<a href="#">Samples</a>
TLC2264QD	OBSOLETE	SOIC	D	14		TBD	Call TI	Call TI	-40 to 125	TLC2264	
TLC2264QDG4	ACTIVE	SOIC	D	14	50	Green (RoHS & no Sb/Br)	CU NIPDAU	Level-1-260C-UNLIM		TLC2264	<a href="#">Samples</a>
TLC2264QDR	OBSOLETE	SOIC	D	14		TBD	Call TI	Call TI	-40 to 125	TLC2264	
TLC2264QDRG4	ACTIVE	SOIC	D	14	1500	Green (RoHS & no Sb/Br)	CU NIPDAU	Level-1-260C-UNLIM		TLC2264	<a href="#">Samples</a>

(1) The marketing status values are defined as follows:

**ACTIVE:** Product device recommended for new designs.

**LIFEBUY:** TI has announced that the device will be discontinued, and a lifetime-buy period is in effect.

**NRND:** Not recommended for new designs. Device is in production to support existing customers, but TI does not recommend using this part in a new design.

**PREVIEW:** Device has been announced but is not in production. Samples may or may not be available.

**OBSOLETE:** TI has discontinued the production of the device.

(2) Eco Plan - The planned eco-friendly classification: Pb-Free (RoHS), Pb-Free (RoHS Exempt), or Green (RoHS & no Sb/Br) - please check <http://www.ti.com/productcontent> for the latest availability information and additional product content details.

**TBD:** The Pb-Free/Green conversion plan has not been defined.

**Pb-Free (RoHS):** TI's terms "Lead-Free" or "Pb-Free" mean semiconductor products that are compatible with the current RoHS requirements for all 6 substances, including the requirement that lead not exceed 0.1% by weight in homogeneous materials. Where designed to be soldered at high temperatures, TI Pb-Free products are suitable for use in specified lead-free processes.

**Pb-Free (RoHS Exempt):** This component has a RoHS exemption for either 1) lead-based flip-chip solder bumps used between the die and package, or 2) lead-based die adhesive used between the die and leadframe. The component is otherwise considered Pb-Free (RoHS compatible) as defined above.

**Green (RoHS & no Sb/Br):** TI defines "Green" to mean Pb-Free (RoHS compatible), and free of Bromine (Br) and Antimony (Sb) based flame retardants (Br or Sb do not exceed 0.1% by weight in homogeneous material)

<sup>(3)</sup> MSL, Peak Temp. -- The Moisture Sensitivity Level rating according to the JEDEC industry standard classifications, and peak solder temperature.

<sup>(4)</sup> There may be additional marking, which relates to the logo, the lot trace code information, or the environmental category on the device.

<sup>(5)</sup> Multiple Device Markings will be inside parentheses. Only one Device Marking contained in parentheses and separated by a "~" will appear on a device. If a line is indented then it is a continuation of the previous line and the two combined represent the entire Device Marking for that device.

**Important Information and Disclaimer:** The information provided on this page represents TI's knowledge and belief as of the date that it is provided. TI bases its knowledge and belief on information provided by third parties, and makes no representation or warranty as to the accuracy of such information. Efforts are underway to better integrate information from third parties. TI has taken and continues to take reasonable steps to provide representative and accurate information but may not have conducted destructive testing or chemical analysis on incoming materials and chemicals. TI and TI suppliers consider certain information to be proprietary, and thus CAS numbers and other limited information may not be available for release.

In no event shall TI's liability arising out of such information exceed the total purchase price of the TI part(s) at issue in this document sold by TI to Customer on an annual basis.

**OTHER QUALIFIED VERSIONS OF TLC2262, TLC2262A, TLC2262AM, TLC2262M, TLC2264, TLC2264A, TLC2264AM, TLC2264M :**

- Catalog: [TLC2262A](#), [TLC2262](#), [TLC2264A](#), [TLC2264](#)
- Automotive: [TLC2264A-Q1](#), [TLC2264A-Q1](#)
- Military: [TLC2262M](#), [TLC2262AM](#), [TLC2264M](#), [TLC2264AM](#)

NOTE: Qualified Version Definitions:

- Catalog - TI's standard catalog product
- Automotive - Q100 devices qualified for high-reliability automotive applications targeting zero defects
- Military - QML certified for Military and Defense Applications



**TAPE AND REEL INFORMATION**

**QUADRANT ASSIGNMENTS FOR PIN 1 ORIENTATION IN TAPE**

\*All dimensions are nominal

Device	Package Type	Package Drawing	Pins	SPQ	Reel Diameter (mm)	Reel Width W1 (mm)	A0 (mm)	B0 (mm)	K0 (mm)	P1 (mm)	W (mm)	Pin1 Quadrant
TLC2262AIDR	SOIC	D	8	2500	330.0	12.4	6.4	5.2	2.1	8.0	12.0	Q1
TLC2262CDR	SOIC	D	8	2500	330.0	12.4	6.4	5.2	2.1	8.0	12.0	Q1
TLC2262CPWR	TSSOP	PW	8	2000	330.0	12.4	7.0	3.6	1.6	8.0	12.0	Q1
TLC2262IDR	SOIC	D	8	2500	330.0	12.4	6.4	5.2	2.1	8.0	12.0	Q1
TLC2264AIDR	SOIC	D	14	2500	330.0	16.4	6.5	9.0	2.1	8.0	16.0	Q1
TLC2264AIPWR	TSSOP	PW	14	2000	330.0	12.4	6.9	5.6	1.6	8.0	12.0	Q1
TLC2264CDR	SOIC	D	14	2500	330.0	16.4	6.5	9.0	2.1	8.0	16.0	Q1
TLC2264CPWR	TSSOP	PW	14	2000	330.0	12.4	6.9	5.6	1.6	8.0	12.0	Q1
TLC2264IDR	SOIC	D	14	2500	330.0	16.4	6.5	9.0	2.1	8.0	16.0	Q1

**TAPE AND REEL BOX DIMENSIONS**

\*All dimensions are nominal

Device	Package Type	Package Drawing	Pins	SPQ	Length (mm)	Width (mm)	Height (mm)
TLC2262AIDR	SOIC	D	8	2500	340.5	338.1	20.6
TLC2262CDR	SOIC	D	8	2500	340.5	338.1	20.6
TLC2262CPWR	TSSOP	PW	8	2000	367.0	367.0	35.0
TLC2262IDR	SOIC	D	8	2500	340.5	338.1	20.6
TLC2264AIDR	SOIC	D	14	2500	333.2	345.9	28.6
TLC2264AIPWR	TSSOP	PW	14	2000	367.0	367.0	35.0
TLC2264CDR	SOIC	D	14	2500	333.2	345.9	28.6
TLC2264CPWR	TSSOP	PW	14	2000	367.0	367.0	35.0
TLC2264IDR	SOIC	D	14	2500	333.2	345.9	28.6

JG (R-GDIP-T8)

CERAMIC DUAL-IN-LINE



- NOTES: A. All linear dimensions are in inches (millimeters).  
 B. This drawing is subject to change without notice.  
 C. This package can be hermetically sealed with a ceramic lid using glass frit.  
 D. Index point is provided on cap for terminal identification.  
 E. Falls within MIL STD 1835 GDIP1-T8

J (R-GDIP-T\*\*)

14 LEADS SHOWN

CERAMIC DUAL IN-LINE PACKAGE



DIM \ PINS **	14	16	18	20
A	0.300 (7,62) BSC	0.300 (7,62) BSC	0.300 (7,62) BSC	0.300 (7,62) BSC
B MAX	0.785 (19,94)	.840 (21,34)	0.960 (24,38)	1.060 (26,92)
B MIN	—	—	—	—
C MAX	0.300 (7,62)	0.300 (7,62)	0.310 (7,87)	0.300 (7,62)
C MIN	0.245 (6,22)	0.245 (6,22)	0.220 (5,59)	0.245 (6,22)



4040083/F 03/03

- NOTES:
- All linear dimensions are in inches (millimeters).
  - This drawing is subject to change without notice.
  - This package is hermetically sealed with a ceramic lid using glass frit.
  - Index point is provided on cap for terminal identification only on press ceramic glass frit seal only.
  - Falls within MIL STD 1835 GDIP1-T14, GDIP1-T16, GDIP1-T18 and GDIP1-T20.

U (S-GDFP-F10)

CERAMIC DUAL FLATPACK

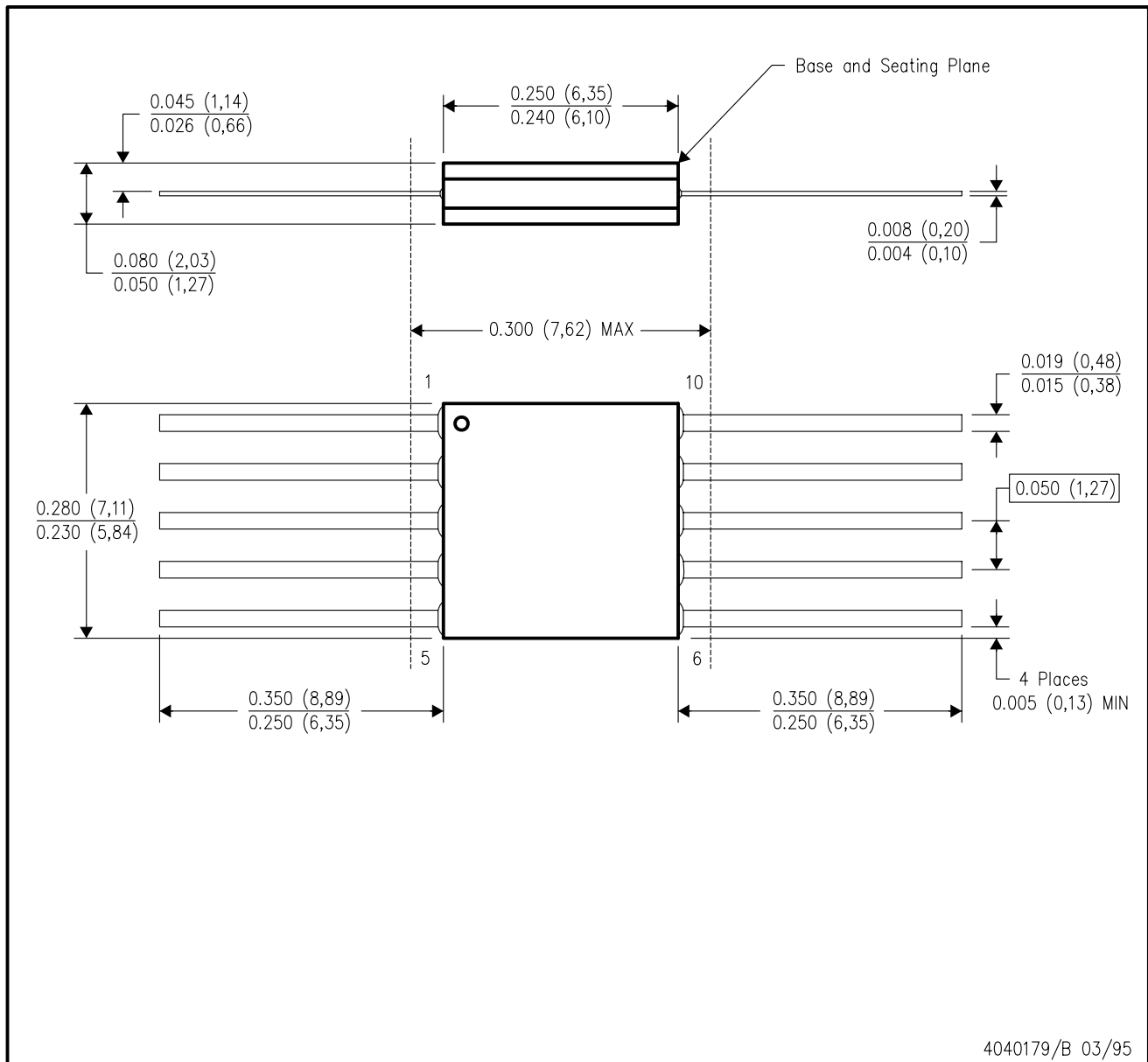

- NOTES:
- A. All linear dimensions are in inches (millimeters).
  - B. This drawing is subject to change without notice.
  - C. This package can be hermetically sealed with a ceramic lid using glass frit.
  - D. Index point is provided on cap for terminal identification only.
  - E. Falls within MIL STD 1835 GDFP1-F10 and JEDEC MO-092AA

W (R-GDFP-F14)

CERAMIC DUAL FLATPACK



- NOTES:
- A. All linear dimensions are in inches (millimeters).
  - B. This drawing is subject to change without notice.
  - C. This package can be hermetically sealed with a ceramic lid using glass frit.
  - D. Index point is provided on cap for terminal identification only.
  - E. Falls within MIL STD 1835 GDFP1-F14 and JEDEC MO-092AB

FK (S-CQCC-N\*\*)

LEADLESS CERAMIC CHIP CARRIER

28 TERMINAL SHOWN



NO. OF TERMINALS **	A		B	
	MIN	MAX	MIN	MAX
20	0.342 (8,69)	0.358 (9,09)	0.307 (7,80)	0.358 (9,09)
28	0.442 (11,23)	0.458 (11,63)	0.406 (10,31)	0.458 (11,63)
44	0.640 (16,26)	0.660 (16,76)	0.495 (12,58)	0.560 (14,22)
52	0.740 (18,78)	0.761 (19,32)	0.495 (12,58)	0.560 (14,22)
68	0.938 (23,83)	0.962 (24,43)	0.850 (21,6)	0.858 (21,8)
84	1.141 (28,99)	1.165 (29,59)	1.047 (26,6)	1.063 (27,0)



4040140/D 01/11

- NOTES:
- All linear dimensions are in inches (millimeters).
  - This drawing is subject to change without notice.
  - This package can be hermetically sealed with a metal lid.
  - Falls within JEDEC MS-004

P (R-PDIP-T8)

PLASTIC DUAL-IN-LINE PACKAGE



- NOTES:
- A. All linear dimensions are in inches (millimeters).
  - B. This drawing is subject to change without notice.
  - C. Falls within JEDEC MS-001 variation BA.



N (R-PDIP-T\*\*)

PLASTIC DUAL-IN-LINE PACKAGE

16 PINS SHOWN



- NOTES:
- A. All linear dimensions are in inches (millimeters).
  - B. This drawing is subject to change without notice.
  - Falls within JEDEC MS-001, except 18 and 20 pin minimum body length (Dim A).
  - The 20 pin end lead shoulder width is a vendor option, either half or full width.

D (R-PDSO-G14)

PLASTIC SMALL OUTLINE



- NOTES:
- A. All linear dimensions are in inches (millimeters).
  - B. This drawing is subject to change without notice.
  - Body length does not include mold flash, protrusions, or gate burrs. Mold flash, protrusions, or gate burrs shall not exceed 0.006 (0,15) each side.
  - Body width does not include interlead flash. Interlead flash shall not exceed 0.017 (0,43) each side.
  - E. Reference JEDEC MS-012 variation AB.

D (R-PDSO-G14)

PLASTIC SMALL OUTLINE



- NOTES:
- All linear dimensions are in millimeters.
  - This drawing is subject to change without notice.
  - Publication IPC-7351 is recommended for alternate designs.
  - Laser cutting apertures with trapezoidal walls and also rounding corners will offer better paste release. Customers should contact their board assembly site for stencil design recommendations. Refer to IPC-7525 for other stencil recommendations.
  - Customers should contact their board fabrication site for solder mask tolerances between and around signal pads.

# MECHANICAL DATA

PW (R-PDSO-G14)

PLASTIC SMALL OUTLINE



4040064-3/G 02/11

- NOTES:
- A. All linear dimensions are in millimeters. Dimensioning and tolerancing per ASME Y14.5M-1994.
  - B. This drawing is subject to change without notice.
  - C. Body length does not include mold flash, protrusions, or gate burrs. Mold flash, protrusions, or gate burrs shall not exceed 0,15 each side.
  - D. Body width does not include interlead flash. Interlead flash shall not exceed 0,25 each side.
  - E. Falls within JEDEC MO-153

PW (R-PDSO-G14)

PLASTIC SMALL OUTLINE

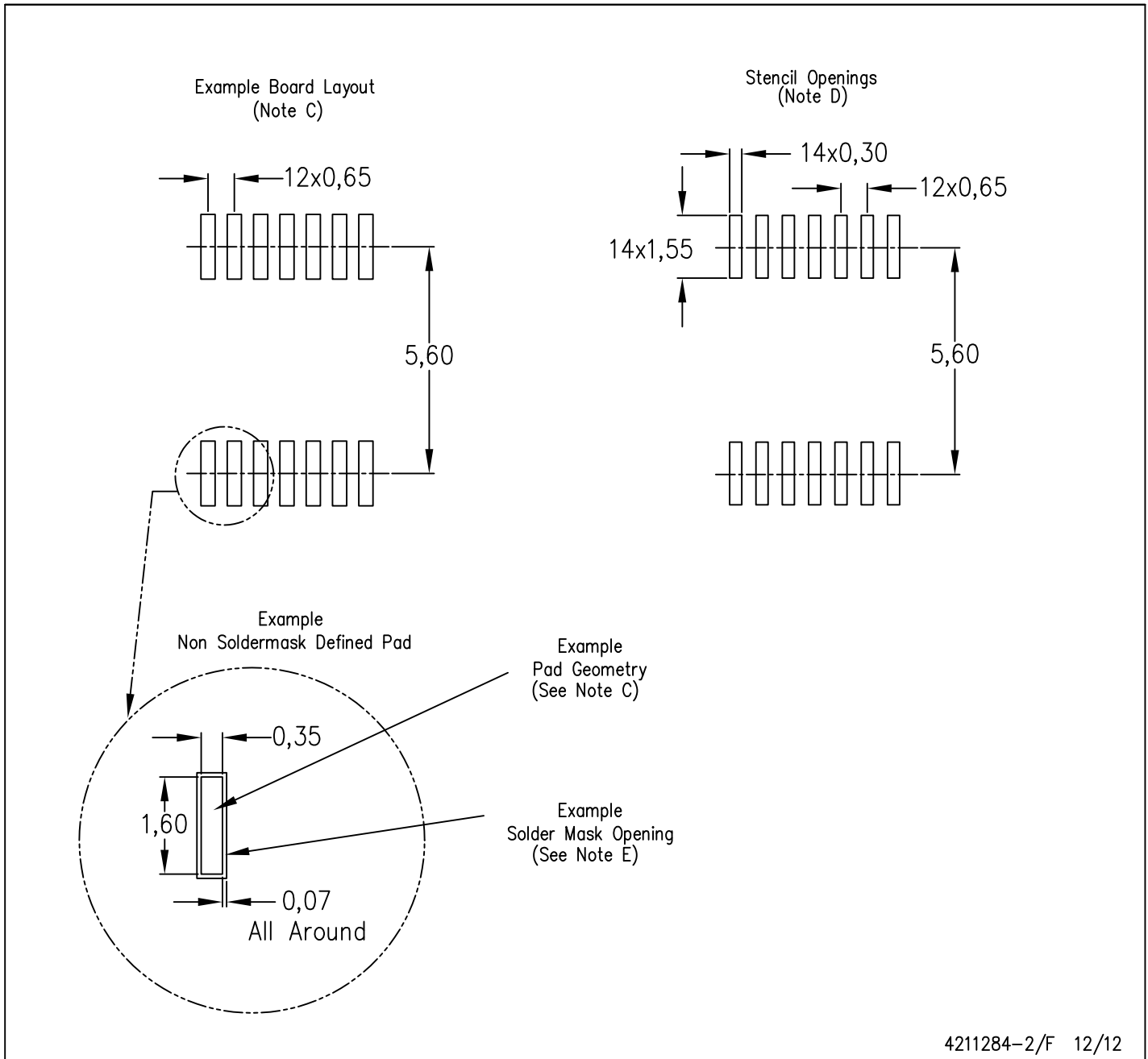

- NOTES:
- All linear dimensions are in millimeters.
  - This drawing is subject to change without notice.
  - Publication IPC-7351 is recommended for alternate designs.
  - Laser cutting apertures with trapezoidal walls and also rounding corners will offer better paste release. Customers should contact their board assembly site for stencil design recommendations. Refer to IPC-7525 for other stencil recommendations.
  - Customers should contact their board fabrication site for solder mask tolerances between and around signal pads.

D (R-PDSO-G8)

PLASTIC SMALL OUTLINE

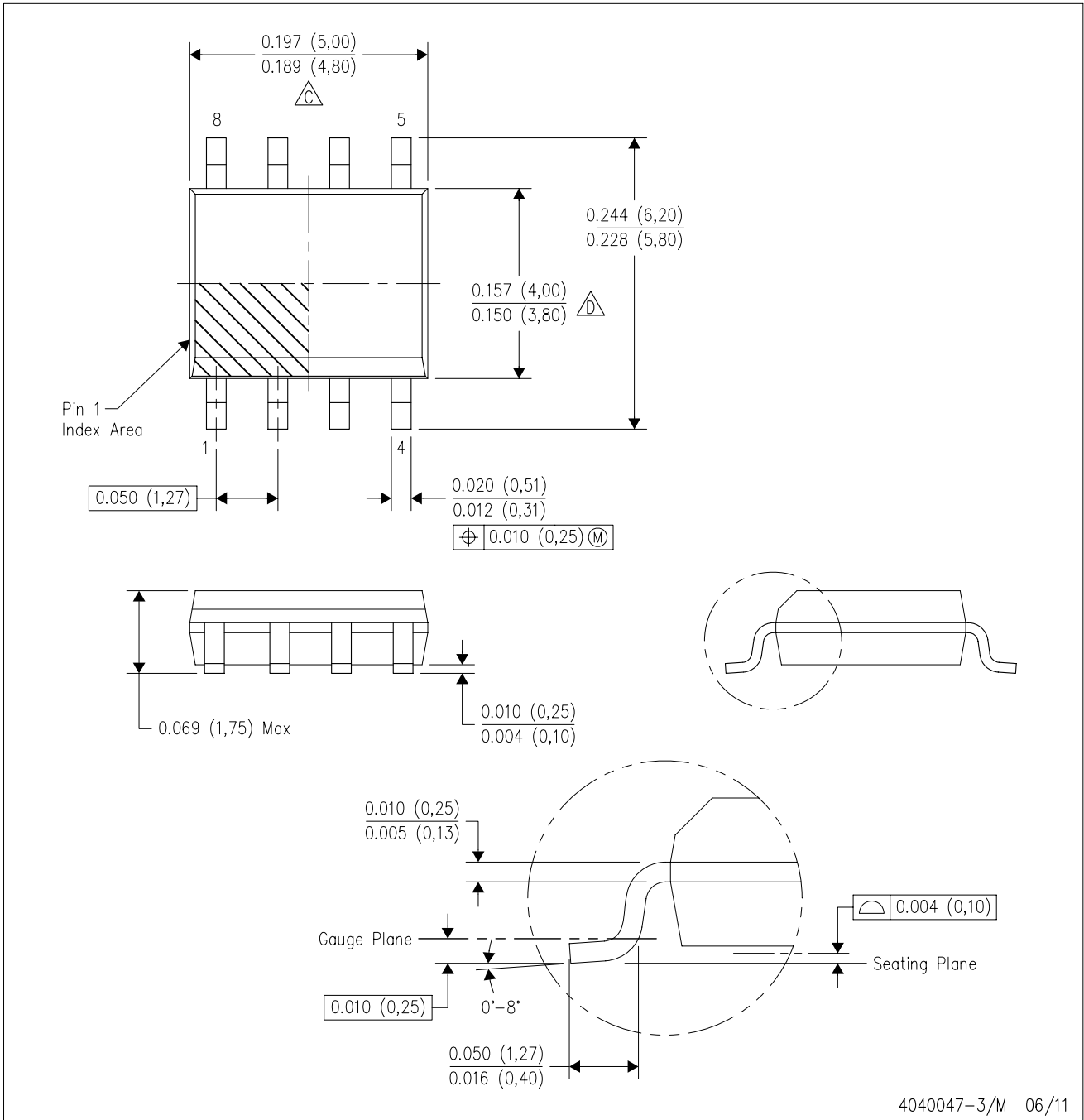

4040047-3/M 06/11

- NOTES:
- A. All linear dimensions are in inches (millimeters).
  - B. This drawing is subject to change without notice.
  - $\triangle C$  Body length does not include mold flash, protrusions, or gate burrs. Mold flash, protrusions, or gate burrs shall not exceed 0.006 (0,15) each side.
  - $\triangle D$  Body width does not include interlead flash. Interlead flash shall not exceed 0.017 (0,43) each side.
  - E. Reference JEDEC MS-012 variation AA.

D (R-PDSO-G8)

PLASTIC SMALL OUTLINE



4211283-2/E 08/12

- NOTES:
- A. All linear dimensions are in millimeters.
  - B. This drawing is subject to change without notice.
  - C. Publication IPC-7351 is recommended for alternate designs.
  - D. Laser cutting apertures with trapezoidal walls and also rounding corners will offer better paste release. Customers should contact their board assembly site for stencil design recommendations. Refer to IPC-7525 for other stencil recommendations.
  - E. Customers should contact their board fabrication site for solder mask tolerances between and around signal pads.

PW (R-PDSO-G8)

PLASTIC SMALL OUTLINE

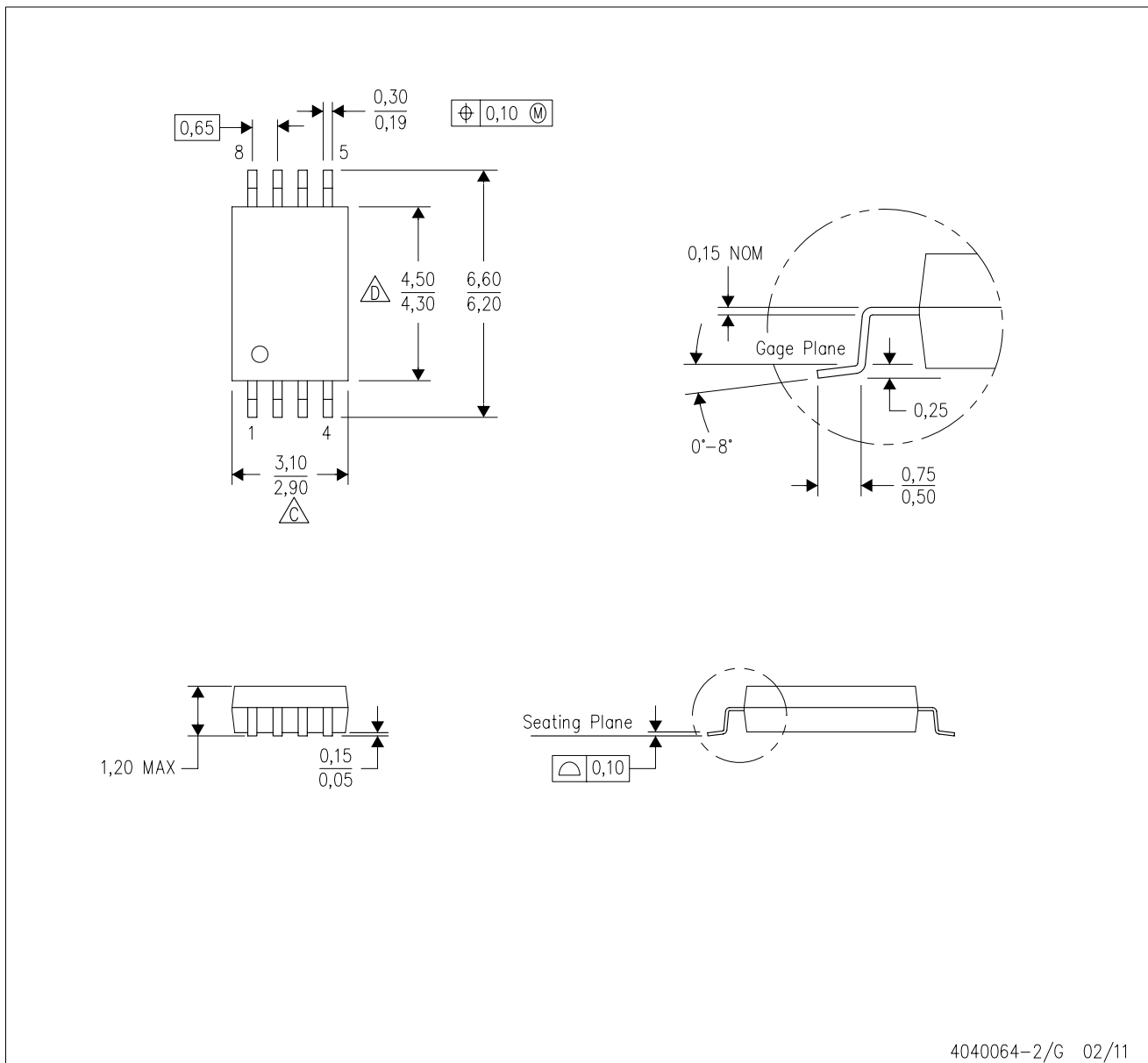

- NOTES:
- A. All linear dimensions are in millimeters. Dimensioning and tolerancing per ASME Y14.5M-1994.
  - B. This drawing is subject to change without notice.
  - C. Body length does not include mold flash, protrusions, or gate burrs. Mold flash, protrusions, or gate burrs shall not exceed 0,15 each side.
  - D. Body width does not include interlead flash. Interlead flash shall not exceed 0,25 each side.
  - E. Falls within JEDEC MO-153



## IMPORTANT NOTICE

Texas Instruments Incorporated and its subsidiaries (TI) reserve the right to make corrections, enhancements, improvements and other changes to its semiconductor products and services per JESD46, latest issue, and to discontinue any product or service per JESD48, latest issue. Buyers should obtain the latest relevant information before placing orders and should verify that such information is current and complete. All semiconductor products (also referred to herein as "components") are sold subject to TI's terms and conditions of sale supplied at the time of order acknowledgment.

TI warrants performance of its components to the specifications applicable at the time of sale, in accordance with the warranty in TI's terms and conditions of sale of semiconductor products. Testing and other quality control techniques are used to the extent TI deems necessary to support this warranty. Except where mandated by applicable law, testing of all parameters of each component is not necessarily performed.

TI assumes no liability for applications assistance or the design of Buyers' products. Buyers are responsible for their products and applications using TI components. To minimize the risks associated with Buyers' products and applications, Buyers should provide adequate design and operating safeguards.

TI does not warrant or represent that any license, either express or implied, is granted under any patent right, copyright, mask work right, or other intellectual property right relating to any combination, machine, or process in which TI components or services are used. Information published by TI regarding third-party products or services does not constitute a license to use such products or services or a warranty or endorsement thereof. Use of such information may require a license from a third party under the patents or other intellectual property of the third party, or a license from TI under the patents or other intellectual property of TI.

Reproduction of significant portions of TI information in TI data books or data sheets is permissible only if reproduction is without alteration and is accompanied by all associated warranties, conditions, limitations, and notices. TI is not responsible or liable for such altered documentation. Information of third parties may be subject to additional restrictions.

Resale of TI components or services with statements different from or beyond the parameters stated by TI for that component or service voids all express and any implied warranties for the associated TI component or service and is an unfair and deceptive business practice. TI is not responsible or liable for any such statements.

Buyer acknowledges and agrees that it is solely responsible for compliance with all legal, regulatory and safety-related requirements concerning its products, and any use of TI components in its applications, notwithstanding any applications-related information or support that may be provided by TI. Buyer represents and agrees that it has all the necessary expertise to create and implement safeguards which anticipate dangerous consequences of failures, monitor failures and their consequences, lessen the likelihood of failures that might cause harm and take appropriate remedial actions. Buyer will fully indemnify TI and its representatives against any damages arising out of the use of any TI components in safety-critical applications.

In some cases, TI components may be promoted specifically to facilitate safety-related applications. With such components, TI's goal is to help enable customers to design and create their own end-product solutions that meet applicable functional safety standards and requirements. Nonetheless, such components are subject to these terms.

No TI components are authorized for use in FDA Class III (or similar life-critical medical equipment) unless authorized officers of the parties have executed a special agreement specifically governing such use.

Only those TI components which TI has specifically designated as military grade or "enhanced plastic" are designed and intended for use in military/aerospace applications or environments. Buyer acknowledges and agrees that any military or aerospace use of TI components which have **not** been so designated is solely at the Buyer's risk, and that Buyer is solely responsible for compliance with all legal and regulatory requirements in connection with such use.

TI has specifically designated certain components as meeting ISO/TS16949 requirements, mainly for automotive use. In any case of use of non-designated products, TI will not be responsible for any failure to meet ISO/TS16949.

### Products

Audio	<a href="http://www.ti.com/audio">www.ti.com/audio</a>
Amplifiers	<a href="http://amplifier.ti.com">amplifier.ti.com</a>
Data Converters	<a href="http://dataconverter.ti.com">dataconverter.ti.com</a>
DLP® Products	<a href="http://www.dlp.com">www.dlp.com</a>
DSP	<a href="http://dsp.ti.com">dsp.ti.com</a>
Clocks and Timers	<a href="http://www.ti.com/clocks">www.ti.com/clocks</a>
Interface	<a href="http://interface.ti.com">interface.ti.com</a>
Logic	<a href="http://logic.ti.com">logic.ti.com</a>
Power Mgmt	<a href="http://power.ti.com">power.ti.com</a>
Microcontrollers	<a href="http://microcontroller.ti.com">microcontroller.ti.com</a>
RFID	<a href="http://www.ti-rfid.com">www.ti-rfid.com</a>
OMAP Applications Processors	<a href="http://www.ti.com/omap">www.ti.com/omap</a>
Wireless Connectivity	<a href="http://www.ti.com/wirelessconnectivity">www.ti.com/wirelessconnectivity</a>

### Applications

Automotive and Transportation	<a href="http://www.ti.com/automotive">www.ti.com/automotive</a>
Communications and Telecom	<a href="http://www.ti.com/communications">www.ti.com/communications</a>
Computers and Peripherals	<a href="http://www.ti.com/computers">www.ti.com/computers</a>
Consumer Electronics	<a href="http://www.ti.com/consumer-apps">www.ti.com/consumer-apps</a>
Energy and Lighting	<a href="http://www.ti.com/energy">www.ti.com/energy</a>
Industrial	<a href="http://www.ti.com/industrial">www.ti.com/industrial</a>
Medical	<a href="http://www.ti.com/medical">www.ti.com/medical</a>
Security	<a href="http://www.ti.com/security">www.ti.com/security</a>
Space, Avionics and Defense	<a href="http://www.ti.com/space-avionics-defense">www.ti.com/space-avionics-defense</a>
Video and Imaging	<a href="http://www.ti.com/video">www.ti.com/video</a>

### TI E2E Community

[e2e.ti.com](http://e2e.ti.com)