

ALTERA  
ENPIRION  
POWERSOC



ALTERA  
SOC

ALTERA  
Arria  
Series



ALTERA  
MAX  
Series



ALTERA  
Cyclone  
Series

ALTERA  
Stratix  
Series



## Contents

|  |  |    |
|--|--|----|
| <b>Overview</b>                                      | ▪ Altera® Solutions Portfolio                  | 1  |
| <b>Devices</b>                                       | ▪ 20 nm Device Portfolio                       | 2  |
|  | ▪ 28 nm Device Portfolio                       | 7  |
|  | ▪ 40 nm Device Portfolio                       | 27 |
|  | ▪ 60 nm Device Portfolio                       | 34 |
|  | ▪ MAX® CPLD Series                             | 40 |
|  | ▪ Enpirion® Power Portfolio                    | 43 |
|  | ▪ Configuration Devices                        | 47 |
| <b>Ordering Codes</b>                                | ▪ Ordering Codes                               | 48 |
| <b>Design Software Tools and Embedded Processing</b> | ▪ Quartus® II Software                         | 52 |
|  | ▪ SoC Embedded Design Suite                    | 55 |
|  | ▪ Altera's Customizable Processor Portfolio    | 56 |
|  | ▪ Nios® II Processor                           | 59 |
| <b>Intellectual Property (IP)</b>                    | ▪ Altera and Partner Functions                 | 61 |
| <b>Protocols</b>                                     | ▪ Transceiver Protocols                        | 65 |
| <b>Development Kits</b>                              | ▪ Altera and Partner Development Kits          | 67 |
| <b>Training</b>                                      | ▪ Training Overview                            | 82 |
|  | ▪ Instructor-Led and Virtual Classroom Courses | 83 |
|  | ▪ Online Training                              | 84 |
| <b>References</b>                                    | ▪ Glossary                                     | 87 |
|  | ▪ Notes  | 88 |

Altera delivers the broadest portfolio of programmable logic devices—FPGAs, SoCs, and CPLDs in combination with software tools, intellectual property (IP), embedded processors, customer support, and technical training. Altera’s product leadership, excellent value, and superior quality of service give you a measurable advantage. Bring your great ideas to life faster, better, and more cost effectively.

FPGAs

Altera FPGAs give you the flexibility to innovate, differentiate, and stay ahead in the market. We have three classes of FPGAs to meet your market needs, from the industry’s highest density and performance to the most cost effective.

| High-End FPGAs   | Midrange FPGAs  | Lowest Cost and Power FPGAs   |
|--|---|---|
|   |    |    |
| <ul style="list-style-type: none"> <li>■ Highest bandwidth, highest density FPGAs</li> <li>■ Integrated transceiver variants</li> <li>■ Design entire systems on a chip</li> </ul> | <ul style="list-style-type: none"> <li>■ Balanced cost, power, and performance FPGAs</li> <li>■ Integrated transceiver and processor variants</li> <li>■ Comprehensive design protection</li> </ul> | <ul style="list-style-type: none"> <li>■ Lowest system cost and power FPGAs</li> <li>■ Integrated transceiver and processor variants</li> <li>■ Fastest time to market</li> </ul> |



**SoCs**

SoCs consolidate two discrete devices into one, reducing system power, cost, and board size while increasing performance. SoCs integrate an ARM-based hard processor system (HPS) consisting of a dual-core ARM® processor, peripherals, and memory controllers with the FPGA fabric using a high-bandwidth interconnect backbone.

Power

Power your FPGA with Enpirion power management products. Our integrated products provide an industry-leading combination of small footprint, low noise performance, and high efficiency to complete your design faster.





**CPLDs**

For glue logic and any control functions, our non-volatile MAX series comprises the market’s lowest cost CPLDs—a single-chip solution, great for interface bridging, level shifting, I/O expansion, and management of analog I/Os.

Productivity-Enhancing Design Software, Embedded Processing, IP, Development Kits, and Training

With Altera, you get a complete design environment and a wide choice of design tools—all built to work together easily so your designs are up and running fast. You can try one of our training classes to get a jump-start on your designs. Choose Altera and see how we enhance your productivity and make a difference to your bottom line.



The following features, packages, and I/O matrices give you an overview of our devices. To get more details about these devices or other older devices that are available, check out our online selector guide at [www.altera.com/selector](http://www.altera.com/selector).

Arria® 10 GX FPGAs: Up to 96 full-duplex transceivers with data rates up to 17.4 Gbps, 16 Gbps backplane, and up to 1,150K equivalent logic elements (LEs).

|                        |   | Maximum Resource Count for Arria 10 GX FPGAs <sup>1</sup>   |         |         |         |         |         |           |           |           |
|------------------------|---|---|---------|---------|---------|---------|---------|-----------|-----------|-----------|
|                        |   | 10AX016   | 10AX022 | 10AX027 | 10AX032 | 10AX048 | 10AX057 | 10AX066   | 10AX090   | 10AX115   |
| Resources              | Adaptive logic modules (ALMs)                             | 61,510  | 83,730  | 101,620 | 118,730 | 181,790 | 217,080 | 250,540   | 339,620   | 427,200   |
|                        | LEs (K)   | 160   | 220     | 270     | 320     | 480     | 570     | 660       | 900       | 1,150     |
|                        | Registers   | 246,040   | 334,920 | 406,480 | 474,920 | 727,160 | 868,320 | 1,002,160 | 1,358,480 | 1,708,800 |
|                        | M20K memory blocks  | 440   | 588     | 750     | 891     | 1,438   | 1,800   | 2,133     | 2,423     | 2,713     |
|                        | M20K memory (Mb)  | 9   | 11      | 15      | 17      | 28      | 35      | 42        | 47        | 53        |
|                        | MLAB memory (Mb)  | 1   | 1.8     | 2.4     | 2.8     | 4.3     | 5.0     | 5.7       | 9.2       | 12.7      |
|                        | Variable-precision digital signal processing (DSP) blocks | 156   | 192     | 800     | 985     | 1,368   | 1,612   | 1,855     | 1,518     | 1,518     |
|                        | 18 x 19 multipliers                                       | 312   | 382     | 1,660   | 1,970   | 2,736   | 3,046   | 3,356     | 3,036     | 3,036     |
| Architectural Features | Global clock networks                                     | 32  |         |         |         |         |         |           |           |           |
|                        | Regional clock networks                                   | 8   | 8       | 8       | 8       | 8       | 8       | 16        | 16        | 16        |
|                        | Design security   | Bitstream encryption with authentication  |         |         |         |         |         |           |           |           |
| I/O Features           | I/O voltage levels supported (V)                          | 1.2, 1.25, 1.35, 1.8, 2.5, 3.0 <sup>2</sup>   |         |         |         |         |         |           |           |           |
|                        | I/O standards supported                                   | <b>3 V I/Os Only:</b> 3 V LVTTTL, 2.5 V CMOS<br><b>DDR and LVDS I/Os:</b> POD12, POD10, Differential POD12, Differential POD10, LVDS, RSDS, mini-LVDS, LVPECL<br><b>All I/Os:</b> 1.8 V CMOS, 1.5 V CMOS, 1.2 V CMOS, SSTL-18 (I and II), SSTL-15 (I and II), SSTL-135, SSTL-125, SSTL-12, HSTL-18 (I and II), HSTL-15 (I and II), HSTL-12 (I and II), HSUL-12, Differential SSTL-18 (I and II), Differential SSTL-15 (I and II), Differential SSTL-135, Differential SSTL-125, Differential SSTL-12, Differential HSTL-18 (I and II), Differential HSTL-15 (I and II), Differential HSTL-12 (I and II), Differential HSUL-12 |         |         |         |         |         |           |           |           |
|                        | LVDS channels, 1.6 Gbps (receive/transmit)                | 120   | 120     | 168     | 168     | 222     | 324     | 324       | 384       | 384       |
|                        | Embedded dynamic phase alignment (DPA) circuitry          | ✓   |         |         |         |         |         |           |           |           |
|                        | On-chip termination (OCT)                                 | Series, parallel, and differential  |         |         |         |         |         |           |           |           |
|                        | Transceiver count   | 12  | 12      | 24      | 24      | 36      | 48      | 48        | 96        | 96        |
|                        | PCI Express® (PCIe®) hard IP blocks (Gen3)                | 1   | 1       | 2       | 2       | 2       | 2       | 2         | 4         | 4         |
|                        | Memory devices supported                                  | DDR4, DDR3, DDR2, QDR IV, QDR II+, QDR II+ Xtreme, LPDDR3, LPDDR2, RLD RAM 3, RLD RAM II, LLD RAM II, HMC   |         |         |         |         |         |           |           |           |

<sup>1</sup> All data is correct at the time of printing, and may be subject to change without prior notice. For the latest information, please visit [www.altera.com](http://www.altera.com).

<sup>2</sup> 3.0 V compliant, requires a 3 V power supply.

Arria 10 GT FPGAs: Up to 96 full-duplex optimized transceivers with data rates up to 28 Gbps, and up to 1,150K equivalent logic elements.

|                        |  | Maximum Resource Count for Arria 10 GT FPGAs <sup>1</sup>   |           |
|------------------------|--|---|-----------|
|                        |  | 10AT090   | 10AT115   |
| Resources              | ALMs                                       | 339,620   | 427,200   |
|                        | LEs (K)                                    | 900   | 1,150     |
|                        | Registers                                  | 1,358,480   | 1,708,800 |
|                        | M20K memory blocks                         | 2,423   | 2,713     |
|                        | M20K memory (Mb)                           | 47  | 53        |
|                        | MLAB memory (Mb)                           | 9.2   | 12.7      |
|                        | Variable-precision DSP blocks              | 1,518   | 1,518     |
|                        | 18 x 19 multipliers                        | 3,036   | 3,036     |
| Architectural Features | Global clock networks                      | 32  |           |
|                        | Regional clock networks                    | 16  | 16        |
|                        | Design security                            | Bitstream encryption with authentication  |           |
| I/O Features           | I/O voltage levels supported (V)           | 1.2, 1.25, 1.35, 1.8, 2.5, 3.0 <sup>2</sup>   |           |
|                        | I/O standards supported                    | <b>3 V I/Os Only:</b> 3 V LVTTTL, 2.5 V CMOS<br><b>DDR and LVDS I/Os:</b> POD12, POD10, Differential POD12, Differential POD10, LVDS, RSDS, mini-LVDS, LVPECL<br><b>All I/Os:</b> 1.8 V CMOS, 1.5 V CMOS, 1.2 V CMOS, SSTL-18 (I and II), SSTL-15 (I and II), SSTL-135, SSTL-125, SSTL-12, HSTL-18 (I and II), HSTL-15 (I and II), HSTL-12 (I and II), HSUL-12, Differential SSTL-18 (I and II), Differential SSTL-15 (I and II), Differential SSTL-135, Differential SSTL-125, Differential SSTL-12, Differential HSTL-18 (I and II), Differential HSTL-15 (I and II), Differential HSTL-12 (I and II), Differential HSUL-12 |           |
|                        | LVDS channels, 1.6 Gbps (receive/transmit) | 312   | 312       |
|                        | Embedded DPA circuitry                     | ✓   |           |
|                        | OCT  | Series, parallel, and differential  |           |
|                        | Transceiver count                          | 96  | 96        |
|                        | PCIe hard IP blocks (Gen3)                 | 4   | 4         |
|                        | Memory devices supported                   | DDR4, DDR3, DDR2, QDR IV, QDR II+, QDR II+ Xtreme, LPDDR3, LPDDR2, RLD RAM 3, RLD RAM II, LLD RAM II, HMC   |           |

<sup>1</sup>All data is correct at the time of printing, and may be subject to change without prior notice. For the latest information, please visit [www.altera.com](http://www.altera.com).

<sup>2</sup>3.0 V compliant, requires a 3 V power supply.

The 20 nm Arria 10 SoCs deliver all the features and benefits of Arria 10 FPGAs plus a second-generation hard processor system with 87 percent higher processor performance (1.5 GHz dual-core ARM Cortex™-A9 MPCore™) and enhancements, such as secure boot, three Ethernet Media Access Controller (EMAC) hard IP cores, and 64 bit DDR4 SDRAM support—all while maintaining full software compatibility with 28 nm SoCs.

|                        |  | Maximum Resource Count for Arria 10 SX SoC <sup>1</sup>   |         |         |         |         |         |           |
|------------------------|--|---|---------|---------|---------|---------|---------|-----------|
|                        |  | 10AS016   | 10AS022 | 10AS027 | 10AS032 | 10AS048 | 10AS057 | 10AS066   |
| Resources              | ALMs                                       | 61,510  | 83,730  | 101,620 | 118,730 | 181,790 | 217,080 | 250,540   |
|                        | LEs (K)                                    | 160   | 220     | 270     | 320     | 480     | 570     | 660       |
|                        | Registers                                  | 246,040   | 334,920 | 406,480 | 474,920 | 727,160 | 868,320 | 1,002,160 |
|                        | M20K memory blocks                         | 440   | 588     | 750     | 891     | 1,438   | 1,800   | 2,133     |
|                        | M20K memory (Mb)                           | 9   | 11      | 15      | 17      | 28      | 35      | 42        |
|                        | MLAB memory (Mb)                           | 1   | 1.8     | 2.4     | 2.8     | 4.3     | 5.0     | 5.7       |
|                        | DSP blocks                                 | 156   | 192     | 800     | 985     | 1,368   | 1,612   | 1,855     |
|                        | 18 x 19 multipliers                        | 312   | 382     | 1,660   | 1,970   | 2,736   | 3,046   | 3,356     |
| Architectural Features | Global clock networks                      | 32  |         |         |         |         |         |           |
|                        | Regional clock networks                    | 8   | 8       | 8       | 8       | 8       | 8       | 16        |
| I/O Features           | I/O voltage levels supported (V)           | 1.2, 1.25, 1.35, 1.8, 2.5, 3.0 <sup>2</sup>   |         |         |         |         |         |           |
|                        | I/O standards supported                    | <b>3 V I/Os Only:</b> 3 V LVTTTL, 2.5 V CMOS<br><b>DDR and LVDS I/Os:</b> POD12, POD10, Differential POD12, Differential POD10, LVDS, RSDS, mini-LVDS, LVPECL<br><b>All I/Os:</b> 1.8 V CMOS, 1.5 V CMOS, 1.2 V CMOS, SSTL-18 (I and II), SSTL-15 (I and II), SSTL-135, SSTL-125, SSTL-12, HSTL-18 (I and II), HSTL-15 (I and II), HSTL-12 (I and II), HSUL-12, Differential SSTL-18 (I and II), Differential SSTL-15 (I and II), Differential SSTL-135, Differential SSTL-125, Differential SSTL-12, Differential HSTL-18 (I and II), Differential HSTL-15 (I and II), Differential HSTL-12 (I and II), Differential HSUL-12 |         |         |         |         |         |           |
|                        | LVDS channels, 1.6 Gbps (receive/transmit) | 120   | 120     | 168     | 168     | 222     | 270     | 270       |
|                        | Embedded DPA circuitry                     | ✓   |         |         |         |         |         |           |
|                        | OCT  | Series, parallel, and differential  |         |         |         |         |         |           |
|                        | Transceiver count                          | 12  | 12      | 24      | 24      | 36      | 48      | 48        |
|                        | PCIe hard IP blocks (Gen3)                 | 1   | 1       | 2       | 2       | 2       | 2       | 2         |
|                        | Memory devices supported                   | DDR4, DDR3, DDR2, QDR IV, QDR II+, QDR II+ Xtreme, LPDDR3, LPDDR2, RLD RAM 3, RLD RAM II, LLD RAM II, HMC   |         |         |         |         |         |           |

<sup>1</sup> All data is correct at the time of printing, and may be subject to change without prior notice. For the latest information, please visit [www.altera.com](http://www.altera.com).

<sup>2</sup> 3.0 V compliant, requires a 3 V power supply.

|                       |   | Maximum Resource Count for Arria 10 SX SoC <sup>1</sup>   |         |         |         |         |         |         |
|-----------------------|---|---|---------|---------|---------|---------|---------|---------|
|                       |   | 10AS016   | 10AS022 | 10AS027 | 10AS032 | 10AS048 | 10AS057 | 10AS066 |
| Hard Processor System | Central processing unit (CPU) core                      | Dual-core ARM Cortex-A9 MPCore processor  |         |         |         |         |         |         |
|                       | CPU cache and Co-processors                             | L1 instruction cache (32 KB)<br>L1 data cache (32 KB)<br>Layer 2 cache (512 KB) shared<br>Floating-point unit (FPU) single and double precision<br>ARM Neon™ media engine<br>ARM CoreSight™ debug and trace technology<br>Snoop control unit (SCU)<br>Acceleration coherency port (ACP) |         |         |         |         |         |         |
|                       | Scratch pad RAM   | 256 KB  |         |         |         |         |         |         |
|                       | HPS DDR memory  | DDR4 and DDR3 (Up to 64 bit with ECC)   |         |         |         |         |         |         |
|                       | Direct Memory Access (DMA) controller                   | 8-channel   |         |         |         |         |         |         |
|                       | EMAC  | 3 x 10/100/1000 EMAC with integrated DMA  |         |         |         |         |         |         |
|                       | USB On-The-Go controller (OTG)                          | 2 x USB OTG with integrated DMA   |         |         |         |         |         |         |
|                       | UART controller   | 2 x UART 16550 compatible   |         |         |         |         |         |         |
|                       | Serial Peripheral Interface (SPI) controller            | 4 x SPI   |         |         |         |         |         |         |
|                       | I <sup>2</sup> C controller                             | 5 x I <sup>2</sup> C  |         |         |         |         |         |         |
|                       | Quad SPI flash controller                               | 1 x SIO, DIO, QIO SPI flash supported   |         |         |         |         |         |         |
|                       | SD/SDIO/MMC controller                                  | 1 x eMMC 4.5 with DMA and CE-ATA support  |         |         |         |         |         |         |
|                       | NAND flash controller                                   | 1 x ONFI 1.0 or later<br>8 and 16 bit support   |         |         |         |         |         |         |
|                       | General-purpose timers                                  | 7X  |         |         |         |         |         |         |
|                       | Software-programmable general-purpose I/Os (GPIOs)      | Max 54 GPIO   |         |         |         |         |         |         |
|                       | Direct shared I/Os                                      | 48 I/O to connect HPS peripherals directly to I/O   |         |         |         |         |         |         |
|                       | Watchdog timers   | 4X  |         |         |         |         |         |         |
| Security              | Secure boot, Advanced Encryption Standard (AES) and SHA |   |         |         |         |         |         |         |

<sup>1</sup>All data is correct at the time of printing, and may be subject to change without prior notice. For the latest information, please visit [www.altera.com](http://www.altera.com).

| Arria 10 GX/GT FPGAs <sup>1</sup> |   |   |   |   |   |   |
|-----------------------------------|---|---|---|---|---|---|
|                                   | UBGA (U)                                      | FBGA (F)                                      |   |   |   |   |
|                                   | 484 pin (U19)<br>19 x 19 (mm)<br>0.8-mm pitch | 672 pin (F27)<br>27 x 27 (mm)<br>1.0-mm pitch | 780 pin (F29)<br>29 x 29 (mm)<br>1.0-mm pitch | 1,152 pin (F34)<br>35 x 35 (mm)<br>1.0-mm pitch | 1,152 pin (F35)<br>35 x 35 (mm)<br>1.0-mm pitch | 1,152 pin (F36)<br>35 x 35 (mm)<br>1.0-mm pitch |
| 10AX016                           | 192, 48, 72, 6                                | 240, 48, 96, 12                               | 288, 48, 120, 12                              |   |   |   |
| 10AX022                           | 192, 48, 72, 6                                | 240, 48, 96, 12                               | 288, 48, 120, 12                              |   |   |   |
| 10AX027                           |   | 240, 48, 96, 12                               | 360, 48, 156, 12                              | 384, 48, 168, 24                                | 384, 48, 168, 24                                |   |
| 10AX032                           |   | 240, 48, 96, 12                               | 360, 48, 156, 12                              | 384, 48, 168, 24                                | 384, 48, 168, 24                                |   |
| 10AX048                           |   |   | 360, 48, 156, 12                              | 492, 48, 222, 24                                | 396, 48, 174, 36                                |   |
| 10AX057                           |   |   |   | 492, 48, 222, 24                                | 396, 48, 174, 36                                | 432, 48, 192, 36                                |
| 10AX066                           |   |   |   | 492, 48, 222, 24                                | 396, 48, 174, 36                                | 432, 48, 192, 36                                |
| 10AX090                           |   |   |   | 504, 0, 252, 24                                 |   | 432, 0, 216, 36                                 |
| 10AX115                           |   |   |   | 504, 0, 252, 24                                 |   | 432, 0, 216, 36                                 |

| Arria 10 GX/GT FPGAs <sup>1</sup> |   |   |   |   |   |   |
|-----------------------------------|---|---|---|---|---|---|
|                                   | FBGA (F)  |   |   |   |   |   |
|                                   | 1,517 pin (F40)<br>40 x 40 (mm)<br>1.0-mm pitch | 1,517 pin (F40)<br>40 x 40 (mm)<br>1.0-mm pitch | 1,517 pin (F40)<br>40 x 40 (mm)<br>1.0-mm pitch | 1,932 pin (F45)<br>45 x 45 (mm)<br>1.0-mm pitch | 1,932 pin (F45)<br>45 x 45 (mm)<br>1.0-mm pitch | 1,932 pin (F45)<br>45 x 45 (mm)<br>1.0-mm pitch |
| 10AX027                           |   |   |   |   |   |   |
| 10AX032                           |   |   |   |   |   |   |
| 10AX048                           |   |   |   |   |   |   |
| 10AX057                           | 696, 48, 324, 36                                | 588, 48, 270, 48                                |   |   |   |   |
| 10AX066                           | 696, 48, 324, 36                                | 588, 48, 270, 48                                |   |   |   |   |
| 10AX090                           |   | 600, 0, 300, 48                                 | 342, 0, 154, 66                                 | 768, 0, 384, 48                                 | 624, 0, 312, 72                                 | 480, 0, 240, 96                                 |
| 10AX115                           |   | 600, 0, 300, 48                                 | 342, 0, 154, 66                                 | 768, 0, 384, 48                                 | 624, 0, 312, 72                                 | 480, 0, 240, 96                                 |
| 10AT090                           |   | 600, 0, 300, 48                                 |   |   | 624, 0, 312, 72                                 | 480, 0, 240, 96                                 |
| 10AT115                           |   | 600, 0, 300, 48                                 |   |   | 624, 0, 312, 72                                 | 480, 0, 240, 96                                 |

| Arria 10 SX SoCs <sup>1</sup> |   |   |   |   |   |   |   |
|-------------------------------|---|---|---|---|---|---|---|
|                               | UBGA (U)                                      | FBGA (F)                                      |   |   |   |   |   |
|                               | 484 pin (U19)<br>19 x 19 (mm)<br>0.8-mm pitch | 672 pin (F27)<br>27 x 27 (mm)<br>1.0-mm pitch | 780 pin (F29)<br>29 x 29 (mm)<br>1.0-mm pitch | 1,152 pin (F34)<br>35 x 35 (mm)<br>1.0-mm pitch | 1,152 pin (F35)<br>35 x 35 (mm)<br>1.0-mm pitch | 1,517 pin (F40)<br>40 x 40 (mm)<br>1.0-mm pitch | 1,517 pin (F40)<br>40 x 40 (mm)<br>1.0-mm pitch |
| 10AS016                       | 192, 48, 72, 6                                | 240, 48, 96, 12                               | 288, 48, 120, 12                              |   |   |   |   |
| 10AS022                       | 192, 48, 72, 6                                | 240, 48, 96, 12                               | 288, 48, 120, 12                              |   |   |   |   |
| 10AS027                       |   | 240, 48, 96, 12                               | 360, 48, 156, 12                              | 384, 48, 168, 24                                | 384, 48, 168, 24                                |   |   |
| 10AS032                       |   | 240, 48, 96, 12                               | 360, 48, 156, 12                              | 384, 48, 168, 24                                | 384, 48, 168, 24                                |   |   |
| 10AS048                       |   |   | 360, 48, 156, 12                              | 492, 48, 222, 24                                | 396, 48, 174, 36                                |   |   |
| 10AS057                       |   |   |   | 492, 48, 222, 24                                | 396, 48, 174, 36                                | 696, 48, 324, 36                                | 588, 48, 270, 48                                |
| 10AS066                       |   |   |   | 492, 48, 222, 24                                | 396, 48, 174, 36                                | 696, 48, 324, 36                                | 588, 48, 270, 48                                |

<sup>1</sup> All data is correct at the time of printing, and may be subject to change without prior notice. For the latest information, please visit [www.altera.com](http://www.altera.com).

624, 48, 192, 48 Numbers indicate GPIO count, 3.0 V I/O count, LVDS count, and transceiver count.

Vertical migration (same Vcc, Gnd, ISP, and input pins). User I/Os may be less than labeled for vertical migration.

Arria 10 series devices are offered in extended and industrial temperatures, and RoHS-compliant packages.



|                        |  | Maximum Resource Count for Stratix V GT FPGAs (0.85 V) <sup>1</sup>   |         |
|------------------------|--|---|---------|
|                        |  | 5SGTC5  | 5SGTC7  |
| Resources              | ALMs                                       | 160,400   | 234,720 |
|                        | LEs (K)                                    | 425   | 622     |
|                        | Registers                                  | 641,600   | 938,880 |
|                        | M20K memory blocks                         | 2,304   | 2,560   |
|                        | M20K memory (Mb)                           | 45  | 50      |
|                        | MLAB memory (Mb)                           | 4.9   | 7.16    |
|                        | Variable-precision DSP blocks              | 256   | 256     |
|                        | 18 x 18 multipliers                        | 512   | 512     |
| Architectural Features | Global clock networks                      | 16  |         |
|                        | Regional clock networks                    | 92  |         |
|                        | Design security                            | ✓   |         |
| I/O Features           | I/O voltage levels supported (V)           | 1.2, 1.5, 1.8, 2.5, 3.3 <sup>2</sup>  |         |
|                        | I/O standards supported                    | LVTTTL, LVCMOS, PCI™, PCI-X™, LVDS, mini-LVDS, RSDS, LVPECL, Differential SSTL-15, Differential SSTL-18, Differential SSTL-2, Differential HSTL-12, Differential HSTL-5, Differential HSTL-18, SSTL-15 (I and II), SSTL-18 (I and II), SSTL-2 (I and II), 1.2 V HSTL (I and II), 1.5 V HSTL (I and II), 1.8 V HSTL (I and II) |         |
|                        | LVDS channels, 1.4 Gbps (receive/transmit) | 150   | 150     |
|                        | Embedded DPA circuitry                     | ✓   |         |
|                        | OCT  | Series, parallel, and differential  |         |
|                        | Transceiver count (28.05 Gbps/14.1 Gbps)   | 4/32  | 4/32    |
|                        | PCIe hard IP blocks (Gen3)                 | 1   | 1       |
|                        | Memory devices supported                   | DDR3, DDR2, QDR II, QDR II+, RLDRAM II, RLDRAM 3  |         |

<sup>1</sup>All data is correct at the time of printing, and may be subject to change without prior notice. For the latest information, please visit [www.altera.com](http://www.altera.com).

<sup>2</sup>3.3 V compliant, requires a 3 V power supply.

|                        |  | Maximum Resource Count for Stratix V GX FPGAs (0.85 V) <sup>1</sup>   |         |         |         |           |           |         |         |           |           |
|------------------------|--|---|---------|---------|---------|-----------|-----------|---------|---------|-----------|-----------|
|                        |  | 5SGXA3  | 5SGXA4  | 5SGXA5  | 5SGXA7  | 5SGXA9    | 5SGXAB    | 5SGXB5  | 5SGXB6  | 5SGXB9    | 5SGXBB    |
| Resources              | ALMs                                       | 128,300   | 158,500 | 185,000 | 234,720 | 317,000   | 359,200   | 185,000 | 225,400 | 317,000   | 359,200   |
|                        | LEs (K)                                    | 340   | 420     | 490     | 622     | 840       | 952       | 490     | 597     | 840       | 952       |
|                        | Registers                                  | 513,200   | 634,000 | 740,000 | 938,880 | 1,268,000 | 1,436,800 | 740,000 | 901,600 | 1,268,000 | 1,436,800 |
|                        | M20K memory blocks                         | 957   | 1,900   | 2,304   | 2,560   | 2,640     | 2,640     | 2,100   | 2,660   | 2,640     | 2,640     |
|                        | M20K memory (Mb)                           | 19  | 37      | 45      | 50      | 52        | 52        | 41      | 52      | 52        | 52        |
|                        | MLAB memory (Mb)                           | 3.92  | 4.84    | 5.65    | 7.16    | 9.67      | 10.96     | 5.65    | 6.88    | 9.67      | 10.96     |
|                        | Variable-precision DSP blocks              | 256   | 256     | 256     | 256     | 352       | 352       | 399     | 399     | 352       | 352       |
|                        | 18 x 18 multipliers                        | 512   | 512     | 512     | 512     | 704       | 704       | 798     | 798     | 704       | 704       |
| Architectural Features | Global clock networks                      | 16  |         |         |         |           |           |         |         |           |           |
|                        | Regional clock networks                    | 92  |         |         |         |           |           |         |         |           |           |
|                        | Design security                            | ✓   |         |         |         |           |           |         |         |           |           |
| I/O Features           | I/O voltage levels supported (V)           | 1.2, 1.5, 1.8, 2.5, 3.3 <sup>2</sup>  |         |         |         |           |           |         |         |           |           |
|                        | I/O standards supported                    | LVTTTL, LVCMOS, PCI, PCI-X, LVDS, mini-LVDS, RSDS, LVPECL, Differential SSTL-15, Differential SSTL-18, Differential SSTL-2, Differential HSTL-12, Differential HSTL-5, Differential HSTL-18, SSTL-15 (I and II), SSTL-18 (I and II), SSTL-2 (I and II), 1.2 V HSTL (I and II), 1.5 V HSTL (I and II), 1.8 V HSTL (I and II) |         |         |         |           |           |         |         |           |           |
|                        | LVDS channels, 1.4 Gbps (receive/transmit) | 174   | 174     | 210     | 210     | 210       | 210       | 150     | 150     | 150       | 150       |
|                        | Embedded DPA circuitry                     | ✓   |         |         |         |           |           |         |         |           |           |
|                        | OCT  | Series, parallel, and differential  |         |         |         |           |           |         |         |           |           |
|                        | Transceiver count (14.1 Gbps)              | 36  | 36      | 48      | 48      | 48        | 48        | 66      | 66      | 66        | 66        |
|                        | PCIe hard IP blocks (Gen3)                 | 2   | 2       | 4       | 4       | 4         | 4         | 4       | 4       | 4         | 4         |
|                        | Memory devices supported                   | DDR3, DDR2, QDR II, QDR II+, RLDRAM II, RLDRAM 3  |         |         |         |           |           |         |         |           |           |

<sup>1</sup> All data is correct at the time of printing, and may be subject to change without prior notice. For the latest information, please visit [www.altera.com](http://www.altera.com).

<sup>2</sup> 3.3 V compliant, requires a 3 V power supply.

|                        |  | Maximum Resource Count for Stratix V GS FPGAs (0.85 V) <sup>1</sup>   |         |         |         |           |
|------------------------|--|---|---------|---------|---------|-----------|
|                        |  | 5SGSD3  | 5SGSD4  | 5SGSD5  | 5SGSD6  | 5SGSD8    |
| Resources              | ALMs                                       | 89,000  | 135,840 | 172,600 | 220,000 | 262,400   |
|                        | LEs (K)                                    | 236   | 360     | 457     | 583     | 695       |
|                        | Registers                                  | 356,000   | 543,360 | 690,400 | 880,000 | 1,049,600 |
|                        | M20K memory blocks                         | 688   | 957     | 2,014   | 2,320   | 2,567     |
|                        | M20K memory (Mb)                           | 13  | 19      | 39      | 45      | 50        |
|                        | MLAB memory (Mb)                           | 2.72  | 4.15    | 5.27    | 6.71    | 8.01      |
|                        | Variable-precision DSP blocks              | 600   | 1,044   | 1,590   | 1,775   | 1,963     |
|                        | 18 x 18 multipliers                        | 1,200   | 2,088   | 3,180   | 3,550   | 3,926     |
| Architectural Features | Global clock networks                      | 16  |         |         |         |           |
|                        | Regional clock networks                    | 92  |         |         |         |           |
|                        | Design security                            | ✓   |         |         |         |           |
| I/O Features           | I/O voltage levels supported (V)           | 1.2, 1.5, 1.8, 2.5, 3.3 <sup>2</sup>  |         |         |         |           |
|                        | I/O standards supported                    | LVTTTL, LVCMOS, PCI, PCI-X, LVDS, mini-LVDS, RSDS, LVPECL, Differential SSTL-15, Differential SSTL-18, Differential SSTL-2, Differential HSTL-12, Differential HSTL-5, Differential HSTL-18, SSTL-15 (I and II), SSTL-18 (I and II), SSTL-2 (I and II), 1.2 V HSTL (I and II), 1.5 V HSTL (I and II), 1.8 V HSTL (I and II) |         |         |         |           |
|                        | LVDS channels, 1.4 Gbps (receive/transmit) | 108   | 174     | 174     | 210     | 210       |
|                        | Embedded DPA circuitry                     | ✓   |         |         |         |           |
|                        | OCT  | Series, parallel, and differential  |         |         |         |           |
|                        | Transceiver count (14.1 Gbps)              | 24  | 36      | 36      | 48      | 48        |
|                        | PCIe hard IP blocks (Gen3)                 | 1   | 1       | 1       | 2       | 2         |
|                        | Memory devices supported                   | DDR3, DDR2, DDR, QDR II, QDR II+, RLD RAM II, RLD RAM 3   |         |         |         |           |

<sup>1</sup>All data is correct at the time of printing, and may be subject to change without prior notice. For the latest information, please visit [www.altera.com](http://www.altera.com).

<sup>2</sup>3.3 V compliant, requires a 3 V power supply.

|                        |  | Maximum Resource Count for Stratix V E FPGAs (0.85 V) <sup>1</sup>  |           |
|------------------------|--|---|-----------|
|                        |  | 5SEE9   | 5SEEB     |
| Resources              | ALMs                                       | 317,000   | 359,200   |
|                        | LEs (K)                                    | 840   | 952       |
|                        | Registers                                  | 1,268,000   | 1,436,800 |
|                        | M20K memory blocks                         | 2,640   | 2,640     |
|                        | M20K memory (Mb)                           | 52  | 52        |
|                        | MLAB memory (Mb)                           | 9.67  | 10.96     |
|                        | Variable-precision DSP blocks              | 352   | 352       |
|                        | 18 x 18 multipliers                        | 704   | 704       |
| Architectural Features | Global clock networks                      | 16  |           |
|                        | Regional clock networks                    | 92  |           |
|                        | Design security                            | ✓   |           |
| I/O Features           | I/O voltage levels supported (V)           | 1.2, 1.5, 1.8, 2.5, 3.3 <sup>2</sup>  |           |
|                        | I/O standards supported                    | LVTTTL, LVCMOS, PCI, PCI-X, LVDS, mini-LVDS, RSDS, LVPECL, Differential SSTL-15, Differential SSTL-18, Differential SSTL-2, Differential HSTL-12, Differential HSTL-5, Differential HSTL-18, SSTL-15 (I and II), SSTL-18 (I and II), SSTL-2 (I and II), 1.2 V HSTL (I and II), 1.5 V HSTL (I and II), 1.8 V HSTL (I and II) |           |
|                        | LVDS channels, 1.4 Gbps (receive/transmit) | 210   | 210       |
|                        | Embedded DPA circuitry                     | ✓   |           |
|                        | OCT  | Series, parallel, and differential  |           |
|                        | Memory devices supported                   | DDR3, DDR2, QDR II, QDR II+, RLD RAM II, RLD RAM 3  |           |

<sup>1</sup> All data is correct at the time of printing, and may be subject to change without prior notice. For the latest information, please visit [www.altera.com](http://www.altera.com).

<sup>2</sup> 3.3 V compliant, requires a 3 V power supply.

| Stratix V GS, GX, GT, and E FPGAs (0.85 V) <sup>1</sup> |   |   |   |   |   |   |   |
|---|---|---|---|---|---|---|---|
| FBGA (F)  |   |   |   |   |   |   |   |
|   | 780 pin<br>29 x 29 (mm)<br>1.0-mm pitch | 1,152 pin<br>35 x 35 (mm)<br>1.0-mm pitch | 1,152 pin<br>35 x 35 (mm)<br>1.0-mm pitch | 1,517 pin<br>40 x 40 (mm)<br>1.0-mm pitch | 1,517 pin<br>40 x 40 (mm)<br>1.0-mm pitch | 1,760 pin<br>42.5 x 42.5 (mm)<br>1.0-mm pitch | 1,932 pin<br>45 x 45 (mm)<br>1.0-mm pitch |
| 5SGSD3  | 360, 90, 12 <sup>2</sup>                | 432, 108, 24                              |   |   |   |   |   |
| 5SGSD4  | 360, 90, 12 <sup>2</sup>                | 432, 108, 24                              |   | 696, 174, 36                              |   |   |   |
| 5SGSD5  |   | 552, 138, 24                              |   | 696, 174, 36                              |   |   |   |
| 5SGSD6  |   |   |   | 696, 174, 36                              |   |   | 840, 210, 48                              |
| 5SGSD8  |   |   |   | 696, 174, 36                              |   |   | 840, 210, 48                              |
| 5SGXA3  | 360, 90, 12 <sup>2</sup>                | 432, 108, 24                              | 432, 108, 36                              | 696, 174, 36                              |   |   |   |
| 5SGXA4  |   | 552, 138, 24                              | 432, 108, 36                              | 696, 174, 36                              |   |   |   |
| 5SGXA5  |   | 552, 138, 24                              | 432, 108, 36                              | 696, 174, 36                              | 600, 150, 48                              |   | 840, 210, 48                              |
| 5SGXA7  |   | 552, 138, 24                              | 432, 108, 36                              | 696, 174, 36                              | 600, 150, 48                              |   | 840, 210, 48                              |
| 5SGXA9  |   |   |   | 696, 174, 36 <sup>3</sup>                 |   |   | 840, 210, 48                              |
| 5SGXAB  |   |   |   | 696, 174, 36 <sup>3</sup>                 |   |   | 840, 210, 48                              |
| 5SGXB5  |   |   |   | 432, 108, 66                              |   | 600, 150, 66                                  |   |
| 5SGXB6  |   |   |   | 432, 108, 66                              |   | 600, 150, 66                                  |   |
| 5SGXB9  |   |   |   |   |   | 600, 150, 66 <sup>3</sup>                     |   |
| 5SGXBB  |   |   |   |   |   | 600, 150, 66 <sup>3</sup>                     |   |
| 5SGTC5  |   |   |   |   | 600, 150, 36 <sup>4</sup>                 |   |   |
| 5SGTC7  |   |   |   |   | 600, 150, 36 <sup>4</sup>                 |   |   |
| 5SEE9   |   |   |   | 696, 174, 0 <sup>3</sup>                  |   |   | 840, 210, 0                               |
| 5SEEB   |   |   |   | 696, 174, 0 <sup>3</sup>                  |   |   | 840, 210, 0                               |

<sup>1</sup>All data is correct at the time of printing, and may be subject to change without prior notice. For the latest information, please visit [www.altera.com](http://www.altera.com).

<sup>2</sup>Hybrid package (flip chip) FBGA: 33 x 33 (mm) 1.0-mm pitch.

<sup>3</sup>Hybrid package (flip chip) FBGA: 45 x 45 (mm) 1.0-mm pitch.

<sup>4</sup>GX–GT migration. Unused transceiver channels connected to power/ground.

264, 66, 24 Numbers indicate GPIO count, LVDS count, and transceiver count.

Vertical migration (same V<sub>CC</sub>, GND, ISP, and input pins). User I/Os may be less than labelled for vertical migration.

Stratix series devices are offered in commercial and industrial temperatures and RoHS-compliant packages. Stratix IV GT devices are only offered in industrial temperatures (0°C to 100°C).

|                                      |                                  | Maximum Resource Count for Arria V GX FPGAs (1.1 V, 1.15 V) <sup>1</sup>  |         |         |         |         |         |         |         |
|--------------------------------------|----------------------------------|---|---------|---------|---------|---------|---------|---------|---------|
|                                      |                                  | 5AGXA1  | 5AGXA3  | 5AGXA5  | 5AGXA7  | 5AGXB1  | 5AGXB3  | 5AGXB5  | 5AGXB7  |
| Resources                            | ALMs                             | 28,302  | 58,900  | 71,698  | 91,680  | 113,208 | 136,880 | 158,491 | 190,240 |
|                                      | LEs (K)                          | 75  | 156     | 190     | 242     | 300     | 362     | 420     | 504     |
|                                      | Registers                        | 113,208   | 235,600 | 286,792 | 366,720 | 452,832 | 547,520 | 633,964 | 760,960 |
|                                      | M10K memory blocks               | 800   | 1,051   | 1,180   | 1,366   | 1,510   | 1,726   | 2,054   | 2,414   |
|                                      | M10K memory (Kb)                 | 8,000   | 10,510  | 11,800  | 13,660  | 15,100  | 17,260  | 20,540  | 24,140  |
|                                      | MLAB memory (Kb)                 | 463   | 961     | 1,173   | 1,448   | 1,852   | 2,098   | 2,532   | 2,906   |
|                                      | Variable-precision DSP blocks    | 240   | 396     | 600     | 800     | 920     | 1,045   | 1,092   | 1,156   |
|                                      | 18 x 18 multipliers              | 480   | 792     | 1,200   | 1,600   | 1,840   | 2,090   | 2,184   | 2,312   |
| Architectural Features               | Global clock networks            | 16  |         |         |         |         |         |         |         |
|                                      | PLLs <sup>2</sup>                | 10  | 10      | 12      | 12      | 12      | 12      | 16      | 16      |
|                                      | Design security                  | ✓   |         |         |         |         |         |         |         |
| I/O Features                         | I/O voltage levels supported (V) | 1.2, 1.5, 1.8, 2.5, 3.0, 3.3  |         |         |         |         |         |         |         |
|                                      | I/O standards supported          | LVTTL, LVCMOS, PCI, PCI-X, LVDS, mini-LVDS, RSDS, LVPECL, Differential SSTL-15, Differential SSTL-18, Differential SSTL-2, Differential HSTL-12, Differential HSTL-15, Differential HSTL-18, SSTL-15 (I and II), SSTL-18 (I and II), SSTL-2 (I and II), 1.2 V HSTL (I and II), 1.5 V HSTL (I and II), 1.8 V HSTL (I and II) |         |         |         |         |         |         |         |
|                                      | LVDS transmitter (TX)            | 70  | 70      | 120     | 120     | 160     | 160     | 160     | 160     |
|                                      | LVDS receiver (RX)               | 80  | 80      | 136     | 136     | 176     | 176     | 176     | 176     |
|                                      | Embedded DPA circuitry           | ✓   |         |         |         |         |         |         |         |
|                                      | OCT                              | Series and differential   |         |         |         |         |         |         |         |
|                                      | Programmable drive strength      | ✓   |         |         |         |         |         |         |         |
|                                      | Transceiver count (6.5536 Gbps)  | 9   | 9       | 24      | 24      | 24      | 24      | 36      | 36      |
|                                      | PCIe hard IP blocks (Gen2 x4)    | 1   | 1       | 2       | 2       | 2       | 2       | 2       | 2       |
| Hard memory controllers <sup>3</sup> | 2                                | 2   | 4       | 4       | 4       | 4       | 4       | 4       |         |
| External Memory Interfaces           | Memory devices supported         | DDR3, DDR2, DDR II+ <sup>4</sup> , QDR II, QDR II+, RLDRAM II, LPDDR <sup>4</sup> , LPDDR2 <sup>4</sup>   |         |         |         |         |         |         |         |

<sup>1</sup>All data is correct at the time of printing, and may be subject to change without prior notice. For the latest information, please visit [www.altera.com](http://www.altera.com).

<sup>2</sup>The phase-locked loop (PLL) count includes general-purpose fractional PLLs and transceiver fractional PLLs.

<sup>3</sup>With 16 and 32 bit error correction code (ECC) support.

<sup>4</sup>These memory interfaces are not available as Altera IP.

|                                      |   | Maximum Resource Count for Arria V GT FPGAs (1.1 V, 1.15 V) <sup>1</sup>   |         |         |         |
|--------------------------------------|---|--|---------|---------|---------|
|                                      |   | 5AGTC3   | 5AGTC7  | 5AGTD3  | 5AGTD7  |
| Resources                            | ALMs  | 58,900   | 91,680  | 136,880 | 190,240 |
|                                      | LEs (K)   | 156  | 242     | 362     | 504     |
|                                      | Registers   | 235,600  | 366,720 | 547,520 | 760,960 |
|                                      | M10K memory blocks  | 1,051  | 1,366   | 1,726   | 2,414   |
|                                      | M10K memory (Kb)  | 10,510   | 13,660  | 17,260  | 24,140  |
|                                      | MLAB memory (Kb)  | 961  | 1,448   | 2,098   | 2,906   |
|                                      | Variable-precision DSP blocks                             | 396  | 800     | 1,045   | 1,156   |
|                                      | 18 x 18 multipliers                                       | 792  | 1,600   | 2,090   | 2,312   |
| Architectural Features               | Global clock networks                                     | 16   |         |         |         |
|                                      | PLLs <sup>2</sup>   | 10   | 12      | 12      | 16      |
|                                      | Design security   | ✓  |         |         |         |
| I/O Features                         | I/O voltage levels supported (V)                          | 1.2, 1.5, 1.8, 2.5, 3.0, 3.3   |         |         |         |
|                                      | I/O standards supported                                   | LVTTTL, LVCMOS, PCI, PCI-X, LVDS, mini-LVDS, RSDS, LVPECL, Differential SSTL-15, Differential SSTL-18, Differential SSTL-2, Differential HSTL-12, Differential HSTL-15, Differential HSTL-18, SSTL-15 (I and II), SSTL-18 (I and II), SSTL-2 (I and II), 1.2 V HSTL (I and II), 1.5 V HSTL (I and II), 1.8 V HSTL (I and II) |         |         |         |
|                                      | LVDS transmitter (TX)                                     | 70   | 120     | 160     | 160     |
|                                      | LVDS receiver (RX)  | 80   | 136     | 176     | 176     |
|                                      | Embedded DPA circuitry                                    | ✓  |         |         |         |
|                                      | OCT   | Series and differential  |         |         |         |
|                                      | Programmable drive strength                               | ✓  |         |         |         |
|                                      | Transceiver count (10.3125 Gbps/6.5536 Gbps) <sup>3</sup> | 4/3  | 12/6    | 12/6    | 20/6    |
|                                      | PCIe hard IP blocks (Gen2 x4)                             | 1  | 2       | 2       | 2       |
| Hard memory controllers <sup>4</sup> | 2   | 4  | 4       | 4       |         |
| External Memory Interfaces           | Memory devices supported                                  | DDR3, DDR2, DDR II+ <sup>5</sup> , QDR II, QDR II+, RLDRAM II, LPDDR <sup>5</sup> , LPDDR2 <sup>5</sup>  |         |         |         |

<sup>1</sup>All data is correct at the time of printing, and may be subject to change without prior notice. For the latest information, please visit [www.altera.com](http://www.altera.com).

<sup>2</sup>The PLL count includes general-purpose fractional PLLs and transceiver fractional PLLs.

<sup>3</sup>One pair of 10 Gbps transceiver channels can be configured as three 6 Gbps transceiver channels.

<sup>4</sup>With 16 and 32 bit ECC support.

<sup>5</sup>These memory interfaces are not available as Altera IP.

|                                     |                                  | Maximum Resource Count for Arria V GZ FPGAs (0.85 V) <sup>1</sup>  |         |         |         |
|-------------------------------------|----------------------------------|--|---------|---------|---------|
|                                     |                                  | 5AGZE1   | 5AGZE3  | 5AGZE5  | 5AGZE7  |
| Resources                           | ALMs                             | 83,020   | 135,840 | 150,960 | 169,800 |
|                                     | LEs (K)                          | 220  | 360     | 400     | 450     |
|                                     | Registers                        | 332,080  | 543,360 | 603,840 | 679,200 |
|                                     | M20K memory blocks               | 585  | 957     | 1,440   | 1,700   |
|                                     | M20K memory (Kb)                 | 11,700   | 19,140  | 28,800  | 34,000  |
|                                     | MLAB memory (Kb)                 | 2,594  | 4,245   | 4,718   | 5,306   |
|                                     | Variable-precision DSP blocks    | 800  | 1,044   | 1,092   | 1,139   |
|                                     | 18 x 18 multipliers              | 1,600  | 2,088   | 2,184   | 2,278   |
| Architectural Features              | Global clock networks            | 16   |         |         |         |
|                                     | PLLs <sup>2</sup>                | 20   | 20      | 24      | 24      |
|                                     | Design security                  | ✓  |         |         |         |
| I/O Features                        | I/O voltage levels supported (V) | 1.2, 1.5, 1.8, 2.5, 3.0, 3.3 <sup>3</sup>  |         |         |         |
|                                     | I/O standards supported          | LVTTTL, LVCMOS, PCI, PCI-X, LVDS, mini-LVDS, RSDS, LVPECL, Differential SSTL-15, Differential SSTL-18, Differential SSTL-2, Differential HSTL-12, Differential HSTL-15, Differential HSTL-18, SSTL-15 (I and II), SSTL-18 (I and II), SSTL-2 (I and II), 1.2 V HSTL (I and II), 1.5 V HSTL (I and II), 1.8 V HSTL (I and II) |         |         |         |
|                                     | LVDS transmitter (TX)            | 99   | 99      | 166     | 166     |
|                                     | LVDS receiver (RX)               | 108  | 108     | 168     | 168     |
|                                     | Embedded DPA circuitry           | ✓  |         |         |         |
|                                     | OCT                              | Series and differential  |         |         |         |
|                                     | Programmable drive strength      | ✓  |         |         |         |
|                                     | Transceiver count (12.5 Gbps)    | 24   | 24      | 36      | 36      |
| PCIe hard IP blocks (Gen2 x8, Gen3) | 1                                | 1  | 1       | 1       |         |
| External Memory Interfaces          | Memory devices supported         | DDR3, DDR2, QDR II, QDR II+, RLDRAM II, RLDRAM 3   |         |         |         |

<sup>1</sup>All data is correct at the time of printing, and may be subject to change without prior notice. For the latest information, please visit [www.altera.com](http://www.altera.com).

<sup>2</sup>The PLL count includes general-purpose fractional PLLs and transceiver fractional PLLs.

<sup>3</sup>3.3 V compliant, requires a 3 V power supply.



|                            |   | Maximum Resource Count for Arria V SX SoCs (1.1 V) <sup>1</sup>  |         |
|----------------------------|---|--|---------|
|                            |   | 5ASXB3   | 5ASXB5  |
| Resources                  | ALMs  | 132,075  | 174,340 |
|                            | LEs (K)                                     | 350  | 462     |
|                            | Registers                                   | 528,300  | 697,360 |
|                            | M10K memory blocks                          | 1,729  | 2,282   |
|                            | M10K memory (Kb)                            | 17,288   | 22,820  |
|                            | MLAB memory (Kb)                            | 2,014  | 2,658   |
|                            | Variable-precision DSP blocks               | 809  | 1,068   |
|                            | 18 x 18 multipliers                         | 1,618  | 2,186   |
| Architectural Features     | Processor cores (ARM Cortex-A9)             | Dual   | Dual    |
|                            | Global clock networks                       | 16   |         |
|                            | PLLs <sup>2</sup> (FPGA)                    | 10   | 14      |
|                            | PLLs <sup>2</sup> (HPS)                     | 3  | 3       |
|                            | Design security                             | ✓  |         |
| I/O Features               | I/O voltage levels supported (V)            | 1.2, 1.5, 1.8, 2.5, 3.0, 3.3   |         |
|                            | I/O standards supported                     | LVTTTL, LVCMOS, PCI, PCI-X, LVDS, mini-LVDS, RSDS, LVPECL, Differential SSTL-15, Differential SSTL-18, Differential SSTL-2, Differential HSTL-12, Differential HSTL-15, Differential HSTL-18, SSTL-15 (I and II), SSTL-18 (I and II), SSTL-2 (I and II), 1.2 V HSTL (I and II), 1.5 V HSTL (I and II), 1.8 V HSTL (I and II) |         |
|                            | LVDS transmitter (TX)                       | 136  | 136     |
|                            | LVDS receiver (RX)                          | 121  | 121     |
|                            | Embedded DPA circuitry                      | ✓  |         |
|                            | OCT   | Series and differential  |         |
|                            | Programmable drive strength                 | ✓  |         |
|                            | Transceiver count (6.5536 Gbps)             | 30   | 30      |
|                            | PCIe hard IP blocks (Gen2 x4)               | 2  | 2       |
|                            | GPIOs (FPGA)                                | 528  | 528     |
|                            | GPIOs (HPS)                                 | 216  | 216     |
|                            | Hard memory controllers <sup>3</sup> (FPGA) | 3  | 3       |
|                            | Hard memory controllers <sup>3</sup> (HPS)  | 1  | 1       |
| External Memory Interfaces | Memory devices supported                    | DDR3, DDR2, DDR, QDR II, QDR II+, RLDRAM II, LPDDR2 <sup>4</sup> , SDR   |         |

<sup>1</sup> All data is correct at the time of printing, and may be subject to change without prior notice. For the latest information, please visit [www.altera.com](http://www.altera.com).

<sup>2</sup> The PLL count includes general-purpose fractional PLLs and transceiver fractional PLLs.

<sup>3</sup> With 16 and 32 bit ECC support.

<sup>4</sup> These memory interfaces are not available as Altera IP.

|                            |  | Maximum Resource Count for Arria V ST SoCs (1.1 V) <sup>1</sup>  |         |
|----------------------------|--|--|---------|
|                            |  | 5ASTD3   | 5ASTD5  |
| Resources                  | ALMs   | 132,075  | 174,340 |
|                            | LEs (K)                                      | 350  | 462     |
|                            | Registers                                    | 528,300  | 697,360 |
|                            | M10K memory blocks                           | 1,729  | 2,282   |
|                            | M10K memory (Kb)                             | 17,288   | 22,820  |
|                            | MLAB memory (Kb)                             | 2,014  | 2,658   |
|                            | Variable-precision DSP blocks                | 809  | 1,068   |
|                            | 18 x 18 multipliers                          | 1,618  | 2,186   |
| Architectural Features     | Processor cores (ARM Cortex-A9)              | Dual   | Dual    |
|                            | Global clock networks                        | 16   |         |
|                            | PLLs <sup>2</sup> (FPGA)                     | 10   | 14      |
|                            | PLLs <sup>2</sup> (HPS)                      | 3  | 3       |
|                            | Design security                              | ✓  |         |
| I/O Features               | I/O voltage levels supported (V)             | 1.2, 1.5, 1.8, 2.5, 3.0, 3.3   |         |
|                            | I/O standards supported                      | LVTTTL, LVCMOS, PCI, PCI-X, LVDS, mini-LVDS, RSDS, LVPECL, Differential SSTL-15, Differential SSTL-18, Differential SSTL-2, Differential HSTL-12, Differential HSTL-15, Differential HSTL-18, SSTL-15 (I and II), SSTL-18 (I and II), SSTL-2 (I and II), 1.2 V HSTL (I and II), 1.5 V HSTL (I and II), 1.8 V HSTL (I and II) |         |
|                            | LVDS transmitter (TX)                        | 136  | 136     |
|                            | LVDS receiver (RX)                           | 121  | 121     |
|                            | Embedded DPA circuitry                       | ✓  |         |
|                            | OCT  | Series and differential  |         |
|                            | Programmable drive strength                  | ✓  |         |
|                            | Transceiver count (10.3125 Gbps/6.5536 Gbps) | 16/30  | 16/30   |
|                            | PCIe hard IP blocks (Gen2 x4)                | 2  | 2       |
|                            | GPIOs (FPGA)                                 | 528  | 528     |
|                            | GPIOs (HPS)                                  | 216  | 216     |
|                            | Hard memory controllers <sup>3</sup> (FPGA)  | 3  | 3       |
|                            | Hard memory controllers <sup>3</sup> (HPS)   | 1  | 1       |
| External Memory Interfaces | Memory devices supported                     | DDR3, DDR2, DDR, QDR II, QDR II+, RLDRAM II, LPDDR2 <sup>4</sup> , SDR   |         |

<sup>1</sup>All data is correct at the time of printing, and may be subject to change without prior notice. For the latest information, please visit [www.altera.com](http://www.altera.com).

<sup>2</sup>The PLL count includes general-purpose fractional PLLs and transceiver fractional PLLs.



<sup>3</sup>With 16 and 32 bit ECC support.

<sup>4</sup>These memory interfaces are not available as Altera IP.

| Arria V GX,GT, and GZ FPGAs (0.85 V) <sup>1</sup> |   |   |   |            |   |   |
|---|---|---|---|------------|---|---|
|   | FBGA (F)                                | Hybrid FBGA (H)                         | FBGA (F)                                |            |   |   |
|   | 672 pin<br>27 x 27 (mm)<br>1.0-mm pitch | 780 pin<br>29 x 29 (mm)<br>1.0-mm pitch | 896 pin<br>31 x 31 (mm)<br>1.0-mm pitch |            | 1,152 pin<br>35 x 35 (mm)<br>1.0-mm pitch | 1,517 pin<br>40 x 40 (mm)<br>1.0-mm pitch |
| 5AGXA1  | 336<br>9,0                              |   | 416<br>9,0                              | 320<br>9,0 |   |   |
| 5AGXA3  | 336<br>9,0                              |   | 416<br>9,0                              | 320<br>9,0 |   |   |
| 5AGXA5  | 336<br>9,0                              |   | 384<br>18,0                             | 320<br>9,0 | 544<br>24,0                               |   |
| 5AGXA7  | 336<br>9,0                              |   | 384<br>18,0                             | 320<br>9,0 | 544<br>24,0                               |   |
| 5AGXB1  |   |   | 384<br>18,0                             | 320<br>9,0 | 544<br>24,0                               | 704<br>24,0                               |
| 5AGXB3  |   |   | 384<br>18,0                             | 320<br>9,0 | 544<br>24,0                               | 704<br>24,0                               |
| 5AGXB5  |   |   |   |            | 544<br>24,0                               | 704<br>36,0                               |
| 5AGXB7  |   |   |   |            | 544<br>24,0                               | 704<br>36,0                               |
| 5AGTC3  | 336<br>3,4                              |   | 416<br>3,4                              | 320<br>3,4 |   |   |
| 5AGTC7  |   |   | 384<br>6,8                              | 320<br>3,4 | 544<br>6,12                               |   |
| 5AGTD3  |   |   | 384<br>6,8                              | 320<br>3,4 | 544<br>6,12                               | 704<br>6,12                               |
| 5AGTD7  |   |   |   |            | 544<br>6,12                               | 704<br>6,20                               |
| 5AGZE1  |   | 342<br>12                               |   |            | 414<br>24                                 |   |
| 5AGZE3  |   | 342<br>12                               |   |            | 414<br>24                                 |   |
| 5AGZE5  |   |   |   |            | 534<br>24                                 | 674<br>36                                 |
| 5AGZE7  |   |   |   |            | 534<br>24                                 | 674<br>36                                 |

<sup>1</sup>All data is correct at the time of printing, and may be subject to change without prior notice. For the latest information, please visit [www.altera.com](http://www.altera.com).

**636**  
**8,0** For Arria V GX and GT devices, values on top indicate available user I/O pins; for Arria V GX and GT, values at the bottom indicate the 6.5536 Gbps and 10.3125 Gbps transceiver count. One pair of 10 Gbps transceiver channels can be configured as three 6 Gbps transceiver channels. For Arria V GZ device, values on top indicate available user I/O pins; values at the bottom indicate the 12.5 Gbps transceiver count.

-  Vertical migration (same V<sub>CC</sub>, GND, ISP, and input pins). I/O pins can be migrated across device variants indicated with vertical migration lines of the same color. For vertical migration, the number of user I/Os may be less than the number stated in the table.
-  Vertical migration is possible only if you use up to 320 I/O pins, up to nine 6.5536 Gbps transceiver count (for Arria V GX devices), and up to four 10.3125 Gbps transceiver count (for Arria V GT devices).

| Arria V SX and ST SoCs (1.1 V) <sup>1</sup> |   |   |   |
|---|---|---|---|
| FBGA (F)                                    |   |   |   |
|   | 896 pin<br>31 x 31 (mm)<br>1.0-mm pitch | 1,152 pin<br>35 x 35 (mm)<br>1.0-mm pitch | 1,517 pin<br>40 x 40 (mm)<br>1.0-mm pitch |
| 5ASXB3                                      | 178, 208<br>12+0                        | 350, 208<br>18+0                          | 528, 208<br>30+0                          |
| 5ASXB5                                      | 178, 208<br>12+0                        | 350, 208<br>18+0                          | 528, 208<br>30+0                          |
| 5ASTD3                                      | 178, 208<br>12+4                        | 350, 208<br>18+8                          | 528, 208<br>30+16                         |
| 5ASTD5                                      | 178, 208<br>12+4                        | 350, 208<br>18+8                          | 528, 208<br>30+16                         |

<sup>1</sup>All data is correct at the time of printing, and may be subject to change without prior notice. For the latest information, please visit [www.altera.com](http://www.altera.com).

636, 216  
8+0

Values on top indicate available FPGA user I/O pins and HPS I/O pins; values at the bottom indicate the 6.5536 Gbps plus 10.3125 Gbps transceiver count.

Vertical migration (same V<sub>CC</sub>, GND, ISP, and input pins). For vertical migration, the number of user I/Os may be less than the number stated in the table.

|                            |  | Maximum Resource Count for Cyclone® V E FPGAs (1.1 V) <sup>1</sup>  |        |         |         |         |
|----------------------------|--|---|--------|---------|---------|---------|
|                            |  | 5CEA2   | 5CEA4  | 5CEA5   | 5CEA7   | 5CEA9   |
| Resources                  | ALMs   | 9,434   | 18,480 | 29,080  | 56,480  | 113,560 |
|                            | LEs (K)  | 25  | 49     | 77      | 149.5   | 301     |
|                            | Registers  | 37,736  | 73,920 | 116,320 | 225,920 | 454,240 |
|                            | M10K memory blocks                                 | 176   | 308    | 446     | 686     | 1,220   |
|                            | M10K memory (Kb)                                   | 1,760   | 3,080  | 4,460   | 6,860   | 12,200  |
|                            | MLAB memory (Kb)                                   | 196   | 303    | 424     | 836     | 1,717   |
|                            | Variable-precision DSP blocks                      | 25  | 66     | 150     | 156     | 342     |
|                            | 18 x 18 multipliers                                | 50  | 132    | 300     | 312     | 684     |
| Architectural Features     | Global clock networks                              | 16  |        |         |         |         |
|                            | PLLs   | 4   | 4      | 6       | 6       | 6       |
|                            | Design security                                    | ✓   |        |         |         |         |
| I/O Features               | I/O voltage levels supported (V)                   | 1.1, 1.2, 1.5, 1.8, 2.5, 3.3  |        |         |         |         |
|                            | I/O standards supported                            | LVTTTL, LVCMOS, PCI, PCI-X, LVDS, mini-LVDS, RSDS, LVPECL, Differential SSTL-15, Differential SSTL-18, Differential SSTL-2, Differential HSTL-12, Differential HSTL-15, Differential HSTL-18, SSTL-15 (I and II), SSTL-18 (I and II), SSTL-2 (I and II), 1.2 V HSTL (I and II), 1.5 V HSTL (I and II), 1.8 V HSTL (I and II), HiSpi, SLVS, Sub-LVDS |        |         |         |         |
|                            | LVDS channels, 875 Mbps receive, 840 Mbps transmit | 56  | 56     | 60      | 120     | 120     |
|                            | Embedded DPA circuitry                             | –   |        |         |         |         |
|                            | OCT  | Series and differential   |        |         |         |         |
|                            | Programmable drive strength                        | ✓   |        |         |         |         |
|                            | PCIe hard IP blocks                                | –   |        |         |         |         |
|                            | Hard memory controllers <sup>2</sup>               | 1   | 1      | 2       | 2       | 2       |
| External Memory Interfaces | Memory devices supported                           | DDR3, DDR2, LPDDR2  |        |         |         |         |

<sup>1</sup>All data is correct at the time of printing, and may be subject to change without prior notice. For the latest information, please visit [www.altera.com](http://www.altera.com).

<sup>2</sup>With 16 and 32 bit ECC support.

|                            |  | Maximum Resource Count for Cyclone V GX FPGAs (1.1 V) <sup>1</sup>  |        |         |         |         |
|----------------------------|--|---|--------|---------|---------|---------|
|                            |  | 5CGXC3  | 5CGXC4 | 5CGXC5  | 5CGXC7  | 5CGXC9  |
| Resources                  | ALMs   | 11,900  | 18,868 | 29,080  | 56,480  | 113,560 |
|                            | LEs (K)  | 31.5  | 50     | 77      | 149.5   | 301     |
|                            | Registers  | 47,600  | 75,472 | 116,320 | 225,920 | 454,240 |
|                            | M10K memory blocks                                 | 119   | 250    | 446     | 686     | 1,220   |
|                            | M10K memory (Kb)                                   | 1,190   | 2,500  | 4,460   | 6,860   | 12,200  |
|                            | MLAB memory (Kb)                                   | 159   | 295    | 424     | 836     | 1,717   |
|                            | Variable-precision DSP blocks                      | 51  | 70     | 150     | 156     | 342     |
|                            | 18 x 18 multipliers                                | 102   | 140    | 300     | 312     | 684     |
| Architectural Features     | Global clock networks                              | 16  |        |         |         |         |
|                            | PLLs <sup>2</sup>                                  | 4   | 6      | 6       | 7       | 8       |
|                            | Design security                                    | ✓   |        |         |         |         |
| I/O Features               | I/O voltage levels supported (V)                   | 1.1, 1.2, 1.5, 1.8, 2.5, 3.3  |        |         |         |         |
|                            | I/O standards supported                            | LVTTTL, LVCMOS, PCI, PCI-X, LVDS, mini-LVDS, RSDS, LVPECL, Differential SSTL-15, Differential SSTL-18, Differential SSTL-2, Differential HSTL-12, Differential HSTL-15, Differential HSTL-18, SSTL-15 (I and II), SSTL-18 (I and II), SSTL-2 (I and II), 1.2 V HSTL (I and II), 1.5 V HSTL (I and II), 1.8 V HSTL (I and II), HiSpi, SLVS, Sub-LVDS |        |         |         |         |
|                            | LVDS channels, 875 Mbps receive, 840 Mbps transmit | 52  | 84     | 84      | 120     | 140     |
|                            | Embedded DPA circuitry                             | -   |        |         |         |         |
|                            | OCT  | Series and differential   |        |         |         |         |
|                            | Programmable drive strength                        | ✓   |        |         |         |         |
|                            | Transceiver count (3.125 Gbps)                     | 3   | 6      | 6       | 9       | 12      |
|                            | PCIe hard IP blocks (Gen1 x4)                      | 1   | 2      | 2       | 2       | 2       |
|                            | Hard memory controllers <sup>3</sup>               | 1   | 2      | 2       | 2       | 2       |
| External Memory Interfaces | Memory devices supported                           | DDR3, DDR2, LPDDR2  |        |         |         |         |

<sup>1</sup> All data is correct at the time of printing, and may be subject to change without prior notice. For the latest information, please visit [www.altera.com](http://www.altera.com).

<sup>2</sup> The PLL count includes general-purpose fractional PLLs and transceiver fractional PLLs.

<sup>3</sup> With 16 and 32 bit ECC support.

|                                      |  | Maximum Resource Count for Cyclone V GT FPGAs (1.1 V) <sup>1</sup>  |         |         |
|--------------------------------------|--|---|---------|---------|
|                                      |  | 5CGTD5  | 5CGTD7  | 5CGTD9  |
| Resources                            | ALMs   | 29,080  | 56,480  | 113,560 |
|                                      | LEs (K)  | 77  | 149.5   | 301     |
|                                      | Registers  | 116,320   | 225,920 | 454,240 |
|                                      | M10K memory blocks                                 | 446   | 686     | 1,220   |
|                                      | M10K memory (Kb)                                   | 4,460   | 6,860   | 12,200  |
|                                      | MLAB memory (Kb)                                   | 424   | 836     | 1,717   |
|                                      | Variable-precision DSP blocks                      | 150   | 156     | 342     |
|                                      | 18 x 18 multipliers                                | 300   | 312     | 684     |
| Architectural Features               | Global clock networks                              | 16  |         |         |
|                                      | PLLs <sup>2</sup>                                  | 6   | 7       | 8       |
|                                      | Design security                                    | ✓   |         |         |
| I/O Features                         | I/O voltage levels supported (V)                   | 1.1, 1.2, 1.5, 1.8, 2.5, 3.3  |         |         |
|                                      | I/O standards supported                            | LLVTTL, LVCMOS, PCI, PCI-X, LVDS, mini-LVDS, RSDS, LVPECL, Differential SSTL-15, Differential SSTL-18, Differential SSTL-2, Differential HSTL-12, Differential HSTL-15, Differential HSTL-18, SSTL-15 (I and II), SSTL-18 (I and II), SSTL-2 (I and II), 1.2 V HSTL (I and II), 1.5 V HSTL (I and II), 1.8 V HSTL (I and II), HiSpi, SLVS, Sub-LVDS |         |         |
|                                      | LVDS channels, 875 Mbps receive, 840 Mbps transmit | 84  | 120     | 140     |
|                                      | Embedded DPA circuitry                             | –   |         |         |
|                                      | OCT  | Series and differential   |         |         |
|                                      | Programmable drive strength                        | ✓   |         |         |
|                                      | Transceiver count (6.144 Gbps) <sup>4</sup>        | 6   | 9       | 12      |
|                                      | PCIe hard IP blocks (Gen2 x1, x2, and x4, Gen1 x4) | 2   | 2       | 2       |
| Hard memory controllers <sup>3</sup> | 2  | 2   | 2       |         |
| External Memory Interfaces           | Memory devices supported                           | DDR3, DDR2, LPDDR2  |         |         |

<sup>1</sup> All data is correct at the time of printing, and may be subject to change without prior notice. For the latest information, please visit [www.altera.com](http://www.altera.com).

<sup>2</sup> The PLL count includes general-purpose fractional PLLs and transceiver fractional PLLs.

<sup>3</sup> With 16 and 32 bit ECC support.

<sup>4</sup> Automotive Grade GT comes with 5 Gbps transceiver.

|                            |  | Maximum Resource Count for Cyclone V SE SoCs (1.1 V) <sup>1</sup>   |                |                |                |
|----------------------------|--|---|----------------|----------------|----------------|
|                            |  | 5CSEA2  | 5CSEA4         | 5CSEA5         | 5CSEA6         |
| Resources                  | ALMs   | 9,434   | 15,094         | 32,075         | 41,509         |
|                            | LEs (K)  | 25  | 40             | 85             | 110            |
|                            | Registers  | 37,736  | 60,376         | 128,300        | 166,036        |
|                            | M10K memory blocks                                 | 140   | 270            | 397            | 557            |
|                            | M10K memory (Kb)                                   | 1,400   | 2,700          | 3,972          | 5,570          |
|                            | MLAB memory (Kb)                                   | 138   | 231            | 480            | 621            |
|                            | Variable-precision DSP blocks                      | 36  | 58             | 87             | 112            |
|                            | 18 x 18 multipliers                                | 72  | 116            | 174            | 224            |
| Architectural Features     | Processor cores (ARM Cortex-A9)                    | Single or dual  | Single or dual | Single or dual | Single or dual |
|                            | Global clock networks                              | 16  |                |                |                |
|                            | PLLs <sup>2</sup> (FPGA)                           | 4   | 5              | 6              | 6              |
|                            | PLLs <sup>2</sup> (HPS)                            | 3   | 3              | 3              | 3              |
|                            | Design security                                    | ✓   |                |                |                |
| I/O Features               | I/O voltage levels supported (V)                   | 1.1, 1.2, 1.5, 1.8, 2.5, 3.3  |                |                |                |
|                            | I/O standards supported                            | LVTTTL, LVCMOS, PCI, PCI-X, LVDS, mini-LVDS, RSDS, LVPECL, Differential SSTL-15, Differential SSTL-18, Differential SSTL-2, Differential HSTL-12, Differential HSTL-15, Differential HSTL-18, SSTL-15 (I and II), SSTL-18 (I and II), SSTL-2 (I and II), 1.2 V HSTL (I and II), 1.5 V HSTL (I and II), 1.8 V HSTL (I and II), HiSpi, SLVS, Sub-LVDS |                |                |                |
|                            | LVDS channels, 875 Mbps receive, 840 Mbps transmit | 35  | 35             | 72             | 72             |
|                            | Embedded DPA circuitry                             | -   |                |                |                |
|                            | OCT  | Series and differential   |                |                |                |
|                            | Programmable drive strength                        | ✓   |                |                |                |
|                            | PCIe hard IP blocks                                | -   |                |                |                |
|                            | GPIOs (FPGA)                                       | 145   | 145            | 288            | 288            |
|                            | GPIOs (HPS)  | 181   | 181            | 181            | 181            |
|                            | Hard memory controllers <sup>3</sup> (FPGA)        | 1   | 1              | 1              | 1              |
|                            | Hard memory controllers <sup>3</sup> (HPS)         | 1   | 1              | 1              | 1              |
| External Memory Interfaces | Memory devices supported                           | DDR3, DDR2, LPDDR2  |                |                |                |

<sup>1</sup>All data is correct at the time of printing, and may be subject to change without prior notice. For the latest information, please visit [www.altera.com](http://www.altera.com).

<sup>2</sup>The PLL count includes general-purpose fractional PLLs and transceiver fractional PLLs.

<sup>3</sup>With 16 and 32 bit ECC support.



|  |  | Maximum Resource Count for Cyclone V SX SoCs (1.1 V) <sup>1</sup>   |        |         |         |
|--|--|---|--------|---------|---------|
|  |  | 5CSXC2  | 5CSXC4 | 5CSXC5  | 5CSXC6  |
| Resources                                  | ALMs   | 9,434   | 15,094 | 32,075  | 41,509  |
|  | LEs (K)  | 25  | 40     | 85      | 110     |
|  | Registers  | 37,736  | 60,376 | 128,300 | 166,036 |
|  | M10K memory blocks                                 | 140   | 270    | 397     | 557     |
|  | M10K memory (Kb)                                   | 1,400   | 2,700  | 3,972   | 5,570   |
|  | MLAB memory (Kb)                                   | 138   | 231    | 480     | 621     |
|  | Variable-precision DSP blocks                      | 36  | 58     | 87      | 112     |
|  | 18 x 18 multipliers                                | 72  | 116    | 174     | 224     |
| Architectural Features                     | Processor cores (ARM Cortex-A9)                    | Dual  | Dual   | Dual    | Dual    |
|  | Global clock networks                              | 16  |        |         |         |
|  | PLLs <sup>2</sup> (FPGA)                           | 4   | 5      | 6       | 6       |
|  | PLLs <sup>2</sup> (HPS)                            | 3   | 3      | 3       | 3       |
|  | Design security                                    | ✓   |        |         |         |
| I/O Features                               | I/O voltage levels supported (V)                   | 1.1, 1.2, 1.5, 1.8, 2.5, 3.3  |        |         |         |
|  | I/O standards supported                            | LVTTTL, LVCMOS, PCI, PCI-X, LVDS, mini-LVDS, RSDS, LVPECL, Differential SSTL-15, Differential SSTL-18, Differential SSTL-2, Differential HSTL-12, Differential HSTL-15, Differential HSTL-18, SSTL-15 (I and II), SSTL-18 (I and II), SSTL-2 (I and II), 1.2 V HSTL (I and II), 1.5 V HSTL (I and II), 1.8 V HSTL (I and II), HiSpi, SLVS, Sub-LVDS |        |         |         |
|  | LVDS channels, 875 Mbps receive, 840 Mbps transmit | 35  | 35     | 72      | 72      |
|  | Embedded DPA circuitry                             | -   |        |         |         |
|  | OCT  | Series and differential   |        |         |         |
|  | Programmable drive strength                        | ✓   |        |         |         |
|  | Transceiver count (3.125 Gbps)                     | 6   | 6      | 9       | 9       |
|  | PCIe hard IP blocks (Gen1 x4)                      | 2   | 2      | 2       | 2       |
|  | GPIOs (FPGA)                                       | 145   | 145    | 288     | 288     |
|  | GPIOs (HPS)  | 181   | 181    | 181     | 181     |
|  | Hard memory controllers <sup>3</sup> (FPGA)        | 1   | 1      | 1       | 1       |
| Hard memory controllers <sup>3</sup> (HPS) | 1  | 1   | 1      | 1       |         |
| External Memory Interfaces                 | Memory devices supported                           | DDR3, DDR2, LPDDR2  |        |         |         |

<sup>1</sup> All data is correct at the time of printing, and may be subject to change without prior notice. For the latest information, please visit [www.altera.com](http://www.altera.com).

<sup>2</sup> The PLL count includes general-purpose fractional PLLs and transceiver fractional PLLs.















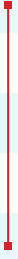

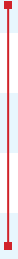

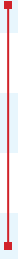

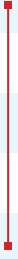







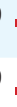
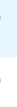
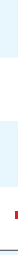





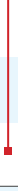

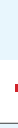





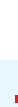

<sup>3</sup> With 16 and 32 bit ECC support.

|                            |  | Maximum Resource Count for Cyclone V ST SoCs (1.1 V) <sup>1</sup>   |         |
|----------------------------|--|---|---------|
|                            |  | 5CSTD5  | 5CSTD6  |
| Resources                  | ALMs   | 32,075  | 41,509  |
|                            | LEs (K)  | 85  | 110     |
|                            | Registers  | 128,300   | 166,036 |
|                            | M10K memory blocks                                 | 397   | 557     |
|                            | M10K memory (Kb)                                   | 3,972   | 5,570   |
|                            | MLAB memory (Kb)                                   | 480   | 621     |
|                            | Variable-precision DSP blocks                      | 87  | 112     |
|                            | 18 x 18 multipliers                                | 174   | 224     |
| Architectural Features     | Processor cores (ARM Cortex-A9)                    | Dual  | Dual    |
|                            | Global clock networks                              | 16  |         |
|                            | PLLs <sup>2</sup> (FPGA)                           | 6   | 6       |
|                            | PLLs <sup>2</sup> (HPS)                            | 3   | 3       |
|                            | Design security                                    | ✓   |         |
| I/O Features               | I/O voltage levels supported (V)                   | 1.1, 1.2, 1.5, 1.8, 2.5, 3.3  |         |
|                            | I/O standards supported                            | LLVTTL, LVCMOS, PCI, PCI-X, LVDS, mini-LVDS, RSDS, LVPECL, Differential SSTL-15, Differential SSTL-18, Differential SSTL-2, Differential HSTL-12, Differential HSTL-15, Differential HSTL-18, SSTL-15 (I and II), SSTL-18 (I and II), SSTL-2 (I and II), 1.2 V HSTL (I and II), 1.5 V HSTL (I and II), 1.8 V HSTL (I and II), HiSpi, SLVS, Sub-LVDS |         |
|                            | LVDS channels, 875 Mbps receive, 840 Mbps transmit | 72  | 72      |
|                            | Embedded DPA circuitry                             | -   |         |
|                            | OCT  | Series and differential   |         |
|                            | Programmable drive strength                        | ✓   |         |
|                            | Transceiver count (5 Gbps)                         | 9   | 9       |
|                            | PCIe hard IP blocks (Gen2 x1,x2, and x4, Gen1 x4)  | 2   | 2       |
|                            | GPIOs (FPGA)                                       | 288   | 288     |
|                            | GPIOs (HPS)  | 181   | 181     |
|                            | Hard memory controllers <sup>3</sup> (FPGA)        | 1   | 1       |
|                            | Hard memory controllers <sup>3</sup> (HPS)         | 1   | 1       |
| External Memory Interfaces | Memory devices supported                           | DDR3, DDR2, LPDDR2  |         |

<sup>1</sup>All data is correct at the time of printing, and may be subject to change without prior notice. For the latest information, please visit [www.altera.com](http://www.altera.com).

<sup>2</sup>The PLL count includes general-purpose fractional PLLs and transceiver fractional PLLs.

<sup>3</sup>With 16 and 32 bit ECC support.

| Cyclone V E, GX, and GT FPGAs (1.1 V) <sup>1</sup> |  |  |   |   |  |   |  |  |   |   |
|--|--|--|---|---|--|---|--|--|---|---|
|  | MBGA (M)   |  |   | UBGA (U)  |  | FBGA (F)  |  |  |   |   |
|  | 301 pin<br>11 x 11 (mm)<br>0.5-mm pitch  | 383 pin<br>13 x 13 (mm)<br>0.5-mm pitch  | 484 pin<br>15 x 15 (mm)<br>0.5-mm pitch | 324 pin<br>15 x 15 (mm)<br>0.8-mm pitch   | 484 pin<br>19 x 19 (mm)<br>0.8-mm pitch  | 256 pin<br>17 x 17 (mm)<br>1.0-mm pitch   | 484 pin<br>23 x 23 (mm)<br>1.0-mm pitch  | 672 pin<br>27 x 27 (mm)<br>1.0-mm pitch  | 896 pin<br>31 x 31 (mm)<br>1.0-mm pitch   | 1,152 pin<br>35 x 35 (mm)<br>1.0-mm pitch |
| 5CEA2  |  | 223       |   | 176  | 224         | 128  | 224         |  |   |   |
| 5CEA4  |  | 223  |   | 176  | 224  | 128  | 224         |  |   |   |
| 5CEA5  |  | 175       |   |   | 224         |   | 240         |  |   |   |
| 5CEA7  |  |  | 240                                     |   | 240         |   | 240         | 336         | 480          |   |
| 5CEA9  |  |  |   |   | 240         |   | 224         | 336         | 480          |   |
| 5CGXC3   |  |  |   | 144<br>3  | 208<br>3   |   | 208<br>3   |  |   |   |
| 5CGXC4   | 129<br>4  | 175<br>6  |   |   | 224<br>6   |   | 240<br>6   | 336<br>6   |   |   |
| 5CGXC5   | 129<br>4  | 175<br>6  |   |   | 224<br>6   |   | 240<br>6   | 336<br>6   |   |   |
| 5CGXC7   |  |  | 240<br>3                                |   | 240<br>6   |   | 240<br>6   | 336<br>9   | 480<br>9    |   |
| 5CGXC9   |  |  |   |   | 240<br>5   |   | 224<br>6   | 336<br>9   | 480<br>12   | 560<br>12                                 |
| 5CGTD5   | 129<br>4   | 175<br>6   |   |   | 224<br>6  |   | 240<br>6  | 336<br>6  |   |   |
| 5CGTD7   |  |  | 240<br>3                                |   | 240<br>6  |   | 240<br>6  | 336<br>9  | 480<br>9   |   |
| 5CGTD9   |  |  |   |   | 240<br>5  |   | 224<br>6  | 336<br>9  | 480<br>12  | 560<br>12                                 |

<sup>1</sup>All data is correct at the time of printing, and may be subject to change without prior notice. For the latest information, please visit [www.altera.com](http://www.altera.com).

 Values on top indicate available user I/O pins; values at the bottom indicate the 3.125 Gbps, 5 Gbps, or 6.144 Gbps transceiver count.

 Vertical migration (same V<sub>CC</sub>, GND, ISP, and input pins). For vertical migration, the number of user I/Os may be less than the number stated in the table.

| Cyclone V SE, SX, and ST SoCs (1.1 V) <sup>1</sup> |   |   |   |
|--|---|---|---|
|  | UBGA (U)                                |   | FBGA (F)                                |
|  | 484 pin<br>19 x 19 (mm)<br>0.8-mm pitch | 672 pin<br>23 x 23 (mm)<br>0.8-mm pitch | 896 pin<br>31 x 31 (mm)<br>1.0-mm pitch |
| 5CSEA2   | 66, 161<br>0                            | 145, 181<br>0                           |   |
| 5CSEA4   | 66, 161<br>0                            | 145, 181<br>0                           |   |
| 5CSEA5   | 66, 161<br>0                            | 145, 181<br>0                           | 288, 181<br>0                           |
| 5CSEA6   | 66, 161<br>0                            | 145, 181<br>0                           | 288, 181<br>0                           |
| 5CSXC2   |   | 145, 181<br>6                           |   |
| 5CSXC4   |   | 145, 181<br>6                           |   |
| 5CSXC5   |   | 145, 181<br>9                           | 288, 181<br>9                           |
| 5CSXC6   |   | 145, 181<br>9                           | 288, 181<br>9                           |
| 5CSTD5   |   |   | 288, 181<br>9                           |
| 5CSTD6   |   |   | 288, 181<br>9                           |

<sup>1</sup> All data is correct at the time of printing, and may be subject to change without prior notice. For the latest information, please visit [www.altera.com](http://www.altera.com).

636, 161  
12 Values on top indicate available FPGA user I/O pins and HPS I/O pins; values at the bottom indicate the 3.125 Gbps or 5 Gbps transceiver count.

Vertical migration (same V<sub>CC</sub>, GND, ISP, and input pins). For vertical migration, the number of user I/Os may be less than the number stated in the table.

|                          |  | Maximum Resource Count for Stratix IV GT FPGAs (0.95 V) <sup>1</sup>   |          |           |           |           |           |
|--------------------------|--|--|----------|-----------|-----------|-----------|-----------|
|                          |  | EP4S40G2   | EP4S40G5 | EP4S100G2 | EP4S100G3 | EP4S100G4 | EP4S100G5 |
| Resources                | ALMs   | 91,200   | 212,480  | 91,200    | 116,480   | 141,440   | 212,480   |
|                          | LEs (K)  | 228  | 531      | 228       | 291       | 354       | 531       |
|                          | Registers <sup>2</sup>                                       | 182,400  | 424,960  | 182,400   | 232,960   | 282,880   | 424,960   |
|                          | M9K memory blocks  | 1,235  | 1,280    | 1,235     | 936       | 1,248     | 1,280     |
|                          | M144K memory blocks  | 22   | 64       | 22        | 36        | 48        | 64        |
|                          | MLAB memory (Kb)   | 2,850  | 6,640    | 2,850     | 3,640     | 4,420     | 6,640     |
|                          | Embedded memory (Kb)   | 14,283   | 20,736   | 14,283    | 13,608    | 18,144    | 20,736    |
|                          | 18 x 18 multipliers  | 1,288  | 1,024    | 1,288     | 832       | 1,024     | 1,024     |
| Architectural Features   | Global clock networks  | 16   |          |           |           |           |           |
|                          | Regional clock networks                                      | 64   | 88       | 64        | 88        | 88        | 88        |
|                          | Periphery clock networks                                     | 88   | 112      | 88        | 112       | 112       | 112       |
|                          | PLLs   | 8  | 8        | 8         | 12        | 12        | 12        |
|                          | Design security  | ✓  |          |           |           |           |           |
|                          | Others   | Plug & Play Signal Integrity, Programmable Power Technology  |          |           |           |           |           |
| I/O Features             | I/O voltage levels supported (V)                             | 1.2, 1.5, 1.8, 2.5, 3.3 <sup>3</sup>   |          |           |           |           |           |
|                          | I/O standards supported                                      | LVTTTL, LVCMOS, PCI, PCI-X, LVDS, mini-LVDS, RSDS, LVPECL, Differential SSTL-15, Differential SSTL-18, Differential SSTL-2, Differential HSTL-12, Differential HSTL-15, Differential HSTL-18, SSTL-15 (I and II), SSTL-18 (I and II), SSTL-2 (I and II), 1.2 V HSTL (I and II), 1.5 V HSTL (I and II), 1.8 V HSTL (I and II) |          |           |           |           |           |
|                          | Emulated LVDS channels, 1,100 Mbps                           | 192  | 256      | 192       | 256       | 256       | 256       |
|                          | LVDS channels, 1,600 Mbps (receive/transmit)                 | 46/46  |          |           |           |           |           |
|                          | Embedded DPA circuitry                                       | ✓  |          |           |           |           |           |
|                          | OCT  | Series, parallel, and differential   |          |           |           |           |           |
|                          | Transceiver count <sup>4</sup> (11.3 Gbps/8.5 Gbps/6.5 Gbps) | 12/12/12   | 12/12/12 | 24/0/12   | 24/8/16   | 24/8/16   | 32/0/16   |
|                          | PCIe hard IP blocks  | 2  | 2        | 2         | 4         | 4         | 4         |
| Memory devices supported | DDR3, DDR2, DDR, QDR II, QDR II+, RDRAM 2, SDR               |  |          |           |           |           |           |

<sup>1</sup> Available in industrial temperatures only (0°C to 100°C).

<sup>2</sup> This is the base core logic register count. The ALM can support three registers when used in LUTREG mode, which increases total register count by an additional 50 percent.

<sup>3</sup> 3.3 V compliant, requires a 3 V power supply.

<sup>4</sup> The total transceiver count is the sum of 11.3 Gbps plus 8.5 Gbps plus 6.5 Gbps transceivers.

|                          |  | Maximum Resource Count for Stratix IV GX FPGAs (0.9 V)   |           |           |           |           |                    |           |
|--------------------------|--|--|-----------|-----------|-----------|-----------|--------------------|-----------|
|                          |  | EP4SGX70   | EP4SGX110 | EP4SGX180 | EP4SGX230 | EP4SGX290 | EP4SGX360          | EP4SGX530 |
| Resources                | ALMs   | 29,040   | 42,240    | 70,300    | 91,200    | 116,480   | 141,440            | 212,480   |
|                          | LEs (K)  | 73   | 106       | 176       | 228       | 291       | 354                | 531       |
|                          | Registers <sup>1</sup>                             | 58,080   | 84,480    | 140,600   | 182,400   | 232,960   | 282,880            | 424,960   |
|                          | M9K memory blocks                                  | 462  | 660       | 950       | 1,235     | 936       | 1,248              | 1,280     |
|                          | M144K memory blocks                                | 16   | 16        | 20        | 22        | 36        | 48                 | 64        |
|                          | MLAB memory (Kb)                                   | 908  | 1,320     | 2,197     | 2,850     | 3,640     | 4,420              | 6,640     |
|                          | Embedded memory (Kb)                               | 6,462  | 8,244     | 11,430    | 14,283    | 13,608    | 18,144             | 20,736    |
|                          | 18 x 18 multipliers                                | 384  | 512       | 920       | 1,288     | 832       | 1,040 <sup>2</sup> | 1,024     |
| Architectural Features   | Global clock networks                              | 16   |           |           |           |           |                    |           |
|                          | Regional clock networks                            | 64   | 64        | 64        | 64        | 88        | 88                 | 88        |
|                          | Periphery clock networks                           | 56   | 56        | 88        | 88        | 88        | 88                 | 112       |
|                          | PLLs   | 4  | 4         |           | 8         | 12        | 12                 | 12        |
|                          | Design security                                    | ✓  |           |           |           |           |                    |           |
|                          | Others   | Plug & Play Signal Integrity, Programmable Power Technology  |           |           |           |           |                    |           |
| I/O Features             | I/O voltage levels supported (V)                   | 1.2, 1.5, 1.8, 2.5, 3.3 <sup>4</sup>   |           |           |           |           |                    |           |
|                          | I/O standards supported                            | LVTTTL, LVCMOS, PCI, PCI-X, LVDS, mini-LVDS, RSDS, LVPECL, Differential SSTL-15, Differential SSTL-18, Differential SSTL-2, Differential HSTL-12, Differential HSTL-15, Differential HSTL-18, SSTL-15 (I and II), SSTL-18 (I and II), SSTL-2 (I and II), 1.2 V HSTL (I and II), 1.5 V HSTL (I and II), 1.8 V HSTL (I and II) |           |           |           |           |                    |           |
|                          | Emulated LVDS channels, 1,100 Mbps                 | 128  | 128       | 192       | 192       | 256       | 256                | 256       |
|                          | LVDS channels, 1,600 Mbps (receive/transmit)       | 56/56  | 56/56     | 88/88     | 88/88     | 98/98     | 98/98              | 98/98     |
|                          | Embedded DPA circuitry                             |  |           |           |           |           |                    |           |
|                          | OCT  | Series, parallel, and differential   |           |           |           |           |                    |           |
|                          | Transceiver count (8.5 Gbps/6.5 Gbps) <sup>5</sup> | 16/8   | 16/8      | 24/12     | 24/12     | 32/16     | 32/16              | 32/16     |
|                          | PCIe hard IP blocks                                | 2  | 2         | 2         | 2         | 4         | 4                  | 4         |
| Memory devices supported | DDR3, DDR2, DDR, QDR II, QDR II+, RLDRAM 2, SDR    |  |           |           |           |           |                    |           |

<sup>1</sup> This is the base core logic register count. The ALM can support three registers when used in LUTREG mode, which increases the total register count by an additional 50 percent.

<sup>2</sup> EP4SGX360N has 1,024 18x18 multipliers.

<sup>3</sup> For EP4SGX70D and EP4SGX110D/F devices.

<sup>4</sup> 3.3 V compliant, requires a 3 V power supply.

<sup>5</sup> The total transceiver count is the sum of 8.5 Gbps transceivers plus 6.5 Gbps transceivers.

|                        |  | Maximum Resource Count for Stratix IV E FPGAs (0.9 V)  |          |          |          |
|------------------------|--|--|----------|----------|----------|
|                        |  | EP4SE230   | EP4SE360 | EP4SE530 | EP4SE820 |
| Resources              | ALMs   | 91,200   | 141,440  | 212,480  | 325,220  |
|                        | LEs (K)                                      | 228  | 354      | 531      | 813      |
|                        | Registers <sup>1</sup>                       | 182,400  | 282,880  | 424,960  | 650,440  |
|                        | M9K memory blocks                            | 1,235  | 1,248    | 1,280    | 1,610    |
|                        | M144K memory blocks                          | 22   | 48       | 64       | 60       |
|                        | MLAB memory (Kb)                             | 2,850  | 4,420    | 6,640    | 10,163   |
|                        | Embedded memory (Kb)                         | 14,283   | 18,144   | 20,736   | 23,130   |
|                        | 18 x 18 multipliers                          | 1,288  | 1,040    | 1,024    | 960      |
| Architectural Features | Global clock networks                        | 16   |          |          |          |
|                        | Regional clock networks                      | 64   | 88       | 88       | 88       |
|                        | Periphery clock networks                     | 88   | 88       | 112      | 132      |
|                        | PLLs   | 4  | 12       | 12       | 12       |
|                        | Design security                              | ✓  |          |          |          |
|                        | Others                                       | Programmable Power Technology  |          |          |          |
| I/O Features           | I/O voltage levels supported (V)             | 1.2, 1.5, 1.8, 2.5, 3.3 <sup>2</sup>   |          |          |          |
|                        | I/O standards supported                      | LVTTTL, LVCMOS, PCI, PCI-X, LVDS, mini-LVDS, RSDS, LVPECL, Differential SSTL-15, Differential SSTL-18, Differential SSTL-2, Differential HSTL-12, Differential HSTL-15, Differential HSTL-18, SSTL-15 (I and II), SSTL-18 (I and II), SSTL-2 (I and II), 1.2 V HSTL (I and II), 1.5 V HSTL (I and II), 1.8 V HSTL (I and II) |          |          |          |
|                        | Emulated LVDS channels, 1,100 Mbps           | 128  | 256      | 256      | 288      |
|                        | LVDS channels, 1,600 Mbps (receive/transmit) | 56/56  | 88/88    | 112/112  | 132/132  |
|                        | Embedded DPA circuitry                       | ✓  |          |          |          |
|                        | OCT  | Series, parallel, and differential   |          |          |          |
|                        | Memory devices supported                     | DDR3, DDR2, DDR, QDR II, QDR II+, RDRAM 2, SDR   |          |          |          |

<sup>1</sup>This is the base core logic register count. The ALM can support three registers when used in LUTREG mode, which can increase the total register count by an additional 50 percent.

<sup>2</sup> 3.3 V compliant, requires a 3 V power supply.

|   |           | FBGA (F) <sup>1</sup>                   |   |   |   |   |   |
|---|-----------|---|---|---|---|---|---|
|   |           | 780 pin<br>29 x 29 (mm)<br>1.0-mm pitch | 1,152 pin<br>35 x 35 (mm)<br>1.0-mm pitch | 1,152 pin<br>35 x 35 (mm)<br>1.0-mm pitch | 1,517 pin<br>40 x 40 (mm)<br>1.0-mm pitch | 1,760 pin<br>42.5 x 42.5 (mm)<br>1.0-mm pitch | 1,932 pin<br>45 x 45 (mm)<br>1.0-mm pitch |
| Stratix IV GT<br>FPGAs (0.95V)              | EP4S40G2  |   |   |   | 646<br>12+12+12                           |   |   |
|   | EP4S40G5  |   |   |   | 646 <sup>4</sup><br>12+12+12              |   |   |
|   | EP4S100G2 |   |   |   | 646<br>24+0+12                            |   |   |
|   | EP4S100G3 |   |   |   |   |   | 769<br>24+8+16                            |
|   | EP4S100G4 |   |   |   |   |   | 769<br>24+8+16                            |
|   | EP4S100G5 |   |   |   | 646 <sup>4</sup><br>24+0+12               |   | 769<br>32+0+16                            |
| Stratix IV GX<br>FPGAs (0.9 V) <sup>2</sup> | EP4SGX70  | 368<br>8+0                              |   | 480<br>16+8                               |   |   |   |
|   | EP4SGX110 | 368<br>8+0                              | 368<br>16+0                               | 480<br>16+8                               |   |   |   |
|   | EP4SGX180 | 368<br>8+0                              | 560<br>16+0                               | 560<br>16+8                               | 736<br>24+12                              |   |   |
|   | EP4SGX230 | 368<br>8+0                              | 560<br>16+0                               | 560<br>16+8                               | 736<br>24+12                              |   |   |
|   | EP4SGX290 | 288 <sup>3</sup><br>16+0                | 560<br>16+0                               | 560<br>16+8                               | 736<br>24+12                              | 864<br>24+12                                  | 904<br>32+16                              |
|   | EP4SGX360 | 288 <sup>3</sup><br>16+0                | 560<br>16+0                               | 560<br>16+8                               | 736<br>24+12                              | 864<br>24+12                                  | 904<br>32+16                              |
|   | EP4SGX530 |   |   | 560 <sup>4</sup><br>16+8                  | 736 <sup>4</sup><br>24+12                 | 864<br>24+12                                  | 904<br>32+16                              |
| Stratix IV E<br>FPGAs                       | EP4SE820  |   | 736 <sup>4</sup>                          |   | 960 <sup>4</sup>                          | 1,104   |   |
|   | EP4SE530  |   | 736 <sup>4</sup>                          |   | 960 <sup>4</sup>                          | 960   |   |
|   | EP4SE360  | 480 <sup>2</sup>                        | 736                                       |   |   |   |   |
|   | EP4SE230  | 480                                     |   |   |   |   |   |

<sup>1</sup>FineLine ball grid array.

<sup>2</sup>I/O count does not include dedicated clock inputs that can be used as data inputs.

<sup>3</sup>Hybrid package (flip chip) FBGA: 35 x 35 (mm) 1.0-mm pitch.

<sup>4</sup>Hybrid package (flip chip) FBGA: 42.5 x 42.5 (mm) 1.0-mm pitch.

 Values on top indicate available user I/O pins; values on bottom indicate the 11.3 Gbps plus 8.5 Gbps plus 6.5 Gbps transceiver count.

 Values on top indicate available user I/O pins; values at the bottom indicate the 8.5 Gbps plus 6.5 Gbps transceiver count.

 Number indicates available user I/O pins.

 Vertical migration (same V<sub>CC</sub>, GND, ISP, and input pins). For vertical migration, the number of user I/Os may be less than the number stated in the table.

Stratix series devices are offered in commercial and industrial temperatures and RoHS-compliant packages. Stratix IV GT devices are only offered in industrial temperatures (0°C to 100°C).



|  |  | Maximum Resource Count for Arria II GZ FPGAs (0.9 V)  |           |           |
|--|--|---|-----------|-----------|
|  |  | EP2AGZ225   | EP2AGZ300 | EP2AGZ350 |
| Resources                                    | ALMs   | 89,600  | 119,200   | 139,400   |
|  | LEs (K)                                      | 224   | 298       | 349       |
|  | Registers                                    | 179,200   | 238,400   | 278,800   |
|  | M9K memory blocks                            | 1,235   | 1,248     | 1,248     |
|  | M144K memory blocks                          | 0   | 24        | 36        |
|  | MLAB memory (Kb)                             | 2,850   | 4,420     | 4,420     |
|  | Embedded memory (Kb)                         | 11,115  | 14,688    | 16,416    |
|  | 18 x 18 multipliers                          | 800   | 920       | 1,040     |
| Architectural Features                       | Global clock networks                        | 16  |           |           |
|  | Regional clock networks                      | 64  | 88        | 88        |
|  | Periphery clock networks                     | 88  |           |           |
|  | PLLs   | 8   | 8         | 8         |
|  | Design security                              | ✓   |           |           |
| I/O Features                                 | I/O voltage levels supported (V)             | 1.2, 1.5, 1.8, 2.5, 3.0   |           |           |
|  | I/O standards supported                      | LVTTTL, LVCMOS, PCI, PCI-X, LVDS, mini-LVDS, RSDS, LVPECL, Differential SSTL-15, Differential SSTL-18, Differential SSTL-2, Differential HSTL-12, Differential HSTL-15 (I and II), Differential HSTL-18, SSTL-15 (I and II), SSTL-18 (I and II), 1.2 V HSTL (I and II), SSTL-2 (I and II), 1.5 V HSTL (I and II), 1.8 V HSTL (I and II) |           |           |
|  | Emulated LVDS channels, 1,152 Mbps           | 184   | 184       | 184       |
|  | LVDS channels, 1,250 Mbps (receive/transmit) | Up to 86  |           |           |
|  | Embedded DPA circuitry                       | ✓   |           |           |
|  | OCT  | Series and differential   |           |           |
|  | Transceiver count (6.375 Gbps)               | Up to 24  |           |           |
| PCIe hard IP blocks (value as 1.1, 2.0, etc) | 1  |   |           |           |
| External Memory Interfaces                   | Memory devices supported                     | DDR3, DDR2, DDR, QDR II, RLDRAM 2, SDR  |           |           |

|                            |  | Maximum Resource Count for Arria II GX FPGAs (0.9 V)   |          |          |           |           |           |
|----------------------------|--|--|----------|----------|-----------|-----------|-----------|
|                            |  | EP2AGX45   | EP2AGX65 | EP2AGX95 | EP2AGX125 | EP2AGX190 | EP2AGX260 |
| Resources                  | ALMs   | 18,050   | 25,300   | 37,470   | 49,640    | 76,120    | 102,600   |
|                            | LEs (K)                                      | 43   | 60       | 89       | 118       | 118       | 244       |
|                            | Registers <sup>1</sup>                       | 36,100   | 50,600   | 74,940   | 99,280    | 152,240   | 205,200   |
|                            | M9K memory blocks                            | 319  | 495      | 612      | 730       | 840       | 950       |
|                            | MLAB memory (Kb)                             | 564  | 791      | 1,171    | 1,551     | 2,379     | 3,206     |
|                            | Embedded memory (Kb)                         | 2,871  | 4,455    | 5,508    | 6,570     | 7,560     | 8,550     |
|                            | 18 x 18 multipliers                          | 232  | 312      | 448      | 576       | 656       | 736       |
| Architectural Features     | Global clock networks                        | 16   |          |          |           |           |           |
|                            | Regional clock networks                      | 48   |          |          |           |           |           |
|                            | Periphery clock networks                     | 50   | 50       | 59       | 59        | 84        | 84        |
|                            | PLLs   | 4  | 4        | 6        | 6         | 6         | 6         |
|                            | Design security                              | ✓  |          |          |           |           |           |
|                            | Others                                       | Plug & Play Signal Integrity   |          |          |           |           |           |
| I/O Features               | I/O voltage levels supported (V)             | 1.2, 1.5, 1.8, 2.5, 3.0, 3.3   |          |          |           |           |           |
|                            | I/O standards supported                      | LVTTTL, LVCMOS, PCI, PCI-X, LVDS, mini-LVDS, RSDS, LVPECL, BLVDS, Differential SSTL-18, Differential SSTL-15, Differential SSTL-2, Differential HSTL-18, Differential HSTL-12, Differential HSTL-15, SSTL-18 (I and II), SSTL-15 (I), SSTL-2 (I and II), 1.8 V HSTL (I and II), 1.5 V HSTL (I and II), 1.2 V HSTL (I and II) |          |          |           |           |           |
|                            | Emulated LVDS channels, 945 Mbps             | 56   | 56       | 64       | 64        | 96        | 96        |
|                            | LVDS channels, 1,250 Mbps (receive/transmit) | 85/84  | 85/84    | 105/104  | 105/104   | 145/144   | 145/144   |
|                            | Embedded DPA circuitry                       | ✓  |          |          |           |           |           |
|                            | OCT  | Series and differential  |          |          |           |           |           |
|                            | Transceiver count (6.375 Gbps)               | 8  | 8        | 12       | 12        | 16        | 16        |
| PCIe hard IP block (Gen1)  | 1  |  |          |          |           |           |           |
| External Memory Interfaces | Memory devices supported                     | DDR3, DDR2, DDR, QDR II  |          |          |           |           |           |

<sup>1</sup> This is the base core logic register count. The ALM can support three registers when used in LUTREG mode, which increases total register count by an additional 50 percent.

Arria II GZ and GX FPGA Series Package and I/O Matrices

| Arria II GX FPGAs (0.9 V) |   |   |   |   |
|---------------------------|---|---|---|---|
|                           | UBGA (U) <sup>1</sup>                   | FBGA (F)                                |   |   |
|                           | 358 pin<br>17 x 17 (mm)<br>0.8-mm pitch | 572 pin<br>25 x 25 (mm)<br>1.0-mm pitch | 780 pin<br>29 x 29 (mm)<br>1.0-mm pitch | 1,152 pin<br>35 x 35 (mm)<br>1.0-mm pitch |
| EP2AGX45                  | 156<br>4                                | 252<br>8                                | 364<br>8                                |   |
| EP2AGX65                  | 156<br>4                                | 252<br>8                                | 364<br>8                                |   |
| EP2AGX95                  |   | 260<br>8                                | 372<br>12                               | 452<br>12                                 |
| EP2AGX125                 |   | 260<br>8                                | 372<br>12                               | 452<br>12                                 |
| EP2AGX190                 |   |   | 372<br>12                               | 612<br>16                                 |
| EP2AGX260                 |   |   | 372<br>12                               | 612<br>16                                 |

<sup>1</sup>Ultra FineLine ball grid array.

726  
24 Values on top indicate available user I/O pins; values at the bottom indicate the 6.375 Gbps transceiver count.

Vertical migration (same V<sub>CC</sub>, GND, ISP, and input pins). For vertical migration, the number of user I/Os may be less than the number stated in the table.

| Arria II GZ FPGAs (0.9 V) |   |   |   |
|---------------------------|---|---|---|
|                           | Hybrid FBGA (H)                         | FBGA (F)                                  |   |
|                           | 780 pin<br>33 x 33 (mm)<br>1.0-mm pitch | 1,152 pin<br>35 x 35 (mm)<br>1.0-mm pitch | 1,517 pin<br>40 x 40 (mm)<br>1.0-mm pitch |
| EP2AGZ225                 |   | 554<br>16                                 | 734<br>24                                 |
| EP2AGZ300                 | 281<br>16                               | 554<br>16                                 | 734<br>24                                 |
| EP2AGZ350                 | 281<br>16                               | 554<br>16                                 | 734<br>24                                 |

636  
12 Values on top indicate available user I/O pins; values at the bottom indicate the 6.375 Gbps transceiver count.

Vertical migration (same V<sub>CC</sub>, GND, ISP, and input pins). For vertical migration, the number of user I/Os may be less than the number stated in the table.

|                            |  | Maximum Resource Count for Cyclone IV GX FPGAs (1.2 V)   |             |                          |          |          |           |           |
|----------------------------|--|--|-------------|--------------------------|----------|----------|-----------|-----------|
|                            |  | EP4CGX15   | EP4CGX22    | EP4CGX30                 | EP4CGX50 | EP4CGX75 | EP4CGX110 | EP4CGX150 |
| Resources                  | LEs (K)  | 14   | 21          | 29                       | 50       | 74       | 109       | 150       |
|                            | M9K memory blocks                                    | 60   | 84          | 120                      | 278      | 462      | 666       | 720       |
|                            | Embedded memory (Kb)                                 | 540  | 756         | 1,080                    | 2,502    | 4,158    | 5,490     | 6,480     |
|                            | 18 x 18 multipliers                                  | 0  | 40          | 80                       | 140      | 198      | 280       | 360       |
| Architectural Features     | Global clock networks                                | 20   | 20          | 20                       | 30       | 30       | 30        | 30        |
|                            | PLLs   | 3  | 4           | 4                        | 8        | 8        | 8         | 8         |
| I/O Features               | I/O voltage levels supported (V)                     | 1.2, 1.5, 1.8, 2.5, 3.3  |             |                          |          |          |           |           |
|                            | I/O standards supported                              | LVTTTL, LVCMOS, PCI, PCI-X, LVDS, mini-LVDS, RSDS, LVPECL, Differential SSTL-15, Differential SSTL-18, Differential SSTL-2, Differential HSTL-12, Differential HSTL-15, Differential HSTL-18, SSTL-15 (I and II), SSTL-18 (I and II), SSTL-2 (I and II), 1.2 V HSTL (I and II), 1.5 V HSTL (I and II), 1.8 V HSTL (I and II) |             |                          |          |          |           |           |
|                            | Emulated LVDS channels                               | 9  | 40          | 40                       | 73       | 73       | 139       | 139       |
|                            | LVDS channels, 840 Mbps (receive/transmit)           | 7/7  | 14/14       | 14/14                    | 49/49    | 49/49    | 59/59     | 59/59     |
|                            | Transceiver count <sup>1</sup> (2.5 Gbps/3.125 Gbps) | 2/0  | 2, 0 / 4, 0 | 4, 0 / 0, 4 <sup>2</sup> | 0, 8     | 0, 8     | 0, 8      | 0, 8      |
|                            | PCIe hard IP blocks (Gen1)                           | 1  |             |                          |          |          |           |           |
| External Memory Interfaces | Memory devices supported                             | DDR2, DDR, SDR   |             |                          |          |          |           |           |

<sup>1</sup> Transceiver performance varies by product line and package offering.

<sup>2</sup> EP4CGX30 supports 3.125 Gbps only in F484 package option.

|                            |                                  | Maximum Resource Count for Cyclone IV E FPGAs  |         |         |         |         |         |         |         |          |
|----------------------------|----------------------------------|--|---------|---------|---------|---------|---------|---------|---------|----------|
|                            |                                  | EP4CE6   | EP4CE10 | EP4CE15 | EP4CE22 | EP4CE30 | EP4CE40 | EP4CE55 | EP4CE75 | EP4CE115 |
| Resources                  | LEs (K)                          | 6  | 10      | 15      | 22      | 29      | 40      | 56      | 75      | 114      |
|                            | M9K memory blocks                | 30   | 46      | 56      | 66      | 66      | 126     | 260     | 305     | 432      |
|                            | Embedded memory (Kb)             | 270  | 414     | 504     | 594     | 594     | 1,134   | 2,340   | 2,745   | 3,888    |
|                            | 18 x 18 multipliers              | 15   | 23      | 56      | 66      | 66      | 116     | 154     | 200     | 266      |
| Architectural Features     | Global clock networks            | 10   | 10      | 20      | 20      | 20      | 20      | 20      | 20      | 20       |
|                            | PLLs                             | 2  | 2       | 4       | 4       | 4       | 4       | 4       | 4       | 4        |
| I/O Features               | I/O voltage levels supported (V) | 1.2, 1.5, 1.8, 2.5, 3.3  |         |         |         |         |         |         |         |          |
|                            | I/O standards supported          | LVTTTL, LVCMOS, PCI, PCI-X, LVDS, mini-LVDS, RSDS, LVPECL, Differential SSTL-15, Differential SSTL-18, Differential SSTL-2, Differential HSTL-12, Differential HSTL-15, Differential HSTL-18, SSTL-15 (I and II), SSTL-18 (I and II), SSTL-2 (I and II), 1.2 V HSTL (I and II), 1.5 V HSTL (I and II), 1.8 V HSTL (I and II) |         |         |         |         |         |         |         |          |
|                            | LVDS channels                    | 66   | 66      | 137     | 52      | 224     | 224     | 160     | 178     | 230      |
| External Memory Interfaces | Memory devices supported         | DDR2, DDR, SDR   |         |         |         |         |         |         |         |          |

| Cyclone IV GX FPGAs (1.2 V)             |   |   |   |   |   |          |
|---|---|---|---|---|---|----------|
| QFN (N) <sup>1</sup>                    | FBGA (F)                                  |   |   |   |   |          |
| 148 pin<br>11 x 11 (mm)<br>0.5-mm pitch | 169 v pin<br>14 x 14 (mm)<br>1.0-mm pitch | 324 pin<br>19 x 19 (mm)<br>1.0-mm pitch | 484 pin<br>23 x 23 (mm)<br>1.0-mm pitch | 672 pin<br>27 x 27 (mm)<br>1.0-mm pitch | 896 pin<br>31 x 31 (mm)<br>1.0-mm pitch |          |
| EP4CGX15                                | 72<br>2                                   | 72<br>2                                 |   |   |   |          |
| EP4CGX22                                |   | 72<br>2                                 | 150<br>4                                |   |   |          |
| EP4CGX30                                |   | 72<br>2                                 | 150<br>4                                | 290<br>4                                |   |          |
| EP4CGX50                                |   |   |   | 290<br>4                                | 310<br>8                                |          |
| EP4CGX75                                |   |   |   | 290<br>4                                | 310<br>8                                |          |
| EP4CGX110                               |   |   |   | 270<br>4                                | 393<br>8                                | 475<br>8 |
| EP4CGX150                               |   |   |   | 270<br>4                                | 393<br>8                                | 475<br>8 |

<sup>1</sup> Quad flat pack no lead.

636  
12 Values on top indicate available user I/O pins; values at the bottom indicate the 2.5 Gbps or 3.125 Gbps transceiver count.

Vertical migration (same V<sub>CC</sub>, GND, ISP, and input pins). For vertical migration, the number of user I/Os may be less than the number stated in the table.

| Cyclone IV E FPGAs (1.0 V and 1.2 V)    |   |   |   |   |                                       |   |   |     |
|---|---|---|---|---|---------------------------------------|---|---|-----|
| EQFP (E) <sup>1</sup>                   | FBGA (F)                                |   |   |   |                                       | MBGA (M)                                | UBGA (U)                                |     |
| 144 pin<br>22 x 22 (mm)<br>0.5-mm pitch | 256 pin<br>17 x 17 (mm)<br>1.0-mm pitch | 324 pin<br>19 x 19 (mm)<br>1.0-mm pitch | 484 pin<br>23 x 23 (mm)<br>1.0-mm pitch | 780 pin<br>29 x 29 (mm)<br>1.0-mm pitch | 164 pin<br>8 x 8 (mm)<br>0.5-mm pitch | 256 pin<br>14 x 14 (mm)<br>0.8-mm pitch | 484 pin<br>19 x 19 (mm)<br>0.8-mm pitch |     |
| EP4CE6                                  | 91                                      | 179                                     |   |   |                                       |   | 179                                     |     |
| EP4CE10                                 | 91                                      | 179                                     |   |   |                                       |   | 179                                     |     |
| EP4CE15                                 | 81                                      | 165                                     |   | 343                                     |                                       | 74                                      | 165                                     |     |
| EP4CE22                                 | 79                                      | 153                                     |   |   |                                       |   | 153                                     |     |
| EP4CE30                                 |   |   | 193                                     | 328                                     | 532                                   |   |   |     |
| EP4CE40                                 |   |   | 193                                     | 328                                     | 532                                   |   |   | 328 |
| EP4CE55                                 |   |   |   | 324                                     | 374                                   |   |   | 324 |
| EP4CE75                                 |   |   |   | 292                                     | 426                                   |   |   | 292 |
| EP4CE115                                |   |   |   | 280                                     | 528                                   |   |   |     |

<sup>1</sup> Enhanced thin quad flat pack.

636 Number indicates available user I/O pins.

Vertical migration (same V<sub>CC</sub>, GND, ISP, and input pins). For vertical migration, the number of user I/Os may be less than the number stated in the table.

|                            |                                  | Maximum Resource Count for Cyclone III FPGAs (1.2 V)  |        |        |        |        |        |        |         |
|----------------------------|----------------------------------|---|--------|--------|--------|--------|--------|--------|---------|
|                            |                                  | EP3C5   | EP3C10 | EP3C16 | EP3C25 | EP3C40 | EP3C55 | EP3C80 | EP3C120 |
| Resources                  | LEs (K)                          | 5   | 10     | 15     | 25     | 40     | 56     | 81     | 119     |
|                            | M9K memory blocks                | 46  | 46     | 56     | 66     | 126    | 260    | 305    | 432     |
|                            | Embedded memory (Kb)             | 414   | 414    | 504    | 594    | 1,134  | 2,340  | 2,745  | 3,888   |
|                            | 18 x 18 multipliers              | 23  | 23     | 56     | 66     | 126    | 156    | 244    | 288     |
| Architectural Features     | Global clock networks            | 10  | 10     | 20     | 20     | 20     | 20     | 20     | 20      |
|                            | PLLs                             | 2   | 2      | 4      | 4      | 4      | 4      | 4      | 4       |
|                            | Design security                  | -   |        |        |        |        |        |        |         |
| I/O Features               | I/O voltage levels supported (V) | 1.2, 1.5, 1.8, 2.5, 3.3   |        |        |        |        |        |        |         |
|                            | I/O standards supported          | LVDS, LVPECL, Differential SSTL-18, Differential SSTL-2, Differential HSTL, SSTL-18 (I and II), SSTL-2 (I and II), 1.5 V HSTL (I and II), 1.8 V HSTL (I and II), PCI, PCI-X 1.0, LVTTTL, LVCMOS |        |        |        |        |        |        |         |
|                            | Emulated LVDS channels, 840 Mbps | 66  | 66     | 136    | 79     | 223    | 159    | 177    | 229     |
|                            | OCT                              | Series and differential   |        |        |        |        |        |        |         |
| External Memory Interfaces | Memory device supported          | DDR2, DDR, SDR  |        |        |        |        |        |        |         |

|                            |                                  | Maximum Resource Count for Cyclone III LS FPGAs (1.2 V)   |           |           |           |
|----------------------------|----------------------------------|---|-----------|-----------|-----------|
|                            |                                  | EP3CLS70  | EP3CLS100 | EP3CLS150 | EP3CLS200 |
| Resources                  | LEs (K)                          | 70  | 100       | 151       | 198       |
|                            | M9K memory blocks                | 333   | 483       | 666       | 891       |
|                            | Embedded memory (Kb)             | 2,997   | 4,347     | 5,994     | 8,019     |
|                            | 18 x 18 multipliers              | 200   | 276       | 320       | 396       |
| Architectural Features     | Global clock networks            | 20  |           |           |           |
|                            | PLLs                             | 4   |           |           |           |
|                            | Design security                  | ✓   |           |           |           |
| I/O Features               | I/O voltage levels supported (V) | 1.2, 1.5, 1.8, 2.5, 3.3   |           |           |           |
|                            | I/O standards supported          | LVDS, LVPECL, Differential SSTL-18, Differential SSTL-2, Differential HSTL, SSTL-18 (I and II), SSTL-2 (I and II), 1.5 V HSTL (I and II), 1.8 V HSTL (I and II), PCI, PCI-X 1.0, LVTTTL, LVCMOS |           |           |           |
|                            | LVDS channels, 840 Mbps          | 169   |           |           |           |
|                            | OCT                              | Series and differential   |           |           |           |
| External Memory Interfaces | Memory device supported          | DDR2, DDR, SDR  |           |           |           |



| Cyclone III FPGAs (1.2 V) |   |                                       |   |   |   |   |   |   |   |
|---------------------------|---|---------------------------------------|---|---|---|---|---|---|---|
|                           | EQFP (E)                                | MBGA (M) <sup>1</sup>                 | PQFP (Q) <sup>2</sup>                       | FBGA (F)                                |   |   |   | UBGA (U)                                |   |
|                           | 144 pin<br>22 x 22 (mm)<br>0.5-mm pitch | 164 pin<br>8 x 8 (mm)<br>0.5-mm pitch | 240 pin<br>34.6 x 34.6 (mm)<br>0.5-mm pitch | 256 pin<br>17 x 17 (mm)<br>1.0-mm pitch | 324 pin<br>19 x 19 (mm)<br>1.0-mm pitch | 484 pin<br>23 x 23 (mm)<br>1.0-mm pitch | 780 pin<br>29 x 29 (mm)<br>1.0-mm pitch | 256 pin<br>14 x 14 (mm)<br>0.8-mm pitch | 484 pin<br>19 x 19 (mm)<br>0.8-mm pitch |
| EP3C5                     | 94                                      | 106                                   |   | 182                                     |   |   |   | 182                                     |   |
| EP3C10                    | 94                                      | 106                                   |   | 182                                     |   |   |   | 182                                     |   |
| EP3C16                    | 84                                      | 92                                    | 160   | 168                                     |   | 346                                     |   | 168                                     | 346                                     |
| EP3C25                    | 82                                      |                                       | 148   | 156                                     | 215                                     |   |   | 156                                     |   |
| EP3C40                    |   |                                       | 128   |   | 196                                     | 331                                     | 535                                     |   | 331                                     |
| EP3C55                    |   |                                       |   |   |   | 327                                     | 377                                     |   | 327                                     |
| EP3C80                    |   |                                       |   |   |   | 295                                     | 429                                     |   | 295                                     |
| EP3C120                   |   |                                       |   |   |   | 283                                     | 531                                     |   |   |
| EP3CLS70                  |   |                                       |   |   |   | 294                                     | 429                                     |   | 294                                     |
| EP3CLS100                 |   |                                       |   |   |   | 294                                     | 429                                     |   | 294                                     |
| EP3CLS150                 |   |                                       |   |   |   | 226                                     | 429                                     |   |   |
| EP3CLS200                 |   |                                       |   |   |   | 226                                     | 429                                     |   |   |

<sup>1</sup> Micro FineLine BGA.

<sup>2</sup> Plastic quad flat pack.

 Number indicates available user I/O pins.

 Vertical migration (same V<sub>CC</sub>, GND, ISP, and input pins). For vertical migration, the number of user I/Os may be less than the number stated in the table.

|                        |  | MAX V CPLDs (1.8 V)     |       |        |        |        |   |                |
|------------------------|--|-------------------------|-------|--------|--------|--------|---|----------------|
|                        |  | 5M40Z                   | 5M80Z | 5M160Z | 5M240Z | 5M570Z | 5M1270Z                                   | 5M2210Z        |
| Density and Speed      | LEs                                      | 40                      | 80    | 160    | 240    | 570    | 1270                                      | 2210           |
|                        | Equivalent macrocells <sup>1</sup>       | 32                      | 64    | 128    | 192    | 440    | 980                                       | 1700           |
|                        | Pin-to-pin delay (ns)                    | 7.5                     | 7.5   | 7.5    | 7.5    | 9.0    | 6.2                                       | 7.0            |
|                        | User flash memory (Kb)                   | 8                       |       |        |        |        |   |                |
|                        | Total on-chip memory (bits) <sup>2</sup> | Yes                     | Yes   | Yes    | Yes    | Yes    | Yes                                       | Yes            |
| Architectural Features | Internal oscillator                      | ✓                       |       |        |        |        |   |                |
|                        | Digital PLL <sup>3</sup>                 | ✓                       |       |        |        |        |   |                |
|                        | Fast power on reset                      | ✓                       |       |        |        |        |   |                |
|                        | Boundary scan JTAG                       | ✓                       |       |        |        |        |   |                |
|                        | JTAG ISP                                 | ✓                       |       |        |        |        |   |                |
|                        | Fast input registers                     | ✓                       |       |        |        |        |   |                |
|                        | Programmable register power up           | ✓                       |       |        |        |        |   |                |
|                        | JTAG translator                          | ✓                       |       |        |        |        |   |                |
|                        | Real-time ISP                            | ✓                       |       |        |        |        |   |                |
| I/O Features           | Multivolt I/Os (V)                       | 1.2, 1.5, 1.8, 2.5, 3.3 |       |        |        |        | 1.2, 1.5, 1.8, 2.5, 3.3, 5.0 <sup>4</sup> |                |
|                        | I/O power banks                          | 2                       | 2     | 2      | 2      | 2      | 4   | 4              |
|                        | Maximum output enables                   | 54                      | 54    | 79     | 114    | 159    | 271                                       | 271            |
|                        | LVTTTL/LVCMOS                            | ✓                       |       |        |        |        |   |                |
|                        | LVDS outputs                             | Yes                     | Yes   | Yes    | Yes    | Yes    | Yes                                       | Yes            |
|                        | 32 bit, 66 MHz PCI compliant             | -                       | -     | -      | -      | -      | ✓ <sup>4</sup>                            | ✓ <sup>4</sup> |
|                        | Schmitt triggers                         | ✓                       |       |        |        |        |   |                |
|                        | Programmable slew rate                   | ✓                       |       |        |        |        |   |                |
|                        | Programmable pull-up resistors           | ✓                       |       |        |        |        |   |                |
|                        | Programmable ground pins                 | ✓                       |       |        |        |        |   |                |
|                        | Open-drain outputs                       | ✓                       |       |        |        |        |   |                |
|                        | Bus hold                                 | ✓                       |       |        |        |        |   |                |

<sup>1</sup>Typical equivalent macrocells.

<sup>2</sup>Unused LEs can be converted to memory. The total number of available LE RAM bits depends on the memory mode, depth, and width configurations of the instantiated memory.

<sup>3</sup>Optional IP core. Contact your Altera sales representative for availability.

<sup>4</sup>An external resistor must be used for 5 V tolerance.

|                        |                                    | MAX II CPLDs (3.3 V, 2.5 V, 1.8 V) |                    |                                      |                                      |
|------------------------|------------------------------------|------------------------------------|--------------------|--------------------------------------|--------------------------------------|
|                        |                                    | EPM240/Z                           | EPM570/Z           | EPM1270                              | EPM2210                              |
| Density and Speed      | Equivalent macrocells <sup>1</sup> | 192                                | 440                | 980                                  | 1,700                                |
|                        | Pin-to-pin delay (ns)              | 4.7, 7.5                           | 5.4, 9.0           | 6.2                                  | 7.0                                  |
| Architectural Features | User flash memory (Kb)             | 8                                  |                    |                                      |                                      |
|                        | Boundary scan JTAG                 | ✓                                  |                    |                                      |                                      |
|                        | JTAG ISP                           | ✓                                  |                    |                                      |                                      |
|                        | Fast input registers               | ✓                                  |                    |                                      |                                      |
|                        | Programmable register power up     | ✓                                  |                    |                                      |                                      |
|                        | JTAG translator                    | ✓                                  |                    |                                      |                                      |
|                        | Real-time ISP                      | ✓                                  |                    |                                      |                                      |
| I/O Features           | Multivolt I/Os (V)                 | 1.5, 1.8, 2.5, 3.3                 | 1.5, 1.8, 2.5, 3.3 | 1.5, 1.8, 2.5, 3.3, 5.0 <sup>2</sup> | 1.5, 1.8, 2.5, 3.3, 5.0 <sup>2</sup> |
|                        | I/O power banks                    | 2                                  | 2                  | 4                                    | 4                                    |
|                        | Maximum output enables             | 80                                 | 160                | 212                                  | 272                                  |
|                        | LVTTL/LVCMOS                       | ✓                                  |                    |                                      |                                      |
|                        | 32 bit, 66 MHz PCI compliant       | -                                  | -                  | ✓ <sup>2</sup>                       | ✓ <sup>2</sup>                       |
|                        | Schmitt triggers                   | ✓                                  |                    |                                      |                                      |
|                        | Programmable slew rate             | ✓                                  |                    |                                      |                                      |
|                        | Programmable pull-up resistors     | ✓                                  |                    |                                      |                                      |
|                        | Programmable ground pins           | ✓                                  |                    |                                      |                                      |
|                        | Open-drain outputs                 | ✓                                  |                    |                                      |                                      |
|                        | Bus hold                           | ✓                                  |                    |                                      |                                      |

<sup>1</sup>Typical equivalent macrocells.<sup>2</sup>An external resistor must be used for 5 V tolerance.

| MAX V CPLDs (1.8 V) <sup>1</sup>     |   |   |  |                                      |                                       |   |   |
|--------------------------------------|---|---|--|--------------------------------------|---------------------------------------|---|---|
| EQFP (E) <sup>2</sup>                | TQFP (T) <sup>3</sup>                   |   | MBGA (M) <sup>4</sup>                    |                                      |                                       | FBGA (F)                                |   |
| 64 pin<br>7 x 7 (mm)<br>0.4-mm pitch | 100 pin<br>14 x 14 (mm)<br>0.5-mm pitch | 144 pin<br>20 x 20 (mm)<br>0.5-mm pitch | 64 pin<br>4.5 x 4.5 (mm)<br>0.5-mm pitch | 68 pin<br>5 x 5 (mm)<br>0.5-mm pitch | 100 pin<br>6 x 6 (mm)<br>0.5-mm pitch | 256 pin<br>17 x 17 (mm)<br>1.0-mm pitch | 324 pin<br>19 x 19 (mm)<br>1.0-mm pitch |
| 5M40Z                                | 54                                      |   | 30                                       |                                      |                                       |   |   |
| 5M80Z                                | 54                                      | 79                                      | 30                                       | 52                                   |                                       |   |   |
| 5M160Z                               | 54                                      | 79                                      |  | 52                                   | 79                                    |   |   |
| 5M240Z                               |   | 79                                      | 114                                      | 52                                   | 79                                    |   |   |
| 5M570Z                               |   | 74                                      | 114                                      |                                      | 74                                    | 159                                     |   |
| 5M1270Z                              |   |   | 114                                      |                                      |                                       | 211                                     | 271                                     |
| 5M2210Z                              |   |   |  |                                      |                                       | 203                                     | 271                                     |

| MAX II CPLDs (3.3 V, 2.5 V, 1.8 V) <sup>1</sup> |   |   |   |   |                                      |                                       |                                       |   |
|---|---|---|---|---|--------------------------------------|---------------------------------------|---------------------------------------|---|
| TQFP (T)  |   | FBGA (F)                                |   |   | MBGA (M)                             |                                       |                                       |   |
| 100 pin<br>16 x 16 (mm)<br>0.5-mm pitch         | 144 pin<br>22 x 22 (mm)<br>0.5-mm pitch | 100 pin<br>11 x 11 (mm)<br>1.0-mm pitch | 256 pin<br>17 x 17 (mm)<br>1.0-mm pitch | 324 pin<br>19 x 19 (mm)<br>1.0-mm pitch | 68 pin<br>5 x 5 (mm)<br>0.5-mm pitch | 100 pin<br>6 x 6 (mm)<br>0.5-mm pitch | 144 pin<br>7 x 7 (mm)<br>0.5-mm pitch | 256 pin<br>11 x 11 (mm)<br>0.5-mm pitch |
| EPM240Z   |   |   |   |   | 54                                   | 80                                    |                                       |   |
| EPM570Z   |   |   |   |   |                                      | 76                                    | 116                                   | 160                                     |
| EPM240  | 80                                      |   | 80                                      |   |                                      | 80                                    |                                       |   |
| EPM570  | 76                                      | 116                                     | 76                                      | 160                                     |                                      | 76                                    |                                       | 160                                     |
| EPM1270   |   | 116                                     |   | 212                                     |                                      |                                       |                                       | 212                                     |
| EPM2210   |   |   |   | 204                                     | 272                                  |                                       |                                       |   |

<sup>1</sup>For temperature grades of specific packages (commercial, industrial, or extended temperatures), refer to Altera's online selector guide.

<sup>2</sup>Enhanced quad flat pack.

<sup>3</sup>Thin quad flat pack.

<sup>4</sup>Micro FineLine BGA (0.5 mm).

636 Number indicates available user I/O pins.

Vertical migration (same V<sub>CC</sub>, GND, ISP, and input pins). For vertical migration, the number of user I/Os may be less than the number stated in the table.



Powering  
Your Innovation

Altera develops FPGAs and CPLDs using advanced process technologies that provide fast performance and high-logic density. To meet demanding power requirements, Altera’s Enpirion products deliver the industry’s first family of power system-on-chip (PowerSoC) DC-DC converters featuring integrated inductors. They provide an industry-leading combination of high efficiency, small footprint, and low-noise performance.

## Powering Your Innovation

### Key Intellectual Property

- High-frequency power conversion
- Magnetics engineering
- Power packaging and construction

### Integrated Power Management Systems

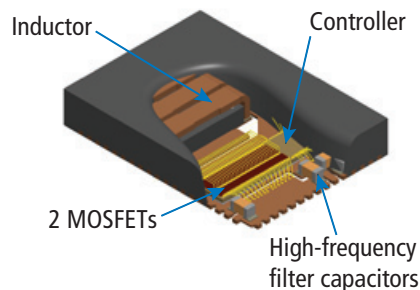

### Engineered Turnkey Solutions

- Fully simulated, characterized, and validated
- System-level qualified
- Eliminates inductor and capacitor selection

## Benefits

Addressing today's and tomorrow's system power design challenges:

### Highest Power Density and Smallest Footprint

Greatly minimizes the amount of PCB space and height profile required for point-of-load regulation compared to alternative discrete switching regulators and modules.

### High Efficiency and Thermal Performance

Optimized with up to 96 percent efficiency. High-efficiency devices are industrial graded, with most devices not requiring load de-rating or air flow at 85°C ambient temperature.

### Lowest Component Count and Higher Reliability

PowerSoCs are specified, simulated, characterized, validated, and manufacturing-tested as a complete power system. Fewer components and tightly controlled IC manufacturing processes permit an unsurpassed 280,000-year mean time between failures (MTBF) reliability.

### Ease of Design and Fastest Time to Market

PowerSoCs with integrated inductor and compensation enable turnkey designs. Development requires fewer design steps with significantly less exposure to design iteration versus discrete switching regulators.

### Fully Validated Power Solutions

Fully validated PCB layout and design files enable customers nearly 100 percent first-pass success.

## PowerSoC Comparison



PowerSoC – 25% to 75% smaller footprint than alternative solutions:

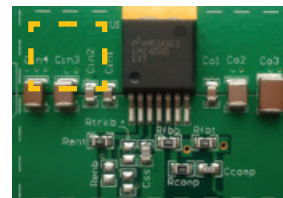

Competitors' Modules

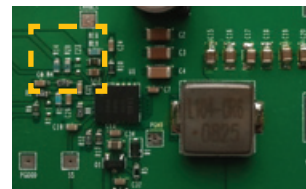

Competitors' Discrete Regulators

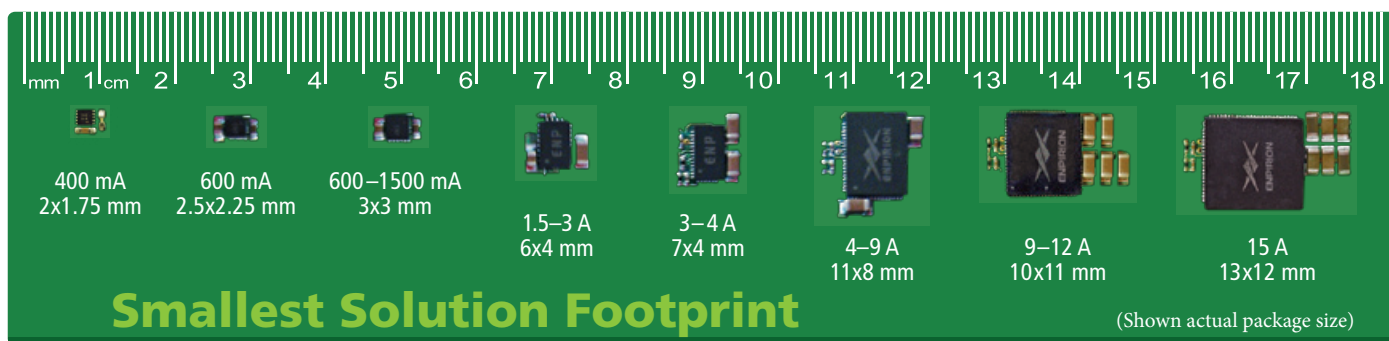
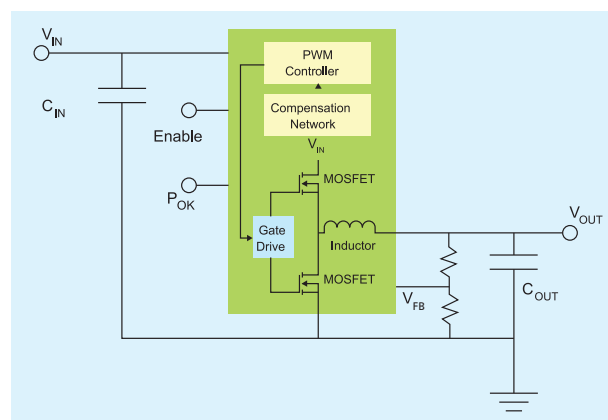

Low Radiated Noise

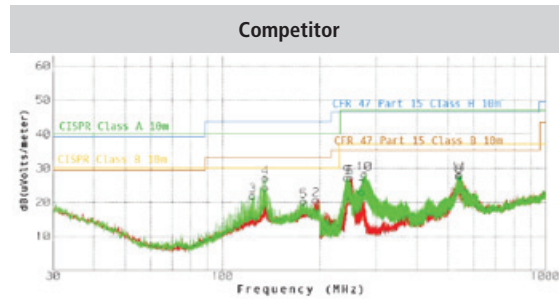
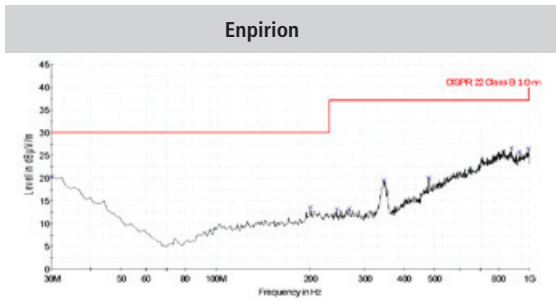

Low Ripple

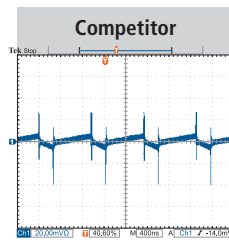
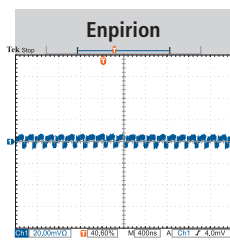

Fast Dynamic Response

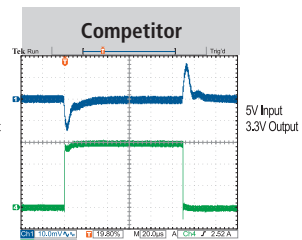
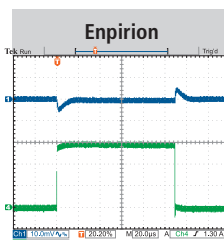

Applications

Market pressures are driving equipment manufacturers to add more features, functionality, and higher bandwidth while moving to smaller form factors and targeting improved energy efficiency. The newest 28 nm and 20 nm FPGAs, processors, and other SoCs address these challenges, in part, by implementing more granular and precise levels of power management. The result is an escalating number of power rails, complex power-up sequencing requirements, and tighter noise tolerances. Enpirion power solutions from Altera meet these power design challenges and are broadly used in many applications.

Computer

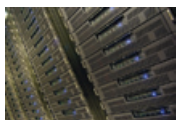

- Server motherboards
- NIC and HBA cards
- RAID controllers
- Micro servers

Enterprise Storage



- Solid State Drives (SSD):
- SATA, SAS, mSATA, PCIe
- Storage systems

Networking and Telecommunications



- Radio basestation (macro, pico, femto)
- Backhaul (microwave, wireline)
- Media gateway (ATCA/AMC)

Test and Measurement



- Network analyzers
- Automated test equipment (ATE)
- Data acquisition
- Scopes, analyzers, signal generators

Industrial and Embedded



- Security systems/digital video recorder (DVR)
- Industrial computing
- Industrial communication modules

Optical Networking



- Optical Modules:
- SFP, XFP, CXP, CFP
- Active optical cable
- Reprogrammable add/drop mux

## Featured Products

| Part Number   | I <sub>OUT</sub><br>(A) | V <sub>IN</sub><br>(VDC) | V <sub>o</sub> Range<br>(VDC) <sup>1</sup> | Pkg<br>(pins) | Pkg Size (mm) |      |      | Solution<br>Size<br>(mm <sup>2</sup> ) | Ext. Components | XFB V Adjust | VID V Adjust | Power Good | Program Soft Start | Margining | Input Sync | Output Sync | Parallel Capability | Light Load Mode |
|---|-------------------------|--------------------------|--|---------------|---------------|------|------|--|-----------------|--------------|--------------|------------|--------------------|-----------|------------|-------------|---------------------|-----------------|
|   |                         |                          |  |               | L             | W    | H    |  |                 |              |              |            |                    |           |            |             |                     |                 |
| <b>5300 5 V Step-Down Converters</b>                        |                         |                          |  |               |               |      |      |  |                 |              |              |            |                    |           |            |             |                     |                 |
| EP5348UI  | 0.4                     | 2.400 – 5.5              | 0.60 – 3.7                                 | uQFN14        | 2.0           | 1.75 | 0.9  | 21                                     | 5               | •            |              |            |                    |           |            |             |                     |                 |
| EP535[x]HUI <sup>2</sup>                                    | 0.6                     | 2.400 – 5.5              | 1.80 – 3.3                                 | uQFN16        | 2.5           | 2.25 | 1.1  | 14                                     | 2               |              | 3-pin        |            |                    |           |            |             |                     | •               |
| EP535[x]LUI <sup>2</sup>                                    | 0.6                     | 2.400 – 5.5              | 0.60 – 1.5 (3.7)                           | uQFN16        | 2.5           | 2.25 | 1.1  | 14                                     | 3               | •            | 3-pin        |            |                    |           |            |             |                     | •               |
| EP53A[x]HQI <sup>2</sup>                                    | 1.0                     | 2.400 – 5.5              | 1.80 – 3.3                                 | QFN16         | 3.0           | 3.0  | 1.1  | 21                                     | 2               |              | 3-pin        |            |                    |           |            |             |                     | •               |
| EP53A[x]LQI <sup>2</sup>                                    | 1.0                     | 2.400 – 5.5              | 0.60 – 1.5 (3.7)                           | QFN16         | 3.0           | 3.0  | 1.1  | 21                                     | 3               | •            | 3-pin        |            |                    |           |            |             |                     | •               |
| EP53F8QI  | 1.5                     | 2.400 – 5.5              | 0.60 – 3.7                                 | QFN16         | 3.0           | 3.0  | 1.1  | 40                                     | 5               | •            |              | •          |                    |           |            |             |                     |                 |
| EN5319QI  | 1.5                     | 2.375 – 5.5              | 0.60 – 3.7                                 | QFN24         | 4.0           | 6.0  | 1.1  | 55                                     | 6               | •            |              | •          |                    |           |            |             |                     |                 |
| EN5329QI  | 2.0                     | 2.375 – 5.5              | 0.60 – 3.7                                 | QFN24         | 4.0           | 6.0  | 1.1  | 55                                     | 6               | •            |              | •          |                    |           |            |             |                     |                 |
| EN5339QI  | 3.0                     | 2.375 – 5.5              | 0.60 – 3.7                                 | QFN24         | 4.0           | 6.0  | 1.1  | 55                                     | 7               | •            |              | •          |                    |           |            |             |                     |                 |
| EN5364QI  | 6.0                     | 2.375 – 6.6              | 0.60 – 3.3                                 | QFN68         | 8.0           | 11.0 | 1.85 | 160                                    | 5               | •            |              | •          | •                  | •         | •          | •           | •                   | •               |
| EN5367QI  | 6.0                     | 2.375 – 5.5              | 0.60 – 3.3                                 | QFN54         | 10.0          | 5.5  | 3.0  | 160                                    | 9               | •            |              | •          | •                  |           | •          |             |                     |                 |
| EN5394QI  | 9.0                     | 2.375 – 6.6              | 0.60 – 3.3                                 | QFN68         | 8.0           | 11.0 | 1.85 | 190                                    | 5               | •            |              | •          | •                  | •         | •          | •           | •                   | •               |
| <b>6300 Efficiency-Optimized Step-Down DC-DC Converters</b> |                         |                          |  |               |               |      |      |  |                 |              |              |            |                    |           |            |             |                     |                 |
| EN6310QI  | 1.0                     | 2.400 – 6.0              | 0.60 – 3.3                                 | QFN28         | 4.0           | 5.0  | 1.85 | 40                                     | 6               | •            |              | •          | •                  |           |            |             |                     |                 |
| EN6337QI  | 3.0                     | 2.375 – 6.6              | 0.60 – 3.3                                 | QFN38         | 4.0           | 7.0  | 1.85 | 75                                     | 6               | •            |              | •          | •                  |           | •          |             |                     | •               |
| EN6347QI  | 4.0                     | 2.375 – 6.6              | 0.60 – 3.3                                 | QFN38         | 4.0           | 7.0  | 1.85 | 75                                     | 6               | •            |              | •          | •                  |           | •          |             |                     | •               |
| EN6360QI  | 8.0                     | 2.375 – 6.6              | 0.60 – 3.3                                 | QFN68         | 8.0           | 11.0 | 3.0  | 190                                    | 10              | •            |              | •          | •                  | •         | •          | •           | •                   | •               |
| EN63A0QI  | 12.0                    | 2.375 – 6.6              | 0.60 – 3.3                                 | QFN76         | 10.0          | 11.0 | 3.0  | 227                                    | 11              | •            |              | •          | •                  | •         | •          | •           | •                   | •               |
| <b>2300 12 V Step-Down Converters</b>                       |                         |                          |  |               |               |      |      |  |                 |              |              |            |                    |           |            |             |                     |                 |
| EN2340QI  | 4.0                     | 4.500 – 14.0             | 0.75 – 5.0                                 | QFN68         | 8.0           | 11.0 | 3.0  | 191                                    | 7               | •            |              | •          | •                  |           | •          | •           |                     |                 |
| EN2360QI  | 6.0                     | 4.500 – 14.0             | 0.75 – 5.0                                 | QFN68         | 8.0           | 11.0 | 3.0  | 200                                    | 9               | •            |              | •          | •                  |           | •          | •           |                     |                 |
| EN2390QI  | 9.0                     | 4.500 – 14.0             | 0.75 – 3.3                                 | QFN76         | 10.0          | 11.0 | 3.0  | 235                                    | 9               | •            |              | •          | •                  |           | •          | •           |                     |                 |
| EN23F0QI  | 15.0                    | 4.500 – 14.0             | 0.75 – 3.3                                 | QFN92         | 13.0          | 12.0 | 3.0  | 325                                    | 13              | •            |              | •          | •                  |           | •          | •           |                     |                 |
| <b>EV1300 Source/Sink DDR VTT Converters</b>                |                         |                          |  |               |               |      |      |  |                 |              |              |            |                    |           |            |             |                     |                 |
| EV1320QI  | 2.0                     | 1.200 – 1.8              | 0.60 – 0.9                                 | QFN16         | 3.0           | 3.0  | 0.55 | 40                                     | 6               |              |              | •          | •                  |           |            |             |                     | •               |
| EV1340QI  | 5.0                     | 1.000 – 1.8              | 0.50 – 0.9                                 | QFN54         | 5.5           | 10.0 | 3.0  | 125                                    | 14              | •            |              | •          | •                  |           |            |             |                     | •               |
| EV1380QI  | 8.0                     | 1.000 – 1.8              | 0.50 – 0.9                                 | QFN68         | 8.0           | 11.0 | 3.0  | 200                                    | 14              | •            |              | •          | •                  |           |            |             |                     | •               |

Notes

- For extended output voltage ranges, see datasheet
- [x] = "8" for PWM only; "7" for Light Load mode

Definitions

- Qualified to industrial (I) ambient temperature range: -40°C to + 85°C
- VID = Output voltage programming using Voltage ID code pins
- Margining = The ability to force V<sub>out</sub> out of regulation by a selectable percentage (via 2 pins)
- Input/Output Sync = ability to control frequency of the regulator(s) to reduce input/output voltage ripple
- Size estimate for single-sided PCB including all suggested external components



The following is an overview of our configuration devices. To determine the right configuration device for your FPGA, check out our Configuration Handbook or the configuration chapter in the handbook of your selected FPGA.

Altera's serial configuration devices store the configuration file for our SRAM-based FPGAs. We designed our serial configuration devices to minimize cost and board space while providing a dedicated FPGA configuration solution. Serial configuration devices are recommended for new designs. For information on additional configuration devices supporting older products, see our Configuration Handbook.

| Serial Configuration Device | Memory Size (bits) | Package |
|-----------------------------|--------------------|---------|
| EPCQ16                      | 16,777,216         | SOIC8   |
| EPCQ32                      | 33,554,432         | SOIC8   |
| EPCQ64                      | 67,108,864         | SOIC16  |
| EPCQ128                     | 134,217,728        | SOIC16  |
| EPCQ256                     | 268,435,456        | SOIC16  |
| EPCQ512                     | 536,870,912        | SOIC16  |

Ordering Information for Stratix V (GT, GX, GS, and E) Devices

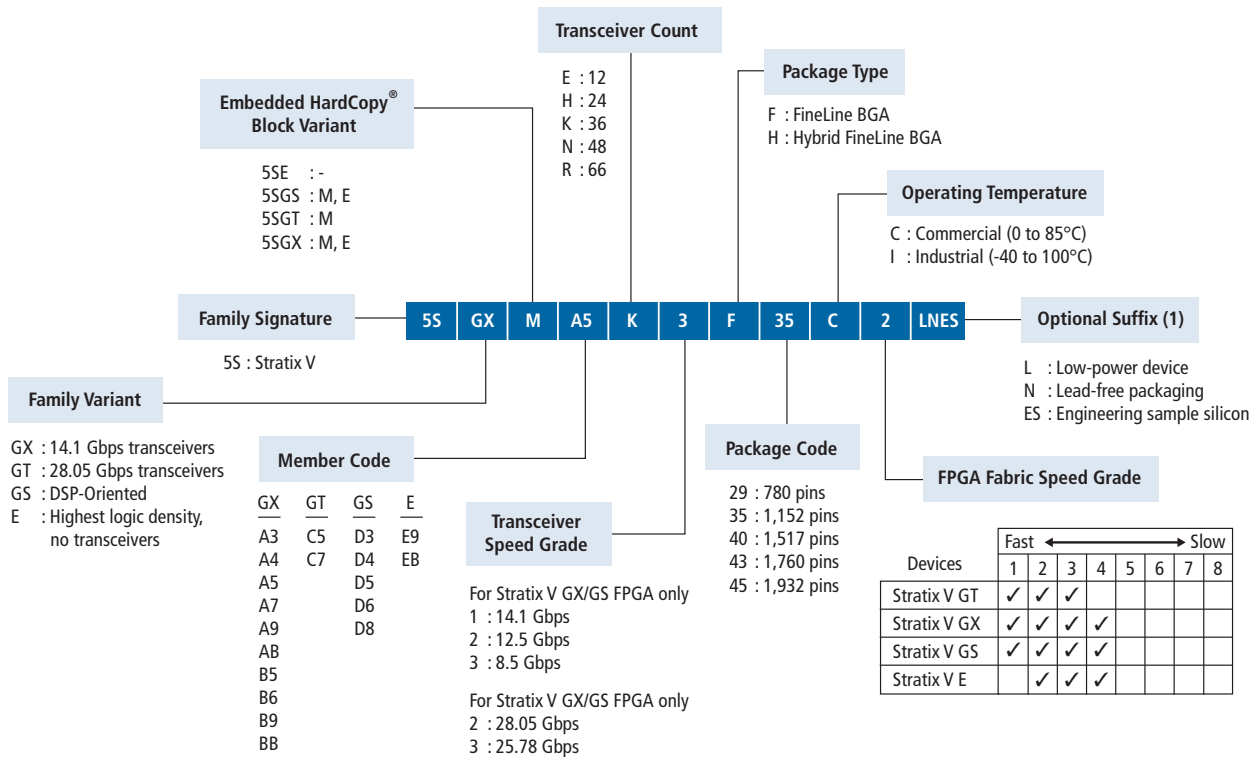

Ordering Information for Stratix IV (E, GX, GT), Cyclone IV (E, GX), Cyclone III, MAX V, and MAX II

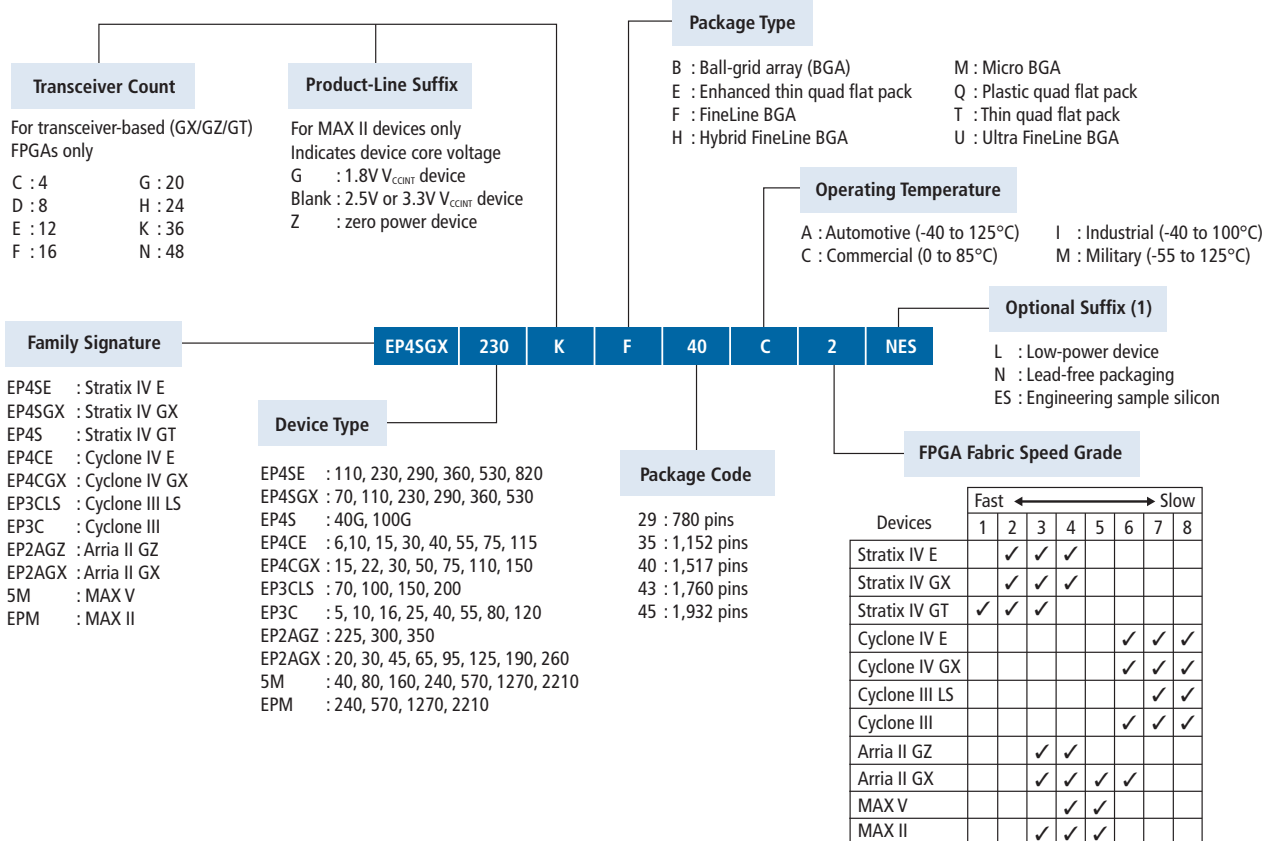

### Ordering Information for Arria 10 (GX and GT) Devices

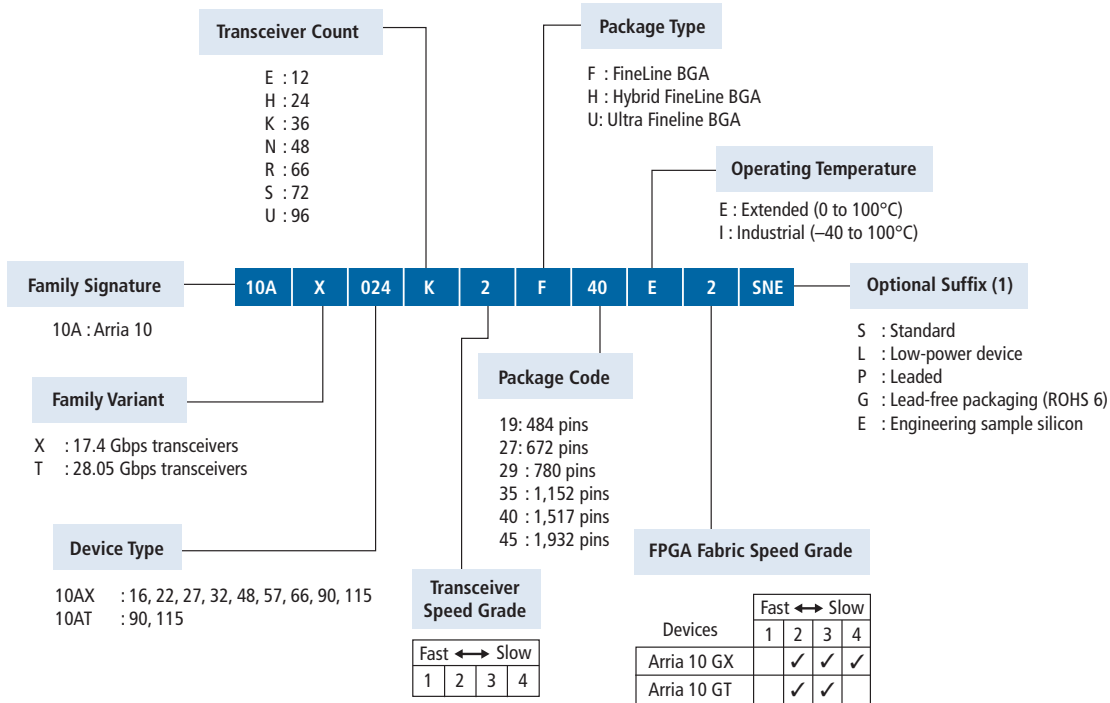

### Ordering Information for Arria 10 (SX) SoCs

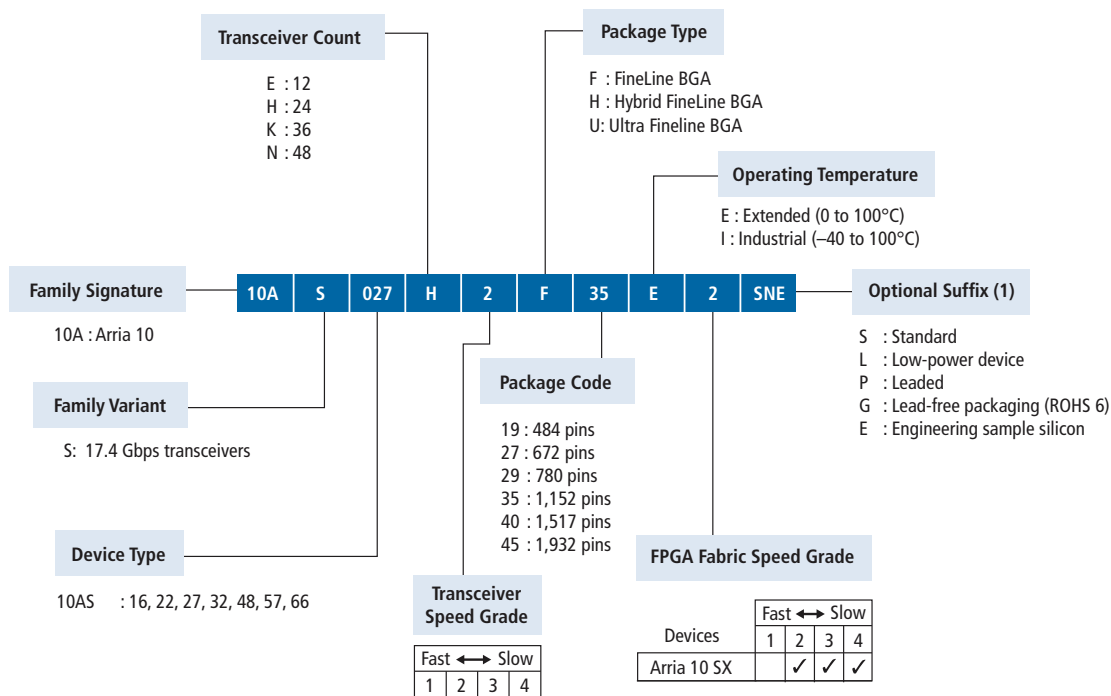

Ordering Information for Arria V (GT, GX, GZ) Devices

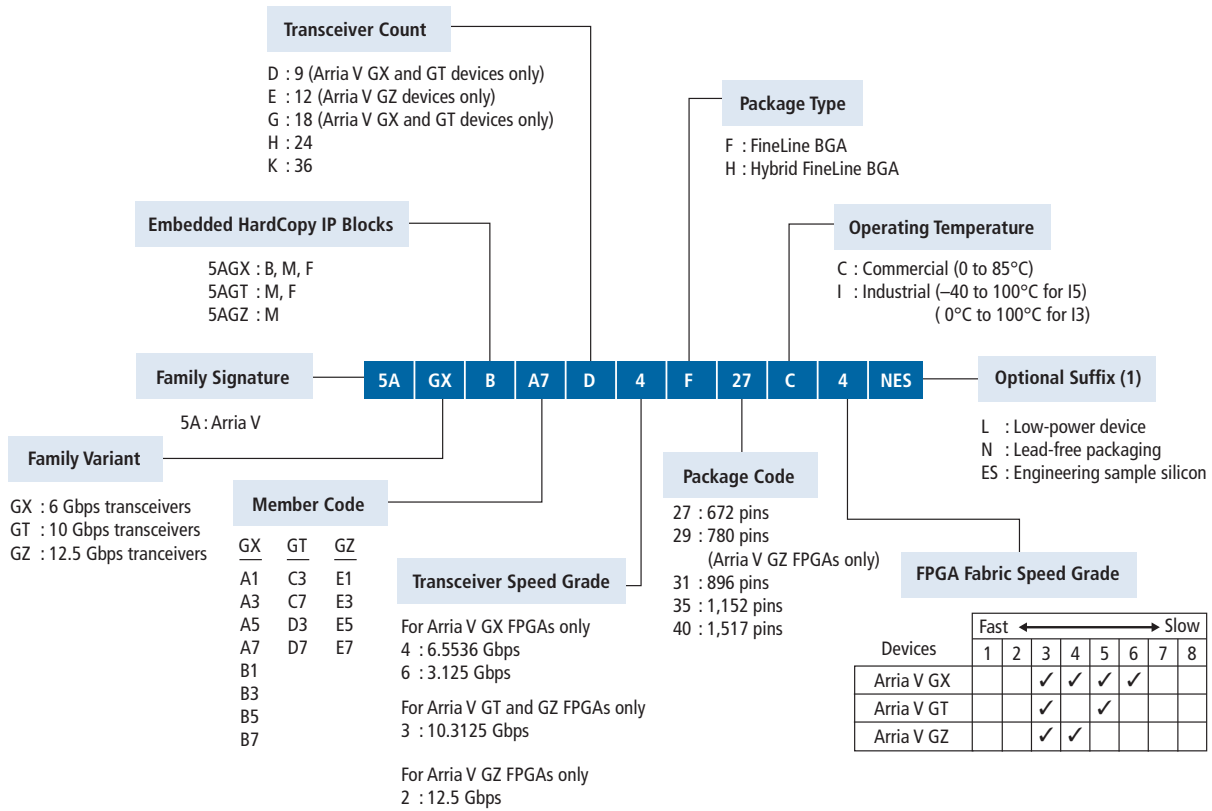

Ordering Information for Arria V (SX, ST) SoCs

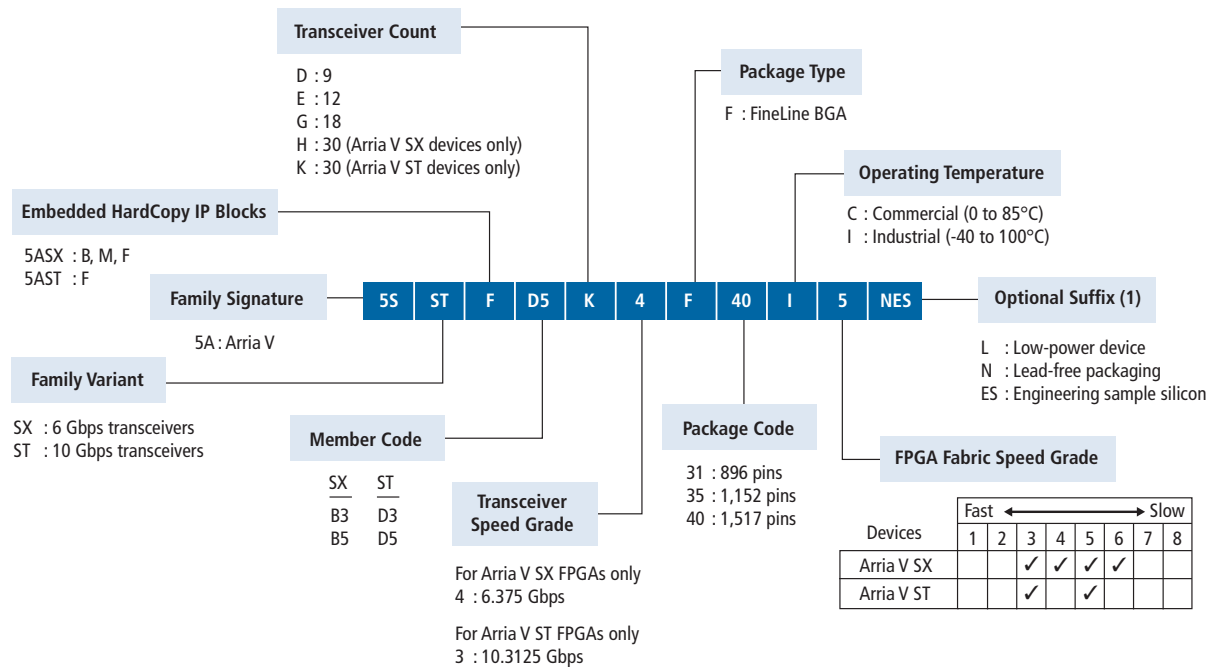

### Ordering Information for Cyclone V (E, GX, GT) Devices

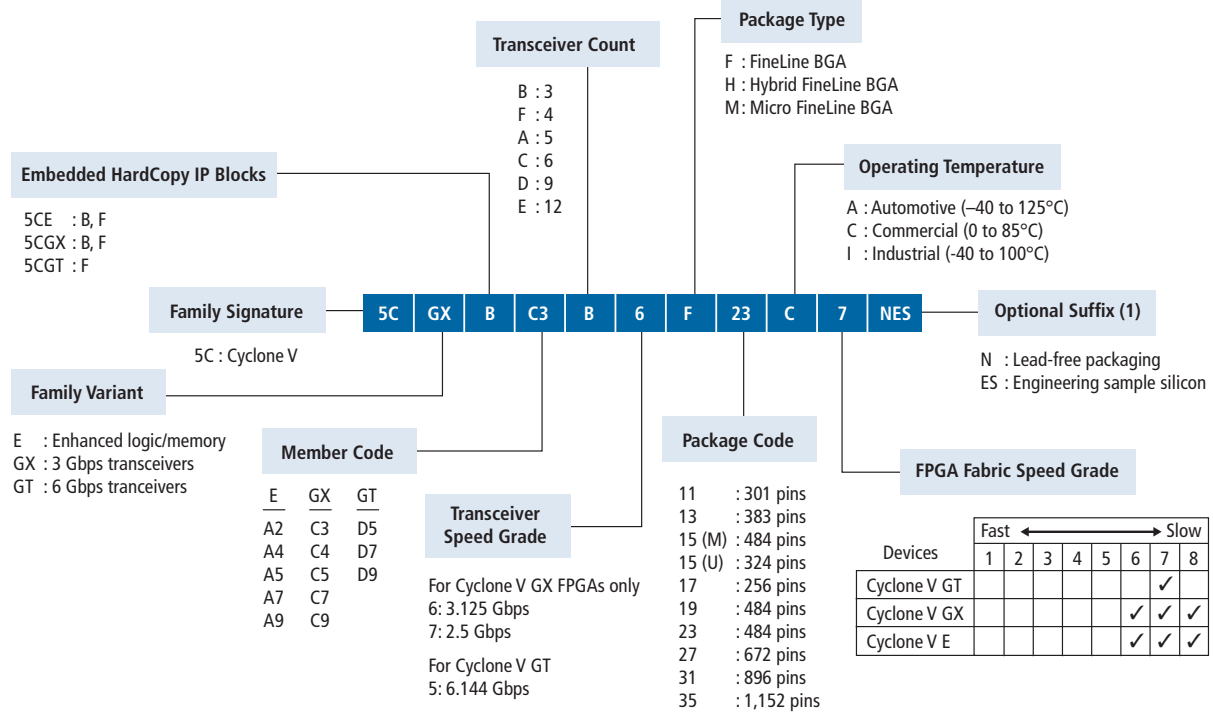

### Ordering Information for Cyclone V (SE, SX, ST) SoCs

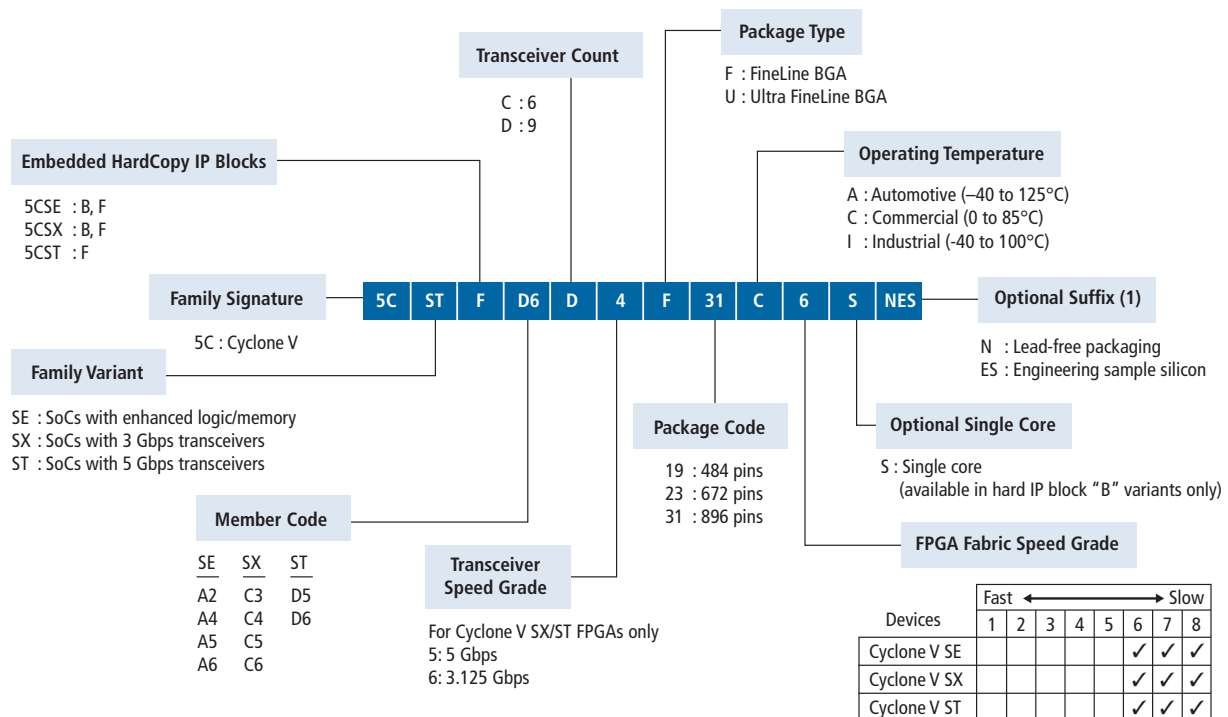

Quartus II software is number one in performance and productivity for CPLD, FPGA, and SoC designs, providing the fastest path to convert your concept into reality. Quartus II software also supports many third-party tools in synthesis, static timing analysis, board-level simulation, signal integrity analysis, and formal verification.

| Quartus II Software Design Flow      |  |                      |                        |
|--------------------------------------|--|----------------------|------------------------|
| Quartus II Software Key Features     |  | Availability         |                        |
|                                      |  | Subscription Edition | Web Edition (Free)     |
| <b>Design Entry</b>                  | Cyclone FPGA and MAX CPLD device support                             | ✓                    | ✓                      |
|                                      | Arria and Stratix FPGA device support                                | ✓                    | ✓ <sup>1</sup>         |
|                                      | Cyclone and Arria SoC support  | ✓                    | ✓                      |
|                                      | Multiprocessor support (faster compile time support)                 | ✓                    | ✓ <sup>2</sup>         |
|                                      | IP base suite (includes licenses for 15 popular IP cores)            | ✓                    | Available for purchase |
|                                      | Qsys (next-generation system–integration tool)                       | ✓                    | ✓                      |
|                                      | Rapid Recompile (faster compile for small design changes)            | ✓                    |                        |
|                                      | Incremental compile (performance preservation and team-based design) | ✓                    |                        |
| <b>Functional Simulation</b>         | ModelSim®-Altera Starter Edition software                            | ✓                    | ✓                      |
|                                      | ModelSim-Altera Edition software                                     | ✓ <sup>3</sup>       | ✓ <sup>3</sup>         |
| <b>Synthesis</b>                     | Quartus Integrated Synthesis (synthesis tool)                        | ✓                    | ✓                      |
| <b>Placement and Routing</b>         | Fitter (placement and routing tool)                                  | ✓                    | ✓                      |
| <b>Timing and Power Verification</b> | TimeQuest tool (static timing analysis)                              | ✓                    | ✓                      |
|                                      | PowerPlay tool and optimization (power analysis)                     | ✓                    | ✓                      |
| <b>In-System Debug</b>               | SignalTap™ II logic analyzer (embedded logic analyzer) <sup>2</sup>  | ✓                    | ✓ <sup>2</sup>         |
|                                      | Transceiver toolkit (transceiver interface and verification tool)    | ✓                    |                        |
| Operating System (OS) Support        |  | Availability         |                        |
|                                      |  | Subscription Edition | Web Edition (Free)     |
| Windows/Linux 32 bit support         |  | ✓                    | ✓                      |
| Windows/Linux 64 bit support         |  | ✓                    | ✓                      |

<sup>1</sup> Only Arria II FPGA - EP2AGX45 device is supported

<sup>2</sup> Available with TalkBack feature enabled.

<sup>3</sup> Requires additional license.

| Quartus II Design Software Features Summary |   |   |
|---|---|---|
| Design Flow Methodology                     | Incremental compilation <sup>1</sup>              | Improves design timing closure and reduces design compilation times up to 70 percent. Supports team-based design.   |
|   | Pin planner                                       | Eases the process of assigning and managing pin assignments for high-density and high-pin-count designs.  |
|   | Qsys (replaces SOPC Builder)                      | Automates system development by integrating IP functions and subsystems (collection of IP functions) using a hierarchical approach and a high-performance interconnect (based on a network-on-a-chip architecture).   |
|   | Off-the-shelf IP cores                            | Lets you construct your system-level design using IP cores from Altera and from Altera's third-party IP partners.   |
|   | Parallel development in ASICs <sup>1</sup>        | Allows for FPGA prototypes to be designed in parallel using the same design software and IP.  |
|   | Scripting support                                 | Supports command-line operation and Tcl scripting, as well as GUI design.   |
|   | Rapid Recompile <sup>1</sup>                      | Maximizes your productivity by reducing your compilation time by 50 percent on average (for a small design change after a full compile). Improves design timing preservation.   |
| Performance and Timing Closure Methodology  | Physical synthesis                                | Uses post placement and routing delay knowledge of a design to improve performance.   |
|   | Design space explorer (DSE)                       | Increases performance by automatically iterating through combinations of Quartus II software settings to find optimal results.  |
|   | Extensive cross-probing                           | Provides support for cross-probing between verification tools and design source files.  |
|   | Optimization advisors                             | Provides design-specific advice to improve performance, resource usage, and power consumption.  |
|   | Chip planner                                      | Reduces verification time (while maintaining timing closure) by enabling small, post placement and routing design changes to be implemented in minutes.   |
| Verification                                | TimeQuest timing analyzer                         | Provides native Synopsys® Design Constraint (SDC) support and allows you to create, manage, and analyze complex timing constraints and quickly perform advanced timing verification.  |
|   | SignalTap II embedded logic analyzer <sup>2</sup> | Supports the most channels, fastest clock speeds, largest sample depths, and most advanced triggering capabilities available in an embedded logic analyzer.   |
|   | System Console                                    | Enables you to easily debug your FPGA in real time using read and write transactions. It also enables you to quickly create a GUI to help monitor and send data into your FPGA.   |
|   | PowerPlay technology                              | Enables you to accurately analyze and optimize both dynamic and static power consumption.   |
| Third-Party Support                         | EDA partners                                      | Offers EDA software support for synthesis, functional and timing simulation, static timing analysis, board-level simulation, signal integrity analysis, and formal verification. To see a complete list of partners, visit <a href="http://www.altera.com/products/software/partners/eda_partners/eda-index.html">www.altera.com/products/software/partners/eda_partners/eda-index.html</a> . |

<sup>1</sup> Included in Subscription Edition only.

<sup>2</sup> Available with Talkback feature enabled in Web Edition.

## Getting Started Steps

### Step 1: Download free Web Edition

[www.altera.com/download](http://www.altera.com/download)

### Step 2: Get oriented with Quartus II software interactive tutorial

After installation, open the interactive tutorial on the welcome screen.

### Step 3: Sign up for training

[www.altera.com/training](http://www.altera.com/training)

Purchase Quartus II software and increase your productivity today.

| Pricing  | Description   |
|--|---|
| <b>\$2,995</b> (SW-QUARTUS-SE-FIX)<br>Renewal \$2,495 (SWR-QUARTUS-SE-FIX)   | Fixed-node license: subscription for one year—Windows only.     |
| <b>\$3,995</b> (SW-QUARTUS-SE-FLT)<br>Renewal \$2,495 (SWR-QUARTUS-SE-FLT)<br>Add seat \$3,995 (SW-QUARTUS-SE-ADD) | Floating-node license: subscription for one year—Windows/Linux. |

| ModelSim-Altera Edition Software                                 |   |
|--|---|
| <b>\$945</b> (SW-MODELSIM-AE)<br>Renewal \$945 (SWR-MODELSIM-AE) | ModelSim-Altera Edition software is available as a \$945 option for both Quartus II Subscription Edition and Web Edition software. It's 33 percent faster than Starter Edition with no line limitation.     |
| ModelSim-Altera Starter Edition Software                         |   |
| <b>Free</b>  | Free for both Quartus II Subscription Edition and Web Edition software with a 10,000 executable line limitation, ModelSim-Altera Starter Edition software is recommended for simulating small FPGA designs. |



The Altera SoC Embedded Design Suite (EDS) is a comprehensive tool suite for embedded software development on Altera SoCs. It comprises development tools, utility programs, run-time software, and design examples to jump-start firmware and application software development. The SoC EDS includes an exclusive offering of the ARM Development Studio™ 5 (DS-5™) Altera Edition Toolkit.

| SoC Embedded Design Suite              |   |                      |                    |
|--|---|----------------------|--------------------|
| SoC EDS Key Features                   |   | Availability         |                    |
|  |   | Subscription Edition | Web Edition (Free) |
| <b>Hardware/Software Handoff Tools</b> | Preloader Generator   | ✓                    | ✓                  |
|  | Device Tree Generator   | ✓                    | ✓                  |
| <b>Compiler Tools</b>                  | Linaro Compiler   | ✓                    | ✓                  |
|  | Sourcery EABI GNU Compiler  | ✓                    | ✓                  |
| <b>Run-time</b>                        | SoC Linux   | ✓                    | ✓                  |
|  | U-Boot  | ✓                    | ✓                  |
| <b>Libraries</b>                       | SoC Abstraction Layer (SoCAL)   | ✓                    | ✓                  |
|  | Hardware Manager  | ✓                    | ✓                  |
| <b>DS-5 Altera Edition Features</b>    | Linux application debugging over Ethernet   | ✓                    | ✓                  |
|  | Debugging over USB-Blaster™ II cable<br>- Board bring-up<br>- Device driver development<br>- Operating system (OS) porting<br>- Bare-metal programming  | ✓                    |                    |
|  | FPGA-adaptive debugging<br>- Auto peripheral register discovery<br>- Cross-triggering between CPU and FPGA domains<br>- ARM CoreSight trace support<br>- Access to System Trace Module (STM) events | ✓                    |                    |
|  | Streamline Performance Analyzer support   | ✓                    | Limited            |
| <b>Getting Started Examples</b>        | Golden system reference designs for SoC development kits  | ✓                    | ✓                  |
| <b>Others</b>                          | Other design examples   | ✓                    | ✓                  |
|  | Quartus II Programmer   | ✓                    | ✓                  |
|  | SignalTap II Logic Analyzer   | ✓                    | ✓                  |
| OS Support                             |   | Availability         |                    |
|  |   | Subscription Edition | Web Edition (Free) |
| Windows/Linux 32 bit support           |   | ✓                    | ✓                  |
| Windows/Linux 64 bit support           |   | Compatible           | Compatible         |

| SoC Embedded Design Suite                 | Pricing |
|---|---------|
| Subscription Edition (ESW-SOCEDS-DS5-FIX) | \$995   |
| Web Edition                               | Free    |

Altera's processor portfolio comprises SoCs, which feature single- or dual-core ARM Cortex-A9 MPCore hard processor systems as well as soft processors that can be used in any FPGA or SoC.

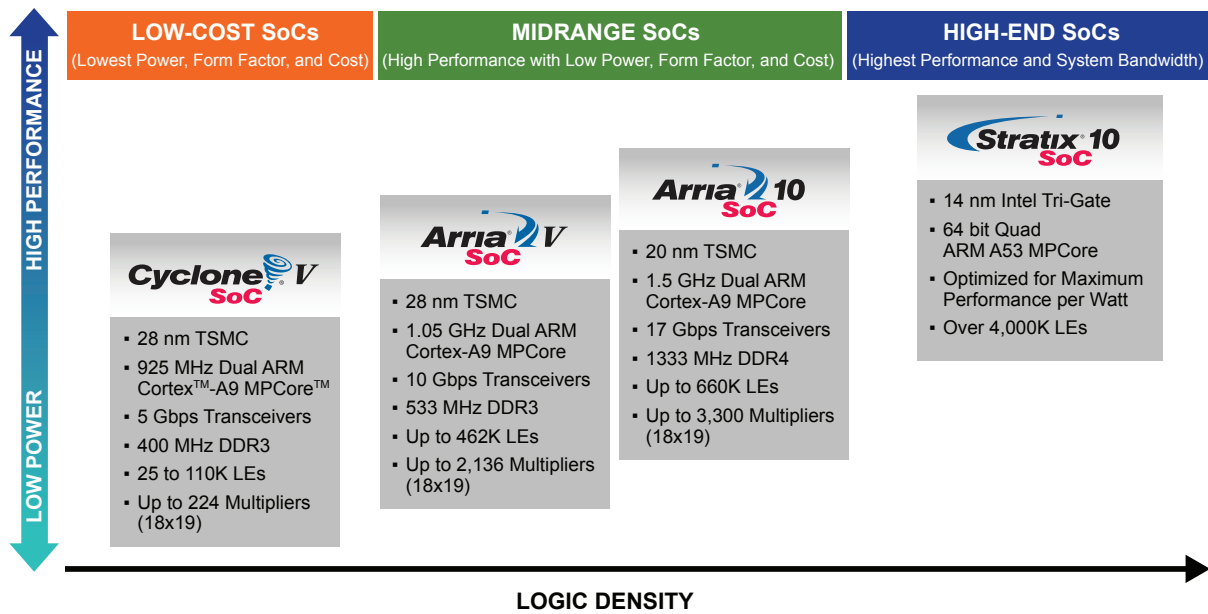

| Summary of Processors                |                                |        |   |
|--------------------------------------|--------------------------------|--------|---|
| Category                             | Processor                      | Vendor | Description   |
| Hard processors for SoC              |                                |        |   |
| Applications processing              | Dual-core ARM Cortex-A9        | Altera | Altera's 28 nm Cyclone V and Arria V SoC families and 20 nm Arria 10 SoCs offer integrated ARM-based HPS, comprising peripherals, memory, and interfaces, with an FPGA fabric.  |
| Soft processors                      |                                |        |   |
| Power- and cost-optimized processing | Nios II economy core           | Altera | With unique, real-time hardware features, such as custom instructions (ability to use FPGA hardware to accelerate a function), vector interrupt controller, and tightly coupled memory, as well as support for industry-leading real-time operating systems (RTOS), the Nios II processor meets both your hard and soft real-time requirements. |
| Real-time processing                 | Nios II standard and fast core | Altera | With unique, real-time hardware features, such as custom instructions (ability to use FPGA hardware to accelerate a function), vector interrupt controller, and tightly coupled memory, as well as support for industry-leading RTOS, the Nios II processor offers a versatile solution for real-time processing.                               |
| Applications processing              | Nios II fast core              | Altera | A simple configuration option enables the Nios II fast core to use a memory management unit to run embedded Linux. Both open source and commercially supported versions of Linux for Nios II processors are available.  |
| Safety-critical processing           | Nios II SC                     | H-Cell | Certify your design for DO-254 compliance by using the Nios II Safety Critical core along with the DO-254 compliance design services offered by H-Cell.   |

| Comparative Summary of Altera's Soft Processors by Performance and Feature Set |                                     |                 |                     |                   |   |  |
|--|-------------------------------------|-----------------|---------------------|-------------------|---|--|
| Category   | Cost-and Power-Sensitive Processors |                 | Real-Time Processor |                   | Applications Processors                           |  |
| Features   | ARM Cortex-M1                       | Nios II Economy | Nios II Standard    | Nios II Fast      | 28 nm <sup>1</sup> Dual-Core ARM Cortex-A9        | 20 nm <sup>2</sup> Dual-Core ARM Cortex-A9 |
| Maximum frequency (MHz)  | 200                                 | 330             | 270                 | 290               | 925 MHz (Cyclone V SoC)<br>1.05 GHz (Arria V SoC) | 1.5 GHz                                    |
| Maximum performance (MIPS <sup>3</sup> at MHz)<br>Stratix series               | 160 at 200                          | 50 at 330       | 170 at 270          | 340 at 290        | –   | –  |
| Maximum performance (MIPS <sup>3</sup> at MHz)<br>Arria series                 | –                                   | 45 at 300       | 115 at 180          | 270 at 240        | 2,625 MIPS per core at 1.05 GHz                   | 3,750 MIPS per core at 1.5 GHz             |
| Maximum performance (MIPS <sup>3</sup> at MHz)<br>Cyclone series               | 80 at 100                           | 30 at 175       | 90 at 145           | 195 at 175        | 2,313 MIPS per core at 925 MHz                    | –  |
| Maximum performance efficiency (MIPS <sup>3</sup> per MHz)                     | 0.8                                 | 0.15            | 0.64                | 1.13              | 2.5   | 2.5  |
| 16/32 bit instruction set support  | 16 and 32                           | 32              | 32                  | 32                | 16 and 32   | 16 and 32                                  |
| Level 1 instruction cache  | –                                   | –               | Configurable        | Configurable      | 32 KB   | 32 KB                                      |
| Level 1 data cache   | –                                   | –               | –                   | Configurable      | 32 KB   | 32 KB                                      |
| Level 2 cache  | –                                   | –               | –                   | –                 | 512 KB  | 512 KB                                     |
| Memory management unit   | –                                   | –               | –                   | ✓                 | ✓   | ✓  |
| Floating-point unit  | –                                   | –               | FPCI <sup>4</sup>   | FPCI <sup>4</sup> | Dual precision                                    | Dual precision                             |
| Vector interrupt controller  | ✓                                   | –               | ✓                   | ✓                 | –   | –  |
| Tightly coupled memory   | Up to 64K                           | –               | Configurable        | Configurable      | –   | –  |
| Custom instruction interface   | –                                   | Up to 256       | Up to 256           | Up to 256         | –   | –  |
| Equivalent LEs   | 2,500                               | 600             | 1,200               | 1,800 – 3,200     | HPS   | HPS  |

<sup>1</sup> Altera 28 nm SoCs comprise Cyclone V SoCs and Arria V SoCs

<sup>2</sup> Altera 20 nm SoCs comprise Arria 10 SoCs

<sup>3</sup> Dhrystone 2.1 benchmark

<sup>4</sup> Floating-point custom instructions

| Available OS Board Support Packages |                      |                   |               |
|-------------------------------------|----------------------|-------------------|---------------|
| OS                                  | OS BSP Supplier      | Nios II Processor | ARM-Based SoC |
| eCos                                | eCosCentric          | ✓                 | ✓             |
| eCos (Zylin)                        | Zylin                | ✓                 | –             |
| embOS                               | Segger               | ✓                 | –             |
| Erika Enterprise                    | Evidence             | ✓                 | –             |
| EUROS                               | Euros                | ✓                 | –             |
| Linux                               | Wind River           | ✓                 | ✓             |
| Linux                               | Timesys              | ✓                 | –             |
| Linux                               | SLS                  | ✓                 | –             |
| Linux                               | Open Source          | ✓                 | ✓             |
| oSCAN                               | Vector               | ✓                 | –             |
| ThreadX                             | Express Logic        | ✓                 | ✓             |
| µCLinux                             | Open Source          | ✓                 | –             |
| VxWorks                             | Wind River           | –                 | ✓             |
| Toppers                             | Open Source          | ✓                 | –             |
| OSE                                 | Enea                 | –                 | ✓             |
| INTEGRITY                           | Green Hills Software | –                 | ✓             |
| µC/OS-II, µC/OS-III                 | Micrium              | ✓                 | ✓             |
| QNX Neutrino                        | QNX                  | –                 | ✓             |
| Android                             | FUJISOFT             | –                 | ✓             |
| Windows Embedded                    | iWave                | –                 | ✓             |
| µITRON                              | eSol                 | –                 | ✓             |

### Getting Started

Learn more about Altera's portfolio of customizable processors and how you can get started by visiting [www.altera.com/embedded](http://www.altera.com/embedded).

Altera's Nios II processor, the world's most versatile processor according to Gartner Research, is the most widely used soft processor in the FPGA industry. This soft processor delivers unprecedented flexibility for your cost-sensitive, real-time, safety-critical (DO-254), and applications processing needs. The Nios II processor supports all Altera FPGA device families.

The Nios II processor in any one of Altera's FPGAs offers a custom SoC solution that has the flexibility of software and the performance of hardware. Through its innovative design, the Nios II processor leverages the logic resources of the device to provide unprecedented hard and soft real-time capabilities.

You can:

- Lower overall system cost, complexity, and power consumption by integrating the processor with the FPGA.
- Scale performance with multiple processors, custom instructions (hardware acceleration of an instruction) or coprocessing (hardware accelerator next to the soft processor).
- Target any Stratix, Arria, or Cyclone series FPGA.
- Eliminate the risk of processor and ASSP obsolescence.
- Take advantage of the free Nios II economy core, the free Nios II Embedded Design Suite (EDS), and the NicheStack TCP/IP Network Stack, Nios II Edition software to get started today.

### Nios II Processor Development Flow

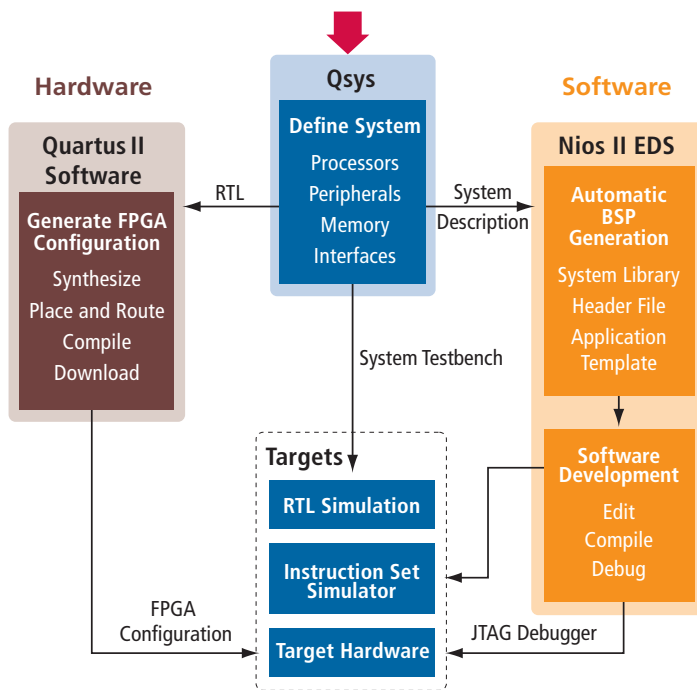

| Nios II EDS Contents   |
|--|
| Code Development Tool: Nios II Software Build Tools for Eclipse <ul style="list-style-type: none"> <li>• New project wizards</li> <li>• Software templates</li> <li>• Source navigator and editor</li> <li>• Compiler for C and C++ (GNU)</li> <li>• Based on industry-standard Eclipse</li> </ul> |
| Source Debugger/Profiler   |
| Flash Programmer   |
| Embedded Software <ul style="list-style-type: none"> <li>• Hardware Abstraction Layer (HAL)</li> <li>• MicroC/OS-II RTOS</li> <li>• NicheStack TCP/IP Network Stack—Nios II Edition</li> <li>• Newlib ANSI-C standard library</li> <li>• Simple file system</li> </ul>                             |
| Other Altera Command-Line Tools and Utilities  |
| Design Examples  |

### Hardware Development Tools

- Quartus II design software
- Qsys system integration tool
- SignalTap II embedded logic analyzer plug-in for Nios II processor
- System Console for low-level debug of Qsys systems

### Licensing

Getting started with the Nios II processor is now easier than ever. Not only is the Nios II EDS free, but the Nios II economy core IP is also free.

As for the Nios II standard and fast core IP, licenses are available for stand-alone IP or as part of the Embedded IP Suite (IPS-EMBED-DED). These royalty-free licenses never expire and allow you to target your processor design on any Altera FPGA. The Embedded IP Suite is a value bundle that contains licenses of the Nios II processor IP core, DDR1/2 Memory Controller IP core, Triple-Speed Ethernet MAC IP core, and the NicheStack TCP/IP Network Stack, Nios II Edition software.

### Development Kits

Go to [page 75](#) for information about embedded development kits.

### Nios II EDS: What You Get for Free!

The Nios II Embedded Design Suite (EDS) provides all the tools and software you need to develop code for the Nios II processor.

With the Nios II EDS you can:

- **Develop software with Nios II Software Build Tools for Eclipse:** Based on industry-standard Eclipse, the Nios II Software Build Tool (SBT) is an integrated development environment for editing, compiling, debugging software code, and flash programming.
- **Manage board support package (BSP):** The Nios II EDS makes managing the BSP easier than ever. Nios II EDS will automatically add device drivers for Altera-provided IP to your BSP. The BSP Editor provides full control over your build options.
- **Get free Network Stack software:** The Nios II EDS includes NicheStack TCP/IP Network Stack, Nios II Edition—a commercial-grade network stack software—for free.
- **Evaluate a RTOS:** The Nios II EDS contains an evaluation version of the popular Micrium MicroS/OS-II RTOS. Product licenses are sold separately by Micrium.

### Join the Nios II Community!

Be part of thousands of Nios II developers by visiting [Altera Wiki](#) and [Altera Forum](#). [Altera Wiki](#) has hundreds of design examples and design tips from Nios II developers all over the world. Join ongoing discussions on the Nios II section of [Altera Forum](#) to know more about Nios II Linux, hardware, and software development.

Visit [www.alterawiki.com](http://www.alterawiki.com) and [www.alteraforum.com](http://www.alteraforum.com).

The following is a partial list of IP functions from Altera and its partners. To get the details, check out our online selector guide.

|     | Product Name                                      | Vendor Name  |
|-----|---|--------------|
| DSP | <b>Error Detection/Correction</b>                 |              |
|     | Reed-Solomon Compiler Decoder                     | Altera       |
|     | Reed-Solomon Compiler Encoder                     | Altera       |
|     | Reed-Solomon Encoder/Decoder II <sup>1</sup>      | Altera       |
|     | Viterbi Compiler, High-Speed Parallel Decoder     | Altera       |
|     | Viterbi Compiler, Low-Speed/Hybrid Serial Decoder | Altera       |
|     | DVB-RCS CTC Turbo Decoder                         | TurboConcept |
|     | WiMAX CTC Decoder                                 | TurboConcept |
|     | 3GPP/LTE CTC Decoder                              | TurboConcept |
|     | Turbo Product Code Decoder                        | TurboConcept |
|     | <b>Filters and Transforms</b>                     |              |
|     | Fast Fourier Transform (FFT)/Inverse FFT (IFFT)   | Altera       |
|     | Cascaded Integrator Comb (CIC) Compiler           | Altera       |
|     | Finite Impulse Response (FIR) Compiler            | Altera       |
|     | FIR Compiler II                                   | Altera       |
|     | 2D Forward/Inverse Discrete Cosine Transform      | CAST, Inc.   |
|     | 2D Inverse Discrete Cosine Transform (IDCT)       | CAST, Inc.   |
|     | Forward Discrete Cosine Transform (DCT)           | CAST, Inc.   |
|     | <b>Modulation/Demodulation</b>                    |              |
|     | Numerically Controlled Oscillator Compiler        | Altera       |
|     | DVB-C/J.83 (QAM) Modulator                        | Commsonic    |
|     | DVB/H T/H Modulator                               | Commsonic    |
|     | DVB-S2 Modulator                                  | Commsonic    |
|     | <b>Video and Image Processing</b>                 |              |
|     | Video and Image Processing Suite <sup>1</sup>     | Altera       |
|     | JPEG Decoder and Encoder                          | Barco Silex  |
|     | JPEG 2000 Sub-Frame Latency Encoder and Decoder   | Barco Silex  |
|     | Multi-Channel JPEG 2000 Encoder and Decoder Cores | Barco Silex  |

|                 | Product Name  | Vendor Name         |
|-----------------|---|---------------------|
| DSP (Continued) | JPEG CODEC  | CAST, Inc.          |
|                 | JPEG Encoders and Decoders  | CAST, Inc.          |
|                 | Lossless JPEG Encoder and Decoder   | CAST, Inc.          |
|                 | H.264 AVC High-Definition (HD) and Extended Definition (ED) Video Encoder | CAST, Inc.          |
|                 | H.264 Encoders  | Jointwave Group LLC |
|                 | <b>Arithmetic</b>   |                     |
|                 | Floating-Point Addition/Subtraction                                       | Altera              |
|                 | Floating-Point Multiplication   | Altera              |
|                 | Floating-Point Division   | Altera              |
|                 | Floating-Point Square Root  | Altera              |
|                 | Floating-Point Compare  | Altera              |
|                 | Floating-Point Arithmetic Unit  | Digital Core Design |
|                 | Floating-Point Mathematics Unit   | Digital Core Design |
|                 | Floating-Point Pipelined Divider Unit                                     | Digital Core Design |
|                 | Floating-Point-to-Integer Pipelined Converter                             | Digital Core Design |
|                 | Integer-to-Floating-Point Pipelined Converter                             | Digital Core Design |
|                 | <b>Additional Functions</b>   |                     |
|                 | Advanced Encryption Standard (AES) Engine                                 | Barco Silex         |
|                 | DES/3DES  | Barco Silex         |
|                 | Hashing   | Barco Silex         |
|                 | Public Key  | Barco Silex         |
|                 | SHA-1   | CAST, Inc.          |
|                 | SHA-256   | CAST, Inc.          |
| AES CODEC       | CAST, Inc.  |                     |

<sup>1</sup>Qsys-compliant licensed core.

|   | Product Name   | Vendor Name          |        |
|---|--|----------------------|--------|
| Embedded Processors   | <b>32 bit/16 bit</b>                                       |                      |        |
|   | Nios II Embedded Processor <sup>1</sup>                    | Altera               |        |
|   | ARM Cortex-A9 MPCore Processor                             | Altera               |        |
|   | ARM Cortex-M1 <sup>1</sup>                                 | ARM                  |        |
|   | C68000 and AHB Microprocessors                             | CAST, Inc.           |        |
|   | C80186EC and XL Microprocessors                            | CAST, Inc.           |        |
|   | V1 ColdFire <sup>1</sup>                                   | Freescale            |        |
|   | <b>8 bit</b>   |                      |        |
|   | T8051  | CAST, Inc.           |        |
|   | 8051XC2 Microcontroller                                    | CAST, Inc.           |        |
|   | DP8051 8 bit Microcontroller                               | Digital Core Design  |        |
|   | DP8051XP Pipelined, High-Performance 8 bit Microcontroller | Digital Core Design  |        |
|   | DF6811E 8 bit Fast Microcontroller                         | Digital Core Design  |        |
|   | DFPIC1655X 8 bit RISC Microcontroller                      | Digital Core Design  |        |
|   | Interface and Protocols                                    | <b>Communication</b> |        |
|   |  | POS-PHY Level 4      | Altera |
| Optical Transport Network (OTN) Framers/Deframers                           |  | Altera               |        |
| SFI-5.1   |  | Altera               |        |
| SONET / Synchronous Digital Hierarchy (SDH) Framer / Deframer               |  | Aliathon             |        |
| SONET / SDH Mapper / Demapper   |  | Aliathon             |        |
| Synchronous Data Link Control (SDLC) Controller                             |  | CAST, Inc.           |        |
| <b>Ethernet</b>   |  |                      |        |
| 10 Gbps Ethernet MAC <sup>1</sup> with 1588                                 |  | Altera               |        |
| Triple-Speed Ethernet (10/100/1000 Mbps) MAC and PHY <sup>1</sup> with 1588 |  | Altera               |        |
| 10GBASE-R PHY   |  | Altera               |        |
| 10G Base-X (XAUI) PHY   |  | Altera               |        |

<sup>1</sup>Qsys-compliant licensed core.

|                                     | Product Name                         | Vendor Name       |
|-------------------------------------|--------------------------------------|-------------------|
| Interface and Protocols (Continued) | 40G Ethernet MAC and PHY             | Altera            |
|                                     | 100G Ethernet MAC and PHY            | Altera            |
|                                     | Backplane Ethernet 10GBASE-KR PHY    | Altera            |
|                                     | 1G/10Gb Ethernet PHY                 | Altera            |
|                                     | Gbps Ethernet (GbE) MAC <sup>1</sup> | IFI               |
|                                     | Advanced GbE MAC <sup>1</sup>        | IFI               |
|                                     | EtherCAT (Software Stack)            | IXXAT             |
|                                     | Ethernet Powerlink                   | IXXAT             |
|                                     | EtherNET/IP                          | IXXAT             |
|                                     | Fast XAUI                            | Macnica Americas  |
|                                     | 10G MAC Lite                         | Macnica Americas  |
|                                     | 40G/100G Ethernet                    | MorethanIP        |
|                                     | 10GbE MAC and PCS                    | MorethanIP        |
|                                     | RXAUI PCS                            | MorethanIP        |
|                                     | SPAUI MAC                            | MorethanIP        |
|                                     | DXAUI PCS                            | MorethanIP        |
|                                     | QSGMII PCS                           | MorethanIP        |
|                                     | 2.5 Gbps Ethernet MAC                | MorethanIP        |
|                                     | EtherNET/IP                          | Softing AG        |
|                                     | EtherCAT (Software Stack)            | Softing AG        |
|                                     | <b>High Speed</b>                    |                   |
|                                     | Serial RapidIO <sup>®1</sup>         | Altera            |
|                                     | Common Public Radio Interface (CPRI) | Altera            |
|                                     | Interlaken                           | Altera            |
|                                     | SerialLite II                        | Altera            |
|                                     | SerialLite III                       | Altera            |
|                                     | SATA 1.0/SATA 2.0                    | Intelliprop, Inc. |
| QPI                                 | Intel Corporation                    |                   |
| HyperTransport™ 3.0                 | University of Heidelberg             |                   |



|                                     | Product Name  | Vendor Name           |
|-------------------------------------|---|-----------------------|
| Interface and Protocols (Continued) | <b>PCI</b>  |                       |
|                                     | PCIe Gen1 x1 <sup>1</sup> , x4 <sup>1</sup> , x8 Controller (Soft IP) | Altera                |
|                                     | PCIe Gen1 and Gen2 x1, x4, and x8 Lane (Hard IP)                      | Altera                |
|                                     | PCI Compiler, 32 bit Master/Target                                    | Altera                |
|                                     | PCI Compiler, 32 bit Target   | Altera                |
|                                     | PCIe Controller   | CAST, Inc.            |
|                                     | PCIe x8 Controller  | CAST, Inc.            |
|                                     | PCI 32/64 bit PCI Master/Target 33/66 MHz Controllers                 | CAST, Inc.            |
|                                     | PCI Multifunction Target Interface                                    | CAST, Inc.            |
|                                     | PCIe Gen1 x1, x4, x8 Controller                                       | Northwest Logic, Inc. |
|                                     | PCIe Complete Core x1, x4, x8   | Northwest Logic, Inc. |
|                                     | PCI-X Controller  | Northwest Logic, Inc. |
|                                     | Integrated PCI Core   | Northwest Logic, Inc. |
|                                     | PCI Interface   | Northwest Logic, Inc. |
|                                     | PCIe, Gen1, Gen2, and Gen3  | PLDA                  |
|                                     | PCI and PCI-X Master / Target Cores 32/64 bit                         | PLDA                  |
|                                     | <b>Serial</b>   |                       |
|                                     | Serial Peripheral Interface (SPI) <sup>2</sup>                        | Altera                |
|                                     | SPI/Avalon <sup>®</sup> Master Bridge <sup>2</sup>                    | Altera                |
|                                     | UART <sup>2</sup>   | Altera                |
| JTAG UART <sup>2</sup>              | Altera  |                       |

|                                     | Product Name   | Vendor Name             |
|-------------------------------------|--|-------------------------|
| Interface and Protocols (Continued) | JTAG/Avalon Master Bridge <sup>2</sup>               | Altera                  |
|                                     | C_CAN <sup>1</sup>                                   | Bosch                   |
|                                     | I <sup>2</sup> C Bus Controller <sup>1</sup>         | CAST, Inc.              |
|                                     | I <sup>2</sup> C Bus Controller Slave                | CAST, Inc.              |
|                                     | CAN <sup>1</sup>                                     | CAST, Inc.              |
|                                     | Local Interconnect Network (LIN) Controller          | CAST, Inc.              |
|                                     | SPI Master/Slave                                     | CAST, Inc.              |
|                                     | H16450S UART   | CAST, Inc.              |
|                                     | H16550S UART   | CAST, Inc.              |
|                                     | H16750S UART   | CAST, Inc.              |
|                                     | MD5  | CAST, Inc.              |
|                                     | Smart Card Reader                                    | CAST, Inc.              |
|                                     | DI2CM I <sup>2</sup> C Bus Interface-Master          | Digital Core Design     |
|                                     | DI2CSB I <sup>2</sup> C Bus Interface-Slave          | Digital Core Design     |
|                                     | D16550 UART with 16-Byte FIFO                        | Digital Core Design     |
|                                     | DSPI Serial Peripheral Interface Master/Slave        | Digital Core Design     |
|                                     | Secure Digital (SD)/MMC SPI                          | El Camino GmbH          |
|                                     | Secure Digital I/O (SDIO)/SD Memory/Slave Controller | Eureka Technology, Inc. |
|                                     | UART   | Eureka Technology, Inc. |
|                                     | SDIO/SD Memory/ MMC Host Controller                  | Eureka Technology, Inc. |
|                                     | Nios II Advanced CAN <sup>1</sup>                    | IFI                     |
|                                     | MediaLB Device Interface <sup>1</sup>                | IFI                     |
|                                     | I <sup>2</sup> C Master/Slave/PIO Controller         | Microtronix, Inc.       |
|                                     | USB 1.1 Host/Device                                  | Microtronix, Inc.       |

<sup>1</sup>Qsys-compliant licensed core.<sup>2</sup>Qsys component (no license required).

|   | Product Name   | Vendor Name      |
|---|--|------------------|
| Interface and Protocols (Continued)           | I <sup>2</sup> C Master and Slave                                | SLS              |
|   | PS2 Interface  | SLS              |
|   | USB High-Speed Function Controller <sup>1</sup>                  | SLS              |
|   | USB Full/Low-Speed Function Controller <sup>1</sup>              | SLS              |
|   | SD Host Controller <sup>1</sup>                                  | SLS              |
|   | USB 3.0 SuperSpeed Device Controller                             | SLS              |
|   | <b>Audio and Video</b>   |                  |
|   | Character LCD <sup>2</sup>                                       | Altera           |
|   | Pixel Converter (BGR0 -> BGR) <sup>2</sup>                       | Altera           |
|   | Video Sync Generator <sup>2</sup>                                | Altera           |
|   | Asynchronous Serial Interface (ASI)                              | Altera           |
|   | SD/HD/3G-HD serial digital interface (SDI)                       | Altera           |
|   | DisplayPort  | Altera           |
|   | DisplayPort  | Bitec            |
|   | V-by-One HS  | Bitec            |
|   | Video LVDS Serializer/Deserializer (SERDES) Transmitter/Receiver | Microtronic, Inc |
|   | I2S Audio CODEC <sup>1</sup>                                     | SLS              |
|   | <b>DMA</b>   |                  |
|   | Scatter Gather DMA Controller <sup>2</sup>                       | Altera           |
| DMA Controller <sup>2</sup>                   | Altera   |                  |
| DMA for Hard PCIe (EZDMA2)                    | PLDA   |                  |
| <b>Flash</b>                                  |  |                  |
| CompactFlash (True IDE) <sup>2</sup>          | Altera   |                  |
| EPCS Serial Flash Controller <sup>2</sup>     | Altera   |                  |
| Flash Memory <sup>2</sup>                     | Altera   |                  |
| NFlashCtrl NAND Flash Memory Controller       | CAST, Inc.   |                  |
| NAND Flash Controller                         | Eureka Technology, Inc.  |                  |
| ISA/PC Card/PCMCIA/ CompactFlash Host Adapter | Eureka Technology, Inc.  |                  |
| ONFI Controller                               | SLS  |                  |
| CompactFlash Interface <sup>1</sup>           | SLS  |                  |

|   | Product Name   | Vendor Name           |
|---|--|-----------------------|
| Memories and Memory Controllers (Continued) | <b>SDRAM</b>   |                       |
|   | DDR / DDR2 and DDR3 SDRAM Controllers <sup>1</sup>     | Altera                |
|   | LPDDR2 SDRAM Controller                                | Altera                |
|   | RLDRAM 2 Controller                                    | Altera                |
|   | Streaming Multi-Port SDRAM Memory Controller           | Microtronix, Inc.     |
|   | HyperDrive Multi-Port DDR2 Memory Controller           | Microtronix, Inc.     |
|   | Avalon Multi-Port SDRAM Memory Controller <sup>1</sup> | Microtronix, Inc.     |
|   | DDR and DDR2 SDRAM Controllers                         | Northwest Logic, Inc. |
|   | RLDRAM II and III Controllers                          | Northwest Logic, Inc. |
|   | Mobile DDR SDRAM Controller                            | Northwest Logic, Inc. |
|   | Mobile SDR SDRAM Controller                            | Northwest Logic, Inc. |
|   | SDR SDRAM Controller                                   | Northwest Logic, Inc. |
|   | LPDDR2 / 3 Controllers                                 | Northwest Logic, Inc. |
|   | <b>SRAM</b>  |                       |
|   | SSRAM (Cypress CY7C1380C) <sup>2</sup>                 | Altera                |
| QDR II / II+ SRAM Controller                | Altera   |                       |

<sup>1</sup>Qsys-compliant licensed core.

<sup>2</sup>Qsys component (no license required).

Altera device transceivers support the protocols listed in the following table. For details about the data rates, please visit [www.altera.com/datarates](http://www.altera.com/datarates).

| Protocols                                   | Supported Devices    |      |       |       |       |                    |         |      |       |       |                      |         |       |
|---|----------------------|------|-------|-------|-------|--------------------|---------|------|-------|-------|----------------------|---------|-------|
|   | Stratix Series FPGAs |      |       |       |       | Arria Series FPGAs |         |      |       |       | Cyclone Series FPGAs |         |       |
|   | V GX/GS              | V GT | IV GX | IV GT | II GX | V GX               | V GT/ST | V GZ | II GX | II GZ | V GX/SX              | V GT/ST | IV GX |
| Basic (proprietary)                         | ✓                    | ✓    | ✓     | ✓     | ✓     | ✓                  | ✓       | ✓    | ✓     | ✓     | ✓                    | ✓       | ✓     |
| CEI-6G-SR/LR                                | ✓                    | ✓    | ✓     | ✓     | ✓     | ✓                  | ✓       | ✓    | -     | -     | -                    | -       | -     |
| CEI-11G-SR/LR                               | ✓                    | ✓    | -     | ✓     | -     | -                  | -       | -    | -     | -     | -                    | -       | -     |
| CEI-25G-LR                                  | -                    | ✓    | -     | -     | -     | -                  | -       | -    | -     | -     | -                    | -       | -     |
| CEI-28G-SR/VSR                              | -                    | ✓    | -     | -     | -     | -                  | -       | -    | -     | -     | -                    | -       | -     |
| CEI-56G/VSR                                 | -                    | -    | -     | -     | -     | -                  | -       | -    | -     | -     | -                    | -       | -     |
| SFP+  | ✓                    | ✓    | -     | -     | -     | -                  | -       | ✓    | -     | -     | -                    | -       | -     |
| XFI   | ✓                    | ✓    | -     | ✓     | -     | -                  | ✓       | -    | -     | -     | -                    | -       | -     |
| XFP   | ✓                    | ✓    | -     | -     | -     | -                  | -       | ✓    | -     | -     | -                    | -       | -     |
| 1000BASE-X (GbE)                            | ✓                    | ✓    | ✓     | ✓     | ✓     | ✓                  | ✓       | ✓    | ✓     | ✓     | ✓                    | ✓       | ✓     |
| 10GBASE-R                                   | ✓                    | ✓    | -     | ✓     | -     | -                  | ✓       | ✓    | -     | -     | -                    | -       | -     |
| 10GBASE-KR                                  | ✓                    | ✓    | -     | -     | -     | -                  | -       | -    | -     | -     | -                    | -       | -     |
| ASI   | ✓                    | ✓    | ✓     | ✓     | ✓     | ✓                  | ✓       | -    | ✓     | ✓     | -                    | -       | -     |
| CPRI  | ✓                    | ✓    | ✓     | ✓     | ✓     | ✓                  | ✓       | ✓    | ✓     | ✓     | ✓                    | ✓       | ✓     |
| CAUI / XLAUI                                | ✓                    | ✓    | -     | ✓     | -     | -                  | -       | -    | -     | -     | -                    | -       | -     |
| CAUI-4                                      | -                    | ✓    | -     | -     | -     | -                  | -       | -    | -     | -     | -                    | -       | -     |
| DisplayPort                                 | ✓                    | ✓    | ✓     | ✓     | ✓     | ✓                  | ✓       | ✓    | -     | -     | ✓                    | ✓       | ✓     |
| Fibre Channel                               | ✓                    | ✓    | ✓     | ✓     | ✓     | ✓                  | ✓       | ✓    | -     | -     | -                    | -       | -     |
| GPON  | ✓                    | ✓    | ✓     | ✓     | -     | ✓                  | ✓       | ✓    | ✓     | ✓     | -                    | -       | -     |
| G.709 OTU-2                                 | ✓                    | ✓    | -     | ✓     | -     | ✓                  | ✓       | -    | -     | -     | ✓                    | ✓       | ✓     |
| OTN with FEC                                | ✓                    | ✓    | -     | ✓     | -     | -                  | -       | -    | -     | -     | -                    | -       | -     |
| HiGig                                       | ✓                    | ✓    | ✓     | ✓     | ✓     | ✓                  | ✓       | ✓    | ✓     | ✓     | -                    | -       | -     |
| High-Definition Multimedia Interface (HDMI) | ✓                    | ✓    | ✓     | ✓     | ✓     | ✓                  | ✓       | ✓    | ✓     | ✓     | ✓                    | ✓       | ✓     |

| Protocols           | Supported Devices    |         |          |          |          |                    |            |         |          |          |                      |            |          |
|---------------------|----------------------|---------|----------|----------|----------|--------------------|------------|---------|----------|----------|----------------------|------------|----------|
|                     | Stratix Series FPGAs |         |          |          |          | Arria Series FPGAs |            |         |          |          | Cyclone Series FPGAs |            |          |
|                     | V<br>GX/GS           | V<br>GT | IV<br>GX | IV<br>GT | II<br>GX | V<br>GX            | V<br>GT/ST | V<br>GZ | II<br>GX | II<br>GZ | V<br>GX/SX           | V<br>GT/ST | IV<br>GX |
| JESD204             | ✓                    | ✓       | ✓        | ✓        | ✓        | ✓                  | ✓          | ✓       | ✓        | ✓        | ✓                    | ✓          | ✓        |
| HMC                 | -                    | -       | -        | -        | -        | -                  | -          | -       | -        | -        | -                    | -          | -        |
| HyperTransport      | ✓                    | ✓       | ✓        | ✓        | -        | ✓                  | ✓          | ✓       | -        | -        | -                    | -          | -        |
| InfiniBand          | ✓                    | ✓       | -        | -        | -        | -                  | -          | ✓       | -        | -        | -                    | -          | -        |
| Interlaken          | ✓                    | ✓       | ✓        | ✓        | -        | ✓                  | ✓          | ✓       | -        | -        | -                    | -          | -        |
| MoSys               | -                    | -       | -        | -        | -        | -                  | -          | -       | -        | -        | -                    | -          | -        |
| OBSAI               | ✓                    | ✓       | ✓        | ✓        | ✓        | ✓                  | ✓          | ✓       | ✓        | ✓        | ✓                    | ✓          | ✓        |
| PCI Express         | ✓                    | ✓       | ✓        | ✓        | ✓        | ✓                  | ✓          | ✓       | ✓        | ✓        | ✓                    | ✓          | ✓        |
| RXAUI / DXAUI       | ✓                    | ✓       | ✓        | ✓        | ✓        | ✓                  | ✓          | ✓       | -        | -        | -                    | -          | -        |
| SGMII / QSGMII      | ✓                    | ✓       | ✓        | ✓        | ✓        | ✓                  | ✓          | ✓       | ✓        | ✓        | ✓                    | ✓          | ✓        |
| QPI                 | ✓                    | ✓       | -        | -        | -        | -                  | -          | ✓       | -        | -        | -                    | -          | -        |
| SAS / SATA          | ✓                    | ✓       | ✓        | ✓        | -        | ✓                  | ✓          | ✓       | ✓        | ✓        | ✓                    | ✓          | ✓        |
| SerialLite II / III | ✓                    | ✓       | ✓        | ✓        | -        | ✓                  | ✓          | -       | ✓        | ✓        | -                    | -          | -        |
| SDI                 | ✓                    | ✓       | ✓        | ✓        | ✓        | ✓                  | ✓          | ✓       | ✓        | ✓        | ✓                    | ✓          | ✓        |
| SFI-5.1             | ✓                    | ✓       | ✓        | ✓        | ✓        | ✓                  | ✓          | ✓       | -        | -        | -                    | -          | -        |
| SFI-S / SFI-5.2     | ✓                    | ✓       | -        | ✓        | -        | -                  | -          | ✓       | -        | -        | -                    | -          | -        |
| RapidIO             | ✓                    | ✓       | ✓        | ✓        | ✓        | ✓                  | ✓          | ✓       | ✓        | ✓        | ✓                    | ✓          | ✓        |
| SPAUI               | ✓                    | ✓       | ✓        | ✓        | ✓        | -                  | -          | ✓       | -        | -        | -                    | -          | -        |
| SONET / SDH         | ✓                    | ✓       | ✓        | ✓        | ✓        | ✓                  | ✓          | ✓       | ✓        | ✓        | -                    | -          | -        |
| XAUI (10GBASE-X)    | ✓                    | ✓       | ✓        | ✓        | ✓        | ✓                  | ✓          | ✓       | ✓        | ✓        | ✓                    | ✓          | ✓        |
| V-by-One            | ✓                    | ✓       | ✓        | ✓        | ✓        | ✓                  | ✓          | -       | -        | -        | -                    | -          | ✓        |

The following is a list of Altera and partner development kits. To get more details about these development kits or other older development kits that are available, check out our online selector guide at [www.altera.com/selector](http://www.altera.com/selector).

|                                       | Product and Vendor Name  | Device  | Description   |
|---------------------------------------|--|---|---|
| DSP                                   | DSP Development Kit, Cyclone III Edition <sup>1</sup><br><b>Altera</b>                   | Cyclone III EP3C120N  | This kit is for general DSP or wireless design engineers, regardless of whether you need pre-processing, DSP plus FPGA coprocessing, or post-processing. This kit includes complete 16 bit high-speed analog-to-digital (A/D) and digital-to-analog (D/A) converters (operating at up to 200 MSPS), as well as interfaces to TI DSP processors (DM642 and DaVinci). Altera's DSP Builder GUI simplifies the information flow between the FPGA toolset and MATLAB/Simulink (30-day evaluation copy included).  |
|                                       | Cyclone III Video and Image Processing Development Kit <sup>1</sup><br><b>Bitec</b>      | Cyclone III EP3C120N  | This kit is designed to help you start developing complex video applications. It supports various video I/O interfaces, allowing you to get your video data in and out of the Cyclone III FPGA. Different video interfaces are supported using the different daughtercards included in this kit: cards supporting Asynchronous Serial Interface (ASI) or SDI, composite, component, and digital video interfaces (DVI).   |
|                                       | Software Programmable Reconfiguration (SPR) Development System<br><b>BittWare</b>        | Cyclone III FPGA  | This development system provides a system platform to explore software reconfiguration of waveform functionality for high-end signal processing applications such as software-defined radio. The platform provides a flexible, portable, low-cost environment for software-defined radio development in an Advanced Mezzanine Card (AdvancedMC) and Micro Telecommunications Computing Architecture (MicroTCA) environment, enabling you to quickly and cost-effectively bring your waveform designs to life. |
|                                       | Audio Video Development Kit, Stratix IV GX Edition<br><b>Altera</b>                      | Stratix IV GX EP4SGX230   | This kit provides a complete video and image processing development environment for design engineers. It features the Stratix IV GX FPGA development board along with an SDI high-speed mezzanine card (HSMC) and associated reference designs.   |
|                                       | DSP Development Kit, Stratix III Edition<br><b>Altera</b>                                | Stratix III EP3SL150  | This kit comprises a Stratix III development board with a HSMC equipped with 16 bit A/D and D/A converters (operating at up to 200 MSPS). The HSMC also has interfaces to TI DSP processors, allowing the designs that use Stratix III FPGAs to be created both as stand-alone devices and as companion devices. The kit also contains Altera's Quartus II software, DSP Builder software, and a 30-day trial of MATLAB/Simulink.   |
|                                       | SC DVI Output Module<br><b>Bitec</b>   | Daughtercard  | This module supports all Altera development kits with Altera DVI expansion slots.   |
|                                       | THDB-ADA<br><b>Terasic Technologies, Inc.</b>  | Daughtercard  | This card provides dual A/D channels with 14 bit resolution with data rates up to 65 MSPS and dual D/A channels with 14 bit resolution with data rates up to 125 MSPS. It supports both Altera HSMC and Terasic DE-style connectors.  |
|                                       | HSMC Dual-Link DVI Board<br><b>Bitec</b>   | Daughtercard  | This daughtercard is a two-channel, dual-link DVI output board for Altera FPGA development kits with HSMC expansion port.   |
|                                       | SDI HSMC<br><b>Terasic Technologies, Inc.</b>  | Daughtercard  | This SDI HSMC card is for the development of SDI and AES systems based on transceiver-based host boards with HSMC connectors.   |
|                                       | DE3 Stratix III High Speed Rapid Prototyping System<br><b>Terasic Technologies, Inc.</b> | Stratix III EP3SL150F1152C2N<br>EP3SE260F1152C2N<br>EP3SL340F1152C2N  | This board is the perfect platform for creating your design in programmable logic. DE3 boards are available with either the EP3SL150, the EP3SL340, or the EP3SL260 (DE3-260) devices that are optimized with the extra on-chip multipliers needed for DSP research and development. All of the DE3 boards can be stacked and all feature the same connector for expanding the base functionality with daughtercards.   |
| OmniTek Audio Video<br><b>OmniTek</b> | Arria II GX EP2AGX125EF35  | This Arria II GX audio and video development kit combines Altera's proven FPGA-based development hardware and associated IP with OmniTek's expertise in video algorithm IP and PCIe interface design to offer a PCIe Gen1 image processing environment. |   |

<sup>1</sup>RoHS compliant.

|                  | Product and Vendor Name   | Device                            | Description  |
|------------------|---|-----------------------------------|--|
| DSP              | ProcHILs<br>GiDEL   | Stratix V<br>Stratix IV           | This development kit provides a state-of-the-art Hardware in the Loop acceleration tool for running Simulink designs on Altera's FPGAs. ProcHILs can automatically translate Simulink designs built using Altera's DSP Builder into FPGA code and run this code under Simulink. The generated code is compatible with the Proc board installed on the target PC and has the synchronization code needed to communicate with Simulink via PCIe.   |
| I/O Interconnect | Cyclone V GT FPGA Development Kit<br>Altera                       | Cyclone V GT<br>5CGTFD9E5F35C7N   | This kit can be used to prototype Cyclone V GT FPGA or Cyclone V GX FPGA applications. It offers a quick and simple way to develop low-cost and low-power system-level designs and achieve rapid results. This kit supports a myriad of functionalities, such as FPGA prototyping, FPGA power measurement, transceiver I/O performance up to 5 Gbps, PCIe Gen2 x4 (at 5 Gbps per lane), endpoint or rootport support.  |
|                  | Cyclone V E FPGA Development Kit<br>Altera                        | Cyclone V E<br>5CEFA7F31C7N       | The Cyclone V E Development Kit offers a comprehensive general-purpose development platform for many markets and applications, including industrial, networking, military, and medical applications. The kit features an Altera Cyclone V device and a multitude of onboard resources including multiple banks of DDR3 and LPDDR2 memory, LCD character display, LEDs, user switches, USB, and RJ-45 connectors. The Cyclone V E Development Kit gives industrial equipment designers greater flexibility in implementing real-time Ethernet communications with Industrial Ethernet IP cores. |
|                  | Cyclone IV GX FPGA Development Kit<br>Altera                      | Cyclone IV GX<br>EP4CGX150DF31C7N | This kit provides a comprehensive design environment that allows you to quickly develop low-cost and low-power FPGA system-level designs. This kit includes the PCIe short card form factor, two HSMC connectors, and a 10/100/1000 Mbps Ethernet interface. Onboard memory includes 128 MB DDR2 SDRAM, 64 MB flash, and 4 MB SSRAM. This kit also includes SMA connectors, and 50 MHz, 100 MHz, and 125 MHz clock oscillators, as well as user interfaces including push buttons, LEDs, and a 7-segment LCD display.  |
|                  | Arria II GX FPGA Development Kit, 6G Edition<br>Altera            | Arria II GX<br>EP2AGX125F1152     | This kit provides a full-featured hardware development platform for prototyping and testing high-speed serial interfaces to an Arria II GX FPGA up to 6 Gbps. This kit includes the PCIe x8 form factor, one HSMC connector, 128 MB 16 bit DDR3 SDRAM device, 1 GB 64 bit DDR2 SODIMM, 2 MB SSRAM, and 64 MB flash.  |
|                  | Arria II GX FPGA Development Kit<br>Altera                        | Arria II GX<br>EP2AGX125F1152     | This kit provides a full-featured hardware development platform for prototyping and testing high-speed serial interfaces to an Arria II GX FPGA. This kit includes the PCIe x8 form factor, one HSMC connector, 128 MB 16 bit DDR3 SDRAM device, 1 GB 64 bit DDR2 SODIMM, 2 MB SSRAM, and 64 MB flash.   |
|                  | Arria V GX FPGA Development Kit, Arria V GX Edition<br>Altera     | Arria V GX<br>5AGXFB3H6F40C6N     | This kit provides a full-featured hardware development platform for prototyping and testing high-speed serial interfaces to an Arria V GX FPGA. This kit includes two Arria V 5AGXFB3H6F40C6N FPGAs, the PCIe x8 form factor, two HSMC connectors, one FPGA mezzanine card (FMC) connector, 1,152 MB 72 bit DDR3 SDRAM, 4 MB 36 bit QDR II+ SRAM, flash memory, and two additional 32 bit DDR3 SDRAM devices. This kit also includes SMA connectors and a bull's-eye connector for differential transceiver I/Os.  |
|                  | Arria V GX Starter Kit, Arria V GX Edition<br>Altera              | Arria V GX<br>5AGXFB3H4F35C4      | This kit provides a low-cost platform for developing transceiver I/O-based Arria V GX FPGA designs. This kit includes the PCIe x8 form factor, one HSMC connector, a 32 bit DDR3 SDRAM device, one-channel high-speed transceiver input and output connected to SMAs, HDMI output, SDI input and output, 16x2 LCD display, and flash memory.   |
|                  | Transceiver Signal Integrity Kit, Stratix IV GX Edition<br>Altera | Stratix IV GX<br>EP4SGX230F1517   | This kit features eight full-duplex transceiver channels with SMA connectors, 156.25 MHz, 155.52 MHz, 125 MHz, 100 MHz, and 50 MHz clock oscillators, six user push buttons, eight dual in-line package (DIP) switches, eight user LEDs, a 7-segment LCD display, power and temperature measurement circuitry, and Ethernet, USB, and JTAG ports.  |

| Product and Vendor Name   | Device                           | Description  |
|---|----------------------------------|--|
| Transceiver Signal Integrity Kit, Stratix V GX Edition<br><b>Altera</b> | Stratix V GX<br>5SGXEA7N2F40C2N  | This kit enables a thorough evaluation of transceiver signal integrity and device interoperability. Features include seven full-duplex transceiver channels with SMA connectors, two 14G backplane connectors (from Amphenol and Molex), four programmable clock oscillators, four user push buttons, eight DIP switches, eight user LEDs, a 7-segment LCD display, power and temperature measurement circuitry, and Ethernet, an embedded USB Blaster download cable, and JTAG interfaces.  |
| 100G Development Kit, Stratix IV GT Edition<br><b>Altera</b>            | Stratix IV GT<br>EP4S100G5F4511N | This kit enables a thorough evaluation of 100G designs. It supports 10G/40G line interfaces through optical modules, and applications requiring external memory interfaces through four x18 QDR II and four x32 DDR3 memory banks. With this kit, you can evaluate transceiver performance up to 11.3 Gbps, verify PMA compliance to standards, such as 10G/40G/100G Ethernet, Interlaken, CEI-6G/11G, Serial RapidIO, PCIe (Gen1, Gen2, and Gen3), and other major standards. This kit can also validate interoperability between optical modules, such as small form factor pluggable (SFP), SFP+, quad small form factor pluggable (QSFP), and CFP.   |
| 100G Development Kit, Stratix V GX Edition<br><b>Altera</b>             | Stratix V GX<br>5SGXEA7N2F45C2N  | This kit enables a thorough evaluation of 100G designs. It supports 10G/40G line interfaces through optical modules, and applications requiring external memory interfaces through four x18 QDR II and four x32 DDR3 memory banks. With this kit, you can evaluate transceiver performance up to 11.3 Gbps, verify PMA compliance to standards, such as 10G/40G/100G Ethernet, Interlaken, CEI-6G/11G, Serial RapidIO, PCIe (Gen1, Gen2, and Gen3), and other major standards. This kit can also validate interoperability between optical modules, such as SFP, SFP+, QSFP, and CFP.  |
| Stratix IV GX FPGA Development Kit<br><b>Altera</b>                     | Stratix IV GX<br>EP4SGX230F1517  | This kit provides a full-featured hardware development platform for prototyping and testing high-speed serial interfaces to a Stratix IV GX FPGA. This kit includes the PCIe x8 form factor, two HSMC connectors for expandability, and Ethernet, USB, SDI, and HDMI interfaces. Memory includes one x64 DDR3 SDRAM, one x16 DDR3 SDRAM, two x18 QDR II+ SRAM, flash, and SSRAM. This kit also includes two SMA connectors for a differential transceiver output. Several oscillators are available at 156.25 MHz, 155.52 MHz, 125 MHz, 100 MHz, and 50 MHz. Other user interfaces include six user push buttons, eight DIP switches, eight user LEDs, 7-segment LCD display, and power and temperature measurement circuitry. |
| Stratix IV GX FPGA Development Kit, 530 Edition<br><b>Altera</b>        | Stratix IV GX<br>EP4SGX530F1517  | This kit provides a full-featured hardware development platform for prototyping and testing high-speed serial interfaces to a Stratix IV GX FPGA. This kit includes the PCIe x8 form factor, two HSMC connectors for expandability, and Ethernet, USB, SDI, and HDMI interfaces. Memory includes one x64 DDR3 SDRAM, one x16 DDR3 SDRAM, two x18 QDR II+ SRAM, flash, and SSRAM. This kit also includes two SMA connectors for a differential transceiver output. Several oscillators are available at 156.25 MHz, 155.52 MHz, 125 MHz, 100 MHz, and 50 MHz. Other user interfaces include six user push buttons, eight DIP switches, eight user LEDs, 7-segment LCD display, and power and temperature measurement circuitry. |
| Stratix V GX FPGA Development Kit<br><b>Altera</b>                      | Stratix V GX<br>5SGXEA7K2F40C2N  | This kit provides a full-featured hardware development platform for prototyping and testing high-speed serial interfaces to a Stratix V GX FPGA. This kit includes the PCIe x8 form factor, two HSMC connectors for expandability, and Ethernet, USB, and SDI interfaces. Memory includes one x72 DDR3 SDRAM, one x18 QDR II+ SRAM, and flash. This kit also includes two SMA connectors for a differential transceiver output. Several programmable oscillators are available and other user interfaces include three user push buttons, eight DIP switches, eight bi-color user LEDs, an LCD display, and power and temperature measurement circuitry.   |

I/O Interconnect (Continued)

| Product and Vendor Name                     | Device                            | Description   |
|---|-----------------------------------|---|
| S5-6U-VPX (S56X)<br>BittWare                | Stratix V GX/GS                   | This rugged 6U VPX card is based on Altera’s Stratix V GX/GS FPGAs and when combined with BittWare’s Anemone FPGA coprocessor, the ARM Cortex-A8 control processor, and the ATLANTIS FrameWork FPGA development kit, it creates a flexible and efficient solution for high-performance signal processing and data acquisition. The board provides a configurable 48-port multi-gigabit transceiver interface supporting a variety of protocols, including Serial RapidIO, PCIe, and 10GbE. Additional I/O interfaces include Ethernet, RS-232, JTAG, and LVDS. The board features up to 8 GB of DDR3 SDRAM as well as flash memory for booting the FPGAs. Two VITA 57-compliant FMC sites provide additional flexibility for enhancing the board’s I/O and processing capabilities. |
| S4-3U-VPX (S43X)<br>BittWare                | Stratix IV GX                     | This commercial or rugged 3U VPX card is based on Altera’s Stratix IV GX FPGA that is designed specifically for serial I/O-based applications, creating a completely flexible, reconfigurable VPX board. BittWare’s ATLANTIS FrameWork and the FINE Host/Control Bridge greatly simplify application development and integration of this powerful board. The board provides a configurable 25-port SERDES interface supporting a variety of protocols, including Serial RapidIO, PCIe, and 10GbE. The board also features 10/100/1000 Ethernet, and up to 4 GB of DDR3 SDRAM. The VITA 57-compliant FMC site provides enhanced flexibility, which supports 10 SERDES, 60 LVDS pairs, and 6 clocks.  |
| GT-3U-VPX<br>BittWare                       | Stratix II GX<br>EP2SGX90FF150814 | This ruggedized 3U CompactPCI board is designed for demanding multiprocessor applications requiring complete flexibility and adaptability. It features an Altera Stratix II GX FPGA, a front panel interface supplying four channels of high-speed SERDES transceivers, and a back panel interface providing RS-232/RS-422 and 10/100 Ethernet. Simultaneous onboard and offboard data transfers can be achieved at a rate of 2 Gbps. It also provides 1 GB of DDR2 SDRAM and 64 MB of flash memory for booting the FPGA and DSP devices.   |
| GT-3U-cPCI Compact<br>PCI Board<br>BittWare | Stratix II GX<br>EP2SGX90         | This ruggedized hybrid signal processing board features a Stratix II FPGA, a TigerSHARC DSP cluster, DDR2 SDRAM/QDR SDRAM, flash memory, and an external I/O throughput of 2 Gbps achieved via BittWare’s ATLANTIS FrameWork.   |
| GT-6U-VME<br>BittWare                       | Stratix II GX<br>EP2SGX90FF150814 | This ruggedized 6U VME/VXS (VITA 41) board is designed for demanding multiprocessor-based applications. The hybrid processing architecture takes advantage of both FPGA and DSP technology to provide a complete solution for applications requiring flexibility and adaptability along with high-end signal processing. The board features two high-density Stratix II GX FPGAs, a front panel interface supplying four channels of high-speed SERDES transceivers, and an extensive back panel interface including VXS. The board can achieve simultaneous onboard and offboard data transfers at a rate of 5 Gbps. It also provides up to 3 GB of DDR2 SDRAM, as well as 128 MB of flash memory for booting the FPGAs and DSP devices.   |
| S5-PCIe-HQ (S5PH-Q)<br>BittWare             | Stratix V GX/GS                   | This half-length PCIe x8 card is based on Altera’s Stratix V GX or GS FPGA and is a versatile and efficient solution for high-performance network processing, signal processing, and data acquisition. Combining it with BittWare’s Anemone coprocessor and ATLANTIS FrameWork enhances productivity and portability, and allows even greater processing efficiency. Over 16 GB of onboard memory includes DDR3 SDRAM and QDR II/ II+ SRAM. Two front-panel QSFP+ cages provide additional flexibility for serial I/O, allowing two 40GbE interfaces (or eight 10GbE), direct to the FPGA for reduced latency, making it ideal for high-frequency trading and networking applications.  |
| S5-PCIe-DR (S5PE-DR)<br>BittWare            | Stratix V GX/GS                   | This PCIe x16 card features two high-bandwidth, power-efficient Altera Stratix V GX or GS FPGAs and is a flexible and efficient solution for high-performance network processing, signal processing, and data acquisition. Combining it with BittWare’s Anemone coprocessor and ATLANTIS FrameWork enhances productivity and portability and allows even greater processing efficiency. The board provides up to 64 GB of DDR3 SDRAM and 576 MB of RLDRAM 3. Four front-panel QSFP+ cages provides additional flexibility, allowing four 40GbE interfaces (or twelve 10GbE), direct to the FPGAs for reduced latency, making it ideal for high-frequency trading and networking applications.   |

I/O Interconnect (Continued)



| Product and Vendor Name      | Device                      | Description  |
|------------------------------|-----------------------------|--|
| S5-PCIe (S5PE)<br>BittWare   | Stratix V GX/GS             | This PCIe x8 card is based on Altera's Stratix V GX or GS FPGA and is designed for high-performance network processing, signal processing, and data acquisition. Combining it with BittWare's Anemone coprocessor and ATLANTiS FrameWork enhances productivity and portability and allows even greater processing efficiency. The board provides up to 32 GB of DDR3 SDRAM with optional ECC. An optional VITA 57 FMC site provides additional flexibility for enhancing the board's I/O and processing capabilities, making it ideal for analog I/O and processing. The board also has the option of two front-panel QSFP+ cages for serial I/O, which support 10G per lane direct to the FPGA for reduced latency, making it ideal for high frequency trading and networking applications. It is also available with A/D and D/A conversion options.   |
| SP/D4-AMC (D4AM)<br>BittWare | Stratix IV                  | This board features the I/O processing power of two Altera Stratix IV FPGAs and is a mid- or full-size, single-width AdvancedMC that can be attached to AdvancedTCA carriers or other cards equipped with AMC bays, and used in MicroTCA systems. An Altera Stratix IV GX FPGA paired with a Stratix IV E FPGA makes the D4AM an extremely high-density, flexible board. The FPGAs are connected by two full-duplex 2 GB per second lanes of parallel I/O for data sharing. Each FPGA supports BittWare's ATLANTiS FrameWork to greatly simplify application development and integration. A VITA 57-compliant FMC site provides enhanced flexibility, which connects directly to the Stratix IV E FPGA for LVDS and to the Stratix IV GX FPGA for SERDES. The board also provides an IPMI system management interface and a configurable 18-port AMC SERDES interface supporting a variety of protocols. Onboard memory includes up to 1 GB of DDR3 SDRAM and 128 MB of flash memory, and Ethernet is available via the AMC front and rear panels. It is also available with A/D and D/A conversion options.   |
| SP/S4-AMC (S4AM)<br>BittWare | Stratix IV GX               | This board is based on Altera's Stratix IV FPGA and is a mid- or full-size, single-width AdvancedMC that can be attached to AdvancedTCA carriers or other cards equipped with AMC bays, and used in MicroTCA systems. The S4AM features a high-density, low-power Altera Stratix IV GX FPGA designed specifically for serial I/O-based applications, creating a completely flexible, reconfigurable AMC. Providing enhanced flexibility is the VITA 57-compliant FMC site, which features 8 SERDES, 80 LVDS pairs, and 6 clocks directly to the FPGA. BittWare's ATLANTiS FrameWork, in conjunction with the FINE III Host/Control Bridge, greatly simplifies application development and integration of this powerful board. The board also provides an IPMI system management interface, a configurable 15-port AMC SERDES interface supporting a variety of protocols, and a front panel 4x SERDES interface supporting CPRI and OBSAI. Additionally, the board features 10/100 Ethernet, GbE, two banks of DDR3 SDRAM, two banks of QDR II+ SRAM, and flash memory for booting the FPGAs and FINE. It is also available with A/D and D/A conversion options. |
| GX-AMC<br>BittWare           | Stratix II GX FPGA          | This mid-size, single-width AdvancedMC can be attached to Advanced Telecommunications Computing Architecture (AdvancedTCA) carriers or other cards equipped with AdvancedMC bays, and used in MicroTCA systems. The GXAM features a high-density Altera Stratix II GX FPGA, BittWare's ATLANTiS FrameWork (implemented in the FPGA), a front-panel I/O interface, a control plane interface via BittWare's FINE interface bridge, an IPMI system management interface, and a configurable x8 SERDES interface supporting a variety of protocols. It also provides 10/100 Ethernet, GbE, two banks of DDR2 SDRAM, one bank of QDR II SRAM, and flash memory for booting the FPGA and FINE.  |
| B2-AMC<br>BittWare           | Stratix II<br>EP2S90F1020C3 | This board supports universal baseband processing for wireless communication infrastructures, such as 2G, 2.5G, 3G, WiMAX, and software-defined radio. It attaches to AdvancedTCA carriers or other cards equipped with AdvancedMC bays, and is completely hot-swappable. It uses an Altera Stratix II FPGA, and provides a 10/100/1000 Ethernet interface for command, control, and reprogramming, as well as flash memory for booting the DSP devices and FPGAs.   |

I/O Interconnect (Continued)

|   | Product and Vendor Name   | Device   | Description  |
|---|---|--|--|
| I/O Interconnect (Continued)                              | 4S-XMC (4SXM)<br><b>BittWare</b>  | Stratix IV GX  | This is a single-width switched mezzanine card (XMC), designed to provide powerful FPGA processing and high-speed serial I/O capabilities to VME, VXS, VPX, cPCI, AdvancedTCA, or PCIe carrier boards. The 4SXM features a high-density, low-power Altera Stratix IV GX FPGA, which was designed specifically for serial I/O-based applications and is PCI-SIG® compliant for PCIe Gen1 and Gen2. Four SFP compact optical transceivers are available on the front panel. There are 8 multi-gigabit serial lanes supporting PCIe, Serial RapidIO, and 10GbE available via the board's rear panel, as well as 44 general-purpose digital I/O signals. The 4SXM also provides QDR II+ SRAM and flash memory. |
|   | S4GX-AMC<br><b>BittWare</b>   | Stratix IV GX<br>EP4SGX230F1517  | This board is based on Altera's Stratix IV GX FPGA and is a mid-size, single-width AdvancedMC that can be attached to AdvancedTCA carriers or other cards equipped with AdvancedMC bays, and used in MicroTCA systems. This board has two banks of DDR3 SDRAM (up to 1 GB each), and two banks of QDR II SRAM (up to 9 MB). Includes IP support for Serial RapidIO, PCIe, GbE, 10G Ethernet (XAUI), CPRI, and OBSAI interfaces.  |
|   | SF/GX-AMC<br><b>BittWare</b>  | Stratix II GX<br>EP2SGX130   | This board is based on Altera's Stratix II GX FPGA and is a full-size, single-width AdvancedMC that can be attached to AdvancedTCA carriers or other cards equipped with AdvancedMC bays, and used in MicroTCA systems. The SF/GX-AMC has all the features of the GX-AMC card and includes four SFP or SFP+ compact optical transceiver connectors.  |
|   | Ethernet USB Expansion Kit<br><b>Microtronix Inc.</b>   | Daughtercard   | This kit includes a wireless 802.11b CompactFlash card and a Microtronix CompactFlash board.   |
|   | I <sup>2</sup> C Design Kit<br><b>Microtronix Inc.</b>  | Daughtercard   | This kit provides an easy way to design, develop, and test the Microtronix I <sup>2</sup> C IP core.   |
|   | 10/100/1000 Ethernet PHY<br>Daughter Board with<br>Marvell PHY<br><b>MorethanIP</b>           | Daughtercard   | This kit provides the ability to implement high-speed Ethernet PHY solutions for prototyping and evaluation and embedded software development.   |
|   | 10/100/1000 Ethernet PHY<br>Daughter Board with<br>Texas Instruments PHY<br><b>MorethanIP</b> | Daughtercard   | This kit provides the ability to implement fast Ethernet solutions for prototyping and evaluation and embedded software development.   |
|   | SFP HSMC<br><b>Terasic Technologies, Inc.</b>   | Daughtercard   | This SFP HSMC is for the development of SGMII Ethernet, Fibre Channel, CPRI/OBSAI, and SONET designs based on transceiver-based host boards with HSMC connectors.  |
|   | Xpress GX4 Kit<br><b>PLDA</b>   | Stratix IV GX<br>EP4SGX230KF40C2N  | This kit provides a complete hardware and software environment for Altera Stratix IV GX FPGAs. It is built around a PCI form factor card compliant with PCI-SIG and targets the development of designs using PCIe Gen1 or Gen2.  |
|   | PCI-X Development Board<br><b>Terasic Technologies, Inc.</b>                                  | Cyclone III FPGA   | This board provides a hardware platform for developing and prototyping low-power, high-performance, logic-intensive PCI-based designs on an Altera Cyclone III FPGA. External memory is provided to facilitate the development of designs that need extra storage capacity or higher bandwidth memory. It also includes a LVDS interface using high-speed Terasic connectors (HSTCs) for high-speed interface applications.  |
|   | Xpress AGX2 Kit<br><b>PLDA</b>  | Arria II GX<br>EP2AGX125EF35   | This kit provides a complete hardware and software environment for Altera Arria II GX FPGAs. It is built around a PCI form factor card compliant with PCI-SIG and targets the development of designs using PCIe Gen1.  |
| Xpress AGX Kit<br><b>PLDA</b>                             | Arria GX<br>EP1AGX60DF780C6   | This kit provides a complete hardware and software environment for Altera Arria GX FPGAs. It is built around a PCI form factor card compliant with PCI-SIG and targets the development of designs using PCIe Gen1.   |  |
| Cyclone IV GX Transceiver<br>Starter Kit<br><b>Altera</b> | Cyclone IV GX<br>EP4CGX15   | This kit provides a low-cost platform for developing transceiver I/O-based FPGA designs. It includes the complete hardware and software you need to develop your FPGA design for cost-sensitive applications. You can measure the FPGA's power consumption, test the signal quality of the FPGA transceiver I/Os (up to 2.5 Gbps), and develop and test PCIe Gen1 designs. |  |

|                              | Product and Vendor Name  | Device                                  | Description   |
|------------------------------|--|---|---|
| I/O Interconnect (Continued) | Transceiver Signal Integrity Development Kit, Stratix IV GT Edition<br><b>Altera</b> | Stratix IV<br>EP4S100G2F40I1N           | This kit enables a thorough evaluation of transceiver interoperability and SERDES signal integrity by allowing you to evaluate transceiver performance up to 11.3 Gbps. You can generate and check pseudo-random binary sequence (PRBS) patterns via a simple-to-use GUI, change differential output voltage ( $V_{od}$ ), pre-emphasis, and equalization settings to optimize transceiver performance for your channel, perform jitter analysis, verify PMA compliance to 40G/100G Ethernet, Interlaken, CEI-6G/11G, PCIe (Gen1, Gen2, and Gen3), Serial RapidIO, and other major standards, and validate interoperability between optical modules.                                |
|                              | TREX S2 Prototyping System<br><b>Terasic Technologies, Inc.</b>                      | Stratix II FPGA                         | This Stratix II FPGA prototyping system provides almost 700 user I/Os and high-speed I/O connections. This board is flexible and configurable, and it provides default motherboards for free—with schematic and design libraries for you to develop your own motherboards.  |
|                              | QuickUSB Starter Kit<br><b>Bitwise Systems</b>                                       | Cyclone II<br>EP2C20F256C7              | This kit includes one QuickUSB module and one QuickUSB Cyclone II Evaluation Board. The evaluation board has a QuickUSB module site on headers that provide access to the signals. The EP2C20F256C7 FPGA connects to nearly every pin of the QuickUSB module, and extra I/O pins go to the headers so you can wire in your circuitry. The kit gets its power from the USB bus, but if you need more power, there is a power connector and a 5V 2A power supply included in the kit.   |
|                              | C3 Digital Radio Kit<br><b>CEPD</b>  | Cyclone III EP3C16                      | This kit aids the development and testing of algorithms and signal processing applications including digital radio, modulator/demodulator development, software-defined radio, high-speed data acquisition and signal processing, and audio data acquisition and signal processing. The acquired signals are sampled and then digitally processed by a Cyclone III FPGA. The FPGA card comes with a JTAG programming connector and a configuration PROM to retain the FPGA settings. The PCI card provides interfaces for the FPGA card to a computer PCI bus, RS232 interface, and user push buttons and includes a digital radio reference design example and full documentation. |
|                              | Cyclone III FPGA/<br>PCI Development Board<br><b>CEPD</b>                            | Cyclone III<br>EP3C16F484C8N            | This board provides a platform for fast and easy prototyping and design verification with the Cyclone III EP3C16F484C8N FPGA. It can be accessed either through the PCI bus or powered as a stand-alone system and accessed through an RS232 port. It comes with an onboard configuration PROM to retain the FPGA settings, an RS232 level shifter, voltage monitor, oscillator, buttons, and LEDs. There is a prototyping area on the board for user circuits and all FPGA pins are accessible through connectors and clearly labeled test points. The connectors are designed to mate with other CEPD daughterboards.   |
|                              | XpressGXII Kit<br><b>System Level Solutions</b>                                      | Stratix II GX<br>EP2S-<br>GX130FF1508C3 | This kit provides a complete hardware and software environment for Altera Stratix II GX FPGAs. It is built around a PCI form factor card compliant with PCI-SIG and targets the development of designs using PCIe Gen1.   |
|                              | SuperUSBC3-55<br><b>PLDA</b>   | Cyclone III<br>EP3C55U484C6N            | This kit provides a low-cost hardware and software environment for prototyping and deploying SuperSpeed USB applications. It targets the Altera Cyclone III FPGA (EP3C55F484C6N) and includes everything you need to implement a complete USB 3.0 subsystem.  |
|                              | A01 LVDS FPGA AMC<br><b>Dallas Logic</b>   | Arria GX<br>EP1AGX60                    | This LVDS transceiver card features the Arria GX FPGA in the F780 BGA package. The backplane interface is user configurable to support several interface standards including PCIe, Serial RapidIO, and GbE. The front panel VHDCI connector supports 28 transmit and 28 receive LVDS links sourced from the FPGA (and two clock signals for each transmit and receive connector). Additional features include two 512-Kb x36 synchronous SRAMs, an IPMI 1.5-compliant Module Management Controller (MMC), a 32 Mb serial flash memory, two onboard temperature sensors, USB communication and debug interface, and a 32 bit Mictor debug connector.                                 |
|                              | Stratix IV GX/GT 40G/<br>100G Interlaken<br><b>HiTech Global</b>                     | Stratix IV<br>EP4S100G5<br>EP4SGX530    | This board integrates the most fundamental electrical and optical interfaces for building 200G subsystems. It implements CAUI and Interlaken high-speed serial interfaces, industry-leading, high-speed DDR3 SDRAM and QDR II+ SRAM interfaces, and high-speed parallel interconnect for NetLogic knowledge-based processors (KBPs). The modular design enables expansion to support legacy and emerging optical modules.   |

|                              | Product and Vendor Name                         | Device   | Description  |
|------------------------------|---|--|--|
| I/O Interconnect (Continued) | HD FIFO Modules<br><b>Averlogic</b>             | Daughtercard   | This board is designed for evaluating the AL460A HD-FIFO. It has two embedded AL460A-7-PBF (or AL460A-13-PBF) devices operating in parallel, expanding the bus width to 32 bits. Control signals and data bus signals are available on two 50-pin connectors. A separate adaptor board (HSMC interface) is available for connecting the module directly to a Cyclone III FPGA Starter Kit.   |
|                              | Broadcast Video Card<br><b>Bitec</b>            | Daughtercard   | This card is designed for professional video equipment developers. The dual ASI/SD-SDI interfaces allow access to industry-standard video transport signals. Based on the latest adaptive cable equalizers and drivers, the ASI/SDI interfaces provide excellent noise immunity up to cable lengths of 350 meters. A voltage-controlled crystal oscillator (VCXO) allows precise synchronization to incoming ASI signals. A DVB-T reference design using the Bitec BVDC daughtercard and a Cyclone III FPGA Development Kit is available.  |
|                              | Quad Video Board<br><b>Bitec</b>                | Daughtercard   | This board is based on the Texas Instruments TVP5154 quad video decoder. The analog video inputs include composite video and S-video. Video output is based on the Chrontel CH7010B device, enabling single-link DVI, component analog, and composite analog outputs. The device accepts digital, parallel video data, and clocking from the host FPGA via the HSMC connector, which configures and monitors the device over an I <sup>2</sup> C link. A DVI output connector and mini-DIN output connector are provided.  |
|                              | HDMI Receiver/Transmitter<br><b>Microtronix</b> | Daughtercard   | This daughtercard interfaces a HDMI receiver and transmitter to your Altera FPGA development kit using the HSMC expansion connector. The receiver also supports an analog component video (YCbCr) interface. The card uses the Analog Devices AD9889 HDMI Transmitter and AD9880 HDMI Receiver to support HDTV formats up to 1080p at 60 Hz. The receiver offers the flexibility of both an analog interface and an HDMI receiver integrated on a single chip.   |
|                              | Quad Link LVDS Interface<br><b>Microtronix</b>  | Daughtercard   | This daughtercard supports receive and transmit LVDS links, each consisting of five data channels and one clock for a total of 48 LVDS channels. The standard configuration of 20 TX + 4 clk and 20 RX + 2 clk, is capable of supporting LCD display panels up to 1080p at 100/120 Hz. Onboard LVDS termination resistors can be removed to convert receiver channels into transmitters as required to support 12 bit or 14 bit color applications. It is used for capturing LVDS video data, connecting to a camera link interface, or for connecting to LCD panels using LVDS, mini-LVDS, RSDS, and PPDS low-voltage panel interface signaling.  |
|                              | CX4 to HSMC Adapter<br><b>MorethanIP</b>        | Daughtercard   | This passive daughtercard for 10GbE CX-4 copper interconnect prototyping features a four-lane differential 3.125 Gbps connector (CX-4) for 10GbE IEEE 802.3ak, a 160-pin HSMC to the main board, and compatibility with Stratix II GX mother boards that use HSMC connectors.  |
|                              | PROCe V<br><b>GiDEL</b>                         | Stratix V GX/GS (Gen3 x8)<br>5SGXMA3K2F40C3N<br>5SGXMA7K2F40C2N<br>5SGSMD8K2F40C2N   | This half-length PCIe x8 card is based on Altera's Stratix V GX or GS FPGA and is a versatile and efficient solution for high-performance network processing, signal processing, and data acquisition. Combining it with GiDEL's PROCWizard software and data management IP cores, enhances productivity and portability, and allows even greater processing efficiency. The platform features 16+ GB of onboard memory includes DDR3 SDRAM and SRAM. Typical sustain throughput of 8,000 GBps for internal memories and 25+ GBps for onboard memory. Networking capabilities include one CXP connector cage suitable for 100GbE Ethernet (100GBASE-CR10, 100GBASE-SR10), 3x40 GbE, or single Infiniband 12xQDR link, two SFP+ cage suitable for 10 GbE, and Optical Transport Network. Additional I/O interfaces, 2x high-speed inter-board connectors (up to 12x14.1Gb/s full duplex GPIO) for board to board and proprietary daughterboards connectivity. |
| ProcE<br><b>GiDEL</b>        | EP4S820E<br>EP3S340L<br>EP2S60F1020C4N          | This Altera-based PCIe x4 platform is ideal for high-speed data acquisition, algorithmic acceleration, IP validation, and verification of small SoCs. This board has five levels of memory structure (8.5 GB+) with maximum sustain throughput of 4,693 GBps for internal memories and 12 GBps for DRAM. |  |

|                              | Product and Vendor Name   | Device  | Description  |
|------------------------------|---|---|--|
| I/O Interconnect (Continued) | ProcFG<br>GiDEL   | Stratix V GX<br>Stratix IV E<br>Stratix III L/E | This kit is based on Altera's Stratix FPGA. It is used for development of vision algorithms, machine vision, and medical imaging applications. ProcFG combines high-speed acquisition, powerful FPGA processing with selective on-the-fly ROI offloading for convenient processing on standard PC. The ProcFG captures all incoming image data or dynamically targets and extracts ROIs based on real-time FPGA analysis of the incoming data, and supports acquisition from both line and area scan cameras.  |
|                              | PROCel LP<br>GiDEL  | Stratix II<br>EP2S60<br>EP2S180                 | PROCel LP board provides a low-profile Stratix II-based FPGA platform for high-speed data acquisition systems, vision systems, DSP applications, and powerful reconfigurable computing. The FPGA, the memory, and the daughterboards' flexible architecture (system I/O etc.) of the PROCel system, enable you to build complex designs at affordable price.   |
|                              | ProcPBX8<br>GiDEL   | Stratix II GX<br>EP2SGX30                       | The PBX8 platform is ideal for IP designers to cost-effectively prototype logic and memory designs. It includes the PCIe and PIPE interface with data or clock recovery technology. An optional stand-alone mode includes the availability of four XAUI channels, each with a data rate of 3.125 Gbps. Also available are parallel RapidIO or user-defined high-speed I/O interface for various applications.  |
| Embedded                     | Cyclone V GT FPGA<br>Development Kit<br>Altera                                    | Cyclone V GT<br>5CGTFD9E5F35C7N                 | This kit can be used to prototype Cyclone V GT FPGA or Cyclone V GX FPGA applications. It offers a quick and simple way to develop low-cost and low-power system-level designs and achieve rapid results. This kit supports a myriad of functionality, such as FPGA prototyping, FPGA power measurement, transceiver I/O performance up to 5.0 Gbps, PCIe Gen2 x4 (at 5.0 Gbps per lane), endpoint or rootport support.  |
|                              | Cyclone V E FPGA<br>Development Kit<br>Altera                                     | Cyclone V E<br>5CEFA7F31C7N                     | The Cyclone V E Development Kit offers a comprehensive general-purpose development platform for many markets and applications, including industrial, networking, military, and medical applications. The kit features an Altera Cyclone V device and a multitude of onboard resources, including multiple banks of DDR3 and LPDDR2 memory, LCD character display, LEDs, user switches, USB, and RJ-45 connectors. The Cyclone V E Development Kit gives industrial equipment designers greater flexibility in implementing real-time Ethernet communications with Industrial Ethernet IP cores.                |
|                              | Cyclone V SoC<br>Development Kit<br>Altera  | Cyclone V SoC<br>5CSXFC6D6F31C8NES              | The Altera Cyclone V SoC Development Kit offers a quick and simple approach to develop custom ARM processor-based SoC designs accompanied by Altera's low-power, low-cost Cyclone V FPGA fabric. This kit supports a wide range of functions, such as processor and FPGA prototyping and power measurement, industrial networking protocols, motor control applications, acceleration of image- and video-processing applications, PCIe x4 lane with ~1,000 MBps transfer rate (endpoint or rootport).   |
|                              | Industrial Networking Kit<br>Terasic Technologies, Inc.                           | Cyclone IV E<br>EP4CE115                        | The Industrial Networking Kit (INK) offers a comprehensive development platform for industrial automation and applications. The kit consists of the DE2-115 board featuring the Altera Cyclone IV device and dual 10/100/1000-Mbps Ethernet, 128 MB SDRAM, 8 MB flash memory, 2 MB SRAM, HSMC and GPIO connectors, USB 2.0, an SD card slot, switches and buttons, LEDs, 16x2 display, audio and video, and VGA-out. The kit also includes an Industrial Communications Board (ICB-HSMC) that supports RS-485, RS-232, CAN, and additional I/O expansion.  |
|                              | Nios II Embedded Evaluation<br>Kit,<br>Cyclone III Edition <sup>1</sup><br>Altera | Cyclone III<br>EP3C25N                          | This kit includes a complete hardware and software design environment for a 32 bit microcontroller plus FPGA evaluation. Beginners can check out the pre-built, eye-catching demos displayed on the LCD touch screen or do some lightweight development. Advanced microcontroller designers can learn about the latest techniques, multiprocessor systems, or about designing a complete system in 30 minutes.   |
|                              | Cyclone III FPGA<br>Development Kit<br>Altera                                     | Cyclone III<br>EP3C120N                         | This kit contains 8 MB SSRAM, 256 MB DDR2 SDRAM, 64 MB flash, configuration via USB, 10/100/1000 Ethernet and USB ports, onboard oscillators and SMAs, graphics LCD and character LC displays, two HSMC expansion connectors, three HSMC debug cards, and onboard power measurement circuitry. Complete documentation including reference designs: <i>Create Your First FPGA Design in an Hour</i> and <i>Measure Cyclone III FPGA Power</i> . This kit also includes Quartus II Web Edition design software, an evaluation edition of Nios II processor plus related design suite, and the Altera IP library. |

<sup>1</sup> RoHS compliant.

|                      | Product and Vendor Name  | Device                                   | Description   |
|----------------------|--|--|---|
| Embedded (Continued) | Nios II Development Kit, Cyclone III Edition <sup>1</sup><br><b>Altera</b> | Cyclone III EP3C120N                     | The unique combination of high-performance embedded processor power and easy-to-use integrated design software has been updated to take advantage of Cyclone III devices, the industry's lowest cost, first-to-market 65 nm FPGA family. This development kit provides an ideal environment for developing and prototyping a wide range of price-sensitive, high-performance embedded applications.   |
|                      | Lancelot VGA IP Design Kit<br><b>Microtronix Inc.</b>                      | Daughterboard                            | This kit includes a small hardware board with a 24 bit RAMDAC, VGA connector, stereo audio connector, and two PS/2 connectors.  |
|                      | Compact Flash Expansion Kit<br><b>Microtronix Inc.</b>                     | Daughterboard                            | This inexpensive module allows the addition of compact flash cards to the Microtronix Product Starter Kit development board system.   |
|                      | Low-Power Reference Platform<br><b>Arrow</b>                               | Cyclone III EP3C25<br>MAX IIG EPM240T100 | This platform uses the low-power Altera Cyclone III FPGAs and MAX IIG CPLDs. It demonstrates how to minimize power consumption in portable and battery-powered embedded systems and gives you the flexibility to create application-specific low-power solutions.   |
|                      | BeMicro SDK<br><b>Arrow</b>  | Cyclone IV E EP4CE22F17C7N               | This Arrow BeMicro SDK enables a quick and easy evaluation of soft core processors for both embedded software developers and hardware engineers. The kit builds on the success of the original BeMicro evaluation kit by adding features, such as Mobile DDR memory, Ethernet, and even the option of using a file system by slotting in a micro-SD card. The BeMicro SDK connects to a PC via a USB connection, which is used for power, programming, and debug. Arrow has a number of reference designs and pre-built software templates that can be downloaded for this kit that highlight the benefits of building embedded systems in FPGAs. |
|                      | MimoKit<br><b>Cosis</b>  | Stratix II EP2S180F1020C5 x2             | This kit is designed for extensively networked embedded applications that require wireless LAN connectivity and GbE. It provides the multiple-input multiple-output (MIMO) RF and analog front end consisting of two major sub-blocks. The analog block is made of three IQ CODECs that perform the conversions between the digital and analog domains. The radio block consists of three 2.4 GHz/5 GHz dual-band radio transceivers.   |
|                      | ARM-MPS<br><b>Gleichmann Electronics</b>                                   | Stratix III                              | This platform offers total flexibility for prototyping your ARM Cortex-M3-based designs. It allows unrestricted access to the latest ARM Cortex-M-class processors. It is delivered with a comprehensive range of tools that allow fast and easy system design—drag and drop the supplied IP components to configure the system, or implement your own system blocks. Then synthesize the design and update the board with a single mouse-click. The tool suite also includes system configuration utilities and a JTAG signal monitor together with software development tools and a JTAG debug probe.   |
|                      | CMCS002M Controller FPGA Module<br><b>Dallas Logic</b>                     | Cyclone III EP3C25                       | This module allows you to implement general logic functions and Nios II processor operations in a compact form factor module. The module uses the Cyclone III EP3C25 FPGA, 512K x8 SRAM, EP1S16 FPGA serial loader (FPGA and Nios II processor boot), and a USB 2.0 peripheral port (low-/full-speed operation). This module also supports the Cardstac specification (master or slave standard card, 128 pins), and can interface with other modules designed to that specification.   |
|                      | ProcCamSim<br><b>GiDEL</b>   | Stratix III EP3SE80-F1152-C2             | ProcCamSim is a development kit based on Altera's Stratix III E FPGAs. It is a high-performance camera or machine simulator, that generates video and test patterns to a frame grabber supporting all the Camera Link v1.1 specification (base, medium, and full) configurations. Typical applications include vision algorithms development, image processing, application testing, machine vision integration, vision system reliability testing and debug of "rarely appearing bugs." The development kit supports Bitmap Image File (.bmp) and raw image files and enables video simulation via streaming of .bmp or raw images.              |

<sup>1</sup> RoHS compliant.

|                      | Product and Vendor Name            | Device   | Description   |
|----------------------|------------------------------------|--|---|
| Embedded (Continued) | PROC104<br>GiDEL                   | Stratix IV E<br>Stratix III L<br>Stratix III E | This is a PCIe/104 standard Altera-based platform incorporating compact, self-stacking, and rugged industrial-standard connectors. This powerful platform is ideal for high-performance FPGA development and deployment across a range of size, weight, and power-constrained (SWaP-constrained) application areas, including signal intelligence, image processing, software-defined radio, and autonomous modules, or vehicles. The PROC104 can be hosted via 4-lane PCIe and is stackable. The board's high-speed performance coupled with memory and add-on daughterboards' flexible architecture enable the system to meet almost any computational needs. In addition to 512 MB onboard memory, two SODIMM sockets provide up to 8 GB of memory.  |
|                      | PROCStar IV<br>GiDEL               | EP4SE530H35C2N<br>(1 - 4 FPGAs)                | This full-length PCIe x8 card is based on Altera's Stratix IV E FPGAs. It provides a high-capacity, high-speed FPGA-based platform fortified with high throughput and massive memory resulting in a powerful and highly flexible system. The performance, memory, and add-on daughterboards' flexible architecture enable the system to meet almost any computation needs. In addition to 2 GB onboard memory, 8 SODIMM sockets provide up to 32 GB of memory or additional connectivity and logic. The largest FPGA-based supercomputer at the National Science Foundation Center for High-Performance Reconfigurable Computing (NSF CHREC) center houses 100 of these cards (400 Altera FPGAs) and is used for Bio-RC, HFT, data mining, and seismic analysis applications.   |
| ASIC Prototyping     | DN7020k10<br>The Dini Group        | Stratix III<br>Stratix IV                      | This complete logic prototyping system gives ASIC and IP designers a vehicle to prototype logic and memory designs using up to 20 Stratix III or Stratix IV devices.  |
|                      | DN7006K10PCIe-8T<br>The Dini Group | Stratix III<br>Stratix IV                      | This complete logic prototyping system with a dedicated PCIe interface gives ASIC and IP designers a vehicle to prototype logic and memory designs using up to six Stratix III or Stratix IV devices.   |
|                      | DIGILAB SX III<br>El Camino GmbH   | Stratix III                                    | This universal FPGA prototyping platform based on Altera's largest Stratix III devices supports 2 MB flash, 2 MB SRAM, four Samtec expansion connectors, two Mictor connectors, user LEDs, and push buttons along with RS-232, SPI, and USB interfaces.   |
|                      | PROCStar II, ProcStar III<br>GiDEL | Stratix II<br>Stratix III                      | This system provides high-capacity, high-speed, multi-FPGA-based prototyping and end system platforms.  |
|                      | ProcSoC3-4S system<br>GiDEL        | Stratix IV<br>EP4SE820F43C3                    | PROC_SoC Verification System provides scalability of multiple interconnected FPGA modules, enabling verification of SoC designs from 6 million to 360 million equivalent ASIC gates. Each ProcSoC module itself is a modular and scalable SoC verification system. Fast GbE connection combined with GiDEL's development tools enable it to run the target software or regression suites via remote servers connected to the SoC/ASIC design. The remote operation is performed at near actual system speed allowing for hardware-software integration and co-verification. Two chassis configurations are available, ProcSoC3 and ProcSoC10, capable of supporting up to 3 or 10 PROC12M boards, respectively. Each ProcSoC system can prototype a single SoC or be partitioned to prototype multiple designs in parallel. The ProcSoC's unique interconnectivity topology enables any FPGA to connect directly to any other FPGA in the system even in large systems. |
|                      | ProcE<br>GiDEL                     | EP4S820E<br>EP3S340L<br>EP2S60F1020C4N         | This Altera-based PCIe x4 platform is ideal for high-speed data acquisition, algorithmic acceleration, IP validation, and verification of small SoCs. This board has five levels of memory structure (8.5 GB+) with maximum sustain throughput of 4,693 GBps for internal memories and 12 GBps for DRAM.  |

|                              | Product and Vendor Name  | Device   | Description   |
|------------------------------|--|--|---|
| ASIC Prototyping (Continued) | DNMEG S2GX Stratix II GX-Based ASIC Prototyping Kit<br><b>The Dini Group</b> | Stratix II GX                                  | This logic emulation daughtercard enables ASIC or IP designers to cost-effectively prototype logic and memory designs. The DNMEGS2GX is hosted on any DN7000 or DN8000 series ASIC Dini Group product, but can also be used alone.  |
|                              | Single-FPGA (Tile) Prototyping Solution<br><b>Polaris Design Systems</b>     | Stratix IV                                     | This single-FPGA prototyping board can accommodate up to 15 million gate designs. It has a single Stratix IV FPGA and 18 Mb of SRAM. The board can be used either in a rack-mountable system or as a stand-alone unit.  |
|                              | Multi-FPGA (Logic) Prototyping Solution<br><b>Polaris Design Systems</b>     | Stratix IV                                     | This multi-FPGA prototyping board can accommodate up to 30 million gate designs. The board has three Stratix IV FPGAs, SRAM, and 2 GB of DDR3 SDRAM (expandable to 8 GB). The board can be used either in a rack-mountable system or as a stand-alone unit.   |
|                              | DN7002k10MEG<br><b>The Dini Group</b>  | Stratix IV<br>EP4SE820F43CxN<br>EP4SE530F43CxN | This complete logic emulation system allows you to prototype SoC logic and memory designs. It can operate as a stand-alone system, or be hosted via a USB interface. A single system, configured with two Stratix IV EP4SE820 FPGAs, can emulate up to 13 million gates. All FPGA resources are available for the target application. Each FPGA position can use any available speed grade.   |
|                              | DN7406k10PCIe-8T<br><b>The Dini Group</b>                                    | Stratix IV<br>EP4SE820F43CxN<br>EP4SE530F43CxN | This complete logic prototyping system allows you to prototype logic and memory designs. The DN7406k10PCIe-8T is hosted in an eight-lane PCIe Gen1 bus, but can be used as a stand-alone system configured via USB or CompactFlash. A single board configured with six Altera Stratix IV EP4SE820 FPGAs can emulate up to 31 million gates. All of the FPGA resources are available for your application, and any combination of speed grades can be used.  |
|                              | DNMEG S2GX<br><b>The Dini Group</b>  | Stratix II GX<br>EP2SGX90EF1152C3N             | This daughtercard enables you to prototype logic and memory designs. It is hosted on any DN8000- or DN7000-series ASIC emulation products from the Dini Group, but can be used as a stand-alone system. It contains the Stratix II GX EP2SGX90 (speed grades -5, -4, or -3) and can emulate over 600K gates. One DDR2 SDRAM SODIMM is provided, allowing the FPGA to address up to 2 GB of memory.  |
|                              | Stratix IV E FPGA Development Kit<br><b>Altera</b>                           | Stratix IV E<br>EP4SE530                       | This kit allows rapid and early development of designs for high-performance Stratix IV FPGAs. The development board provides general I/Os that connect to onboard switches and indicators, and to the included two-line LCD and 128 x 64 graphics display. The board also has non-volatile and volatile memories (64 MB flash, 4 MB pseudo-SRAM, 36 Mb QDR II SRAM, 128 MB DDR2 DIMM, and 16 MB DDR2 device), HSMC, and 10/100/1000 Ethernet interfaces. The kit is delivered with Quartus II software and all of the cabling required to start using the board straight out of the box.  |
|                              | Stratix III FPGA Development Kit<br><b>Altera</b>                            | Stratix III<br>EP3SL150                        | This kit allows rapid and early development of designs for high-performance Stratix III FPGAs. The development board provides general I/Os that connect to onboard switches and indicators, and to the included two-line LCD and 128 x 64 graphics display. The board also has non-volatile and volatile memories (64 MB flash, 4 MB pseudo-SRAM, 36 Mb QDR II SRAM, 128 MB DDR2 DIMM, and 16 MB DDR2 device), HSMC, and 10/100/1000 Ethernet interfaces. The kit is delivered with Quartus II software and all of the cabling required to start using the board straight out of the box. |



|   | Product and Vendor Name   | Device  | Description   |
|---|---|---|---|
| General Purpose   | Cyclone V GT FPGA Development Kit<br><b>Altera</b>                          | Cyclone V GT<br>5CGTFD9E5F35C7N   | This kit can be used to prototype Cyclone V GT FPGA or Cyclone V GX FPGA applications. It offers a quick and simple way to develop low-cost and low-power system-level designs and achieve rapid results. This kit supports a myriad of functionality, such as FPGA prototyping, FPGA power measurement, transceiver I/O performance up to 5 Gbps, PCIe Gen2 x4 (at 5 Gbps per lane), endpoint or rootport support.   |
|   | Cyclone V E FPGA Development Kit<br><b>Altera</b>                           | Cyclone V E<br>5CEFA7F31C7N   | The Cyclone V E FPGA Development Kit offers a comprehensive general-purpose development platform for many markets and applications, including industrial, networking, military, and medical applications. The kit features an Altera Cyclone V device and a multitude of onboard resources including multiple banks of DDR3 and LPDDR2 memory, LCD character display, LEDs, user switches, USB, and RJ-45 connectors. The Cyclone V E Development Kit gives industrial equipment designers greater flexibility in implementing real-time Ethernet communications with Industrial Ethernet IP cores. |
|   | Stratix V Advanced Systems Development Kit<br><b>Altera</b>                 | Stratix V<br>2x 5SGXEA7N-2F45C2N  | This kit is a complete systems design environment that includes both the hardware and software needed to begin architecture development and system design using Stratix V FPGA designs. The PCIe-based form-factor utilizes a x16 edge connector, and includes high memory bandwidth to DDR3, QDR II+, and serial memory. Multiple high-speed protocols are accessible through FMC and HMSC connections.  |
|   | Cyclone III FPGA Starter Kit <sup>1</sup><br><b>Altera</b>                  | Cyclone III<br>EP3C25N  | This kit contains 1 MB SSRAM, 16 MB DDR SDRAM, 16 MB parallel flash, configuration via USB, four user push buttons, four user LEDs, and power measurement circuitry. Complete documentation including reference designs: <i>Create Your First FPGA Design in a Hour</i> , <i>Measure Cyclone III FPGA Power</i> , and <i>Create Your First Nios II Design</i> . This kit also includes Quartus II Web Edition design software, the evaluation edition of Nios II processor plus related design suite, and Altera IP library.  |
|   | Video Development Kit<br><b>Bitec</b>                                       | Cyclone III FPGA  | This kit contains the Cyclone III FPGA Development Kit and two HSMC video interface cards together with a collection of IP cores and reference designs. The kit provides a variety of video interface standards including both digital and analog up to HD resolutions.   |
|   | ViClaro III HD Video Enhancement Development Platform<br><b>Microtronix</b> | Cyclone III FPGA  | This video enhancement development platform supports 100/120-Hz HDTV that is 1080p bandwidth-capable and features 32 bit DDR2 SDRAM memory, a HDMI transmitter, an analog/HDMI receiver, and dual LVDS links.   |
|   | MAX II Micro<br><b>Terasic Technologies, Inc.</b>                           | MAX II CPLD<br>EPM2210F324C3  | This kit, equipped with the largest Altera Max II CPLD and an onboard USB-Blaster cable, functions as a development and education board for CPLD designs. This kit also includes reference designs with source code.  |
|   | DIGILAB picoMAX Prototyping Board and Starter Kit<br><b>El Camino GmbH</b>  | MAX EPM3032A to<br>EPM7160S   | This MAX 3000/MAX 7000 starter kit includes downloading and programming hardware.   |
|   | DB3128<br><b>EBV</b>  | MAX<br>EPM3128A   | This low-cost MAX 3000A CPLD development board with 128 macrocells provides an easy entry point into Altera's CPLD technology.  |
|   | DB3256<br><b>EBV</b>  | MAX<br>EPM3256A   | This 5.2-megapixel camera daughtercard provides selectable frame rates and resolutions.   |
|   | PM410 StarFabric Compact PCI Carrier Board<br><b>Parsec</b>                 | MAX<br>EPM3256A   | This board consists of two 3.3 V PMC sites, 32/64 bit 33/66 MHz PCI buses, 2.5 Gbps StarFabric links on J3, and supports full PCI bandwidth.  |
| TRDB_DC2 1.3 Megapixel Camera Module<br><b>Terasic Technologies, Inc.</b> | Daughtercard  | This module consists of complete digital camera reference designs with source code in Verilog HDL and a user manual with live demo examples. It supports exposure, light control, and motion capture. |   |

<sup>1</sup> RoHS compliant.

|                             | Product and Vendor Name  | Device                    | Description   |
|-----------------------------|--|---------------------------|---|
| General Purpose (Continued) | TRDB_LCM Digital Panel Daughtercard<br><b>Terasic Technologies, Inc.</b>                       | Daughtercard              | This 3.6" digital panel development kit consists of reference designs (TV player and color pattern generator) with source code in Verilog HDL.  |
|                             | HSMC DVI Input/Output Module<br><b>Bitec</b>   | Daughtercard              | This DVI transmitter/receiver module for the HSMC interface enables you to interface FPGA projects to real-world DVI signals.   |
|                             | SC DVI Input Module<br><b>Bitec</b>  | Daughtercard              | This DVI module for the Santa Cruz interface enables you to interface FPGA projects to real-world DVI signals.  |
|                             | SC DVI Output Module<br><b>Bitec</b>   | Daughtercard              | This DVI module for the Santa Cruz interface enables you to drive high-resolution displays with digital clarity.  |
|                             | SC Camera<br><b>Bitec</b>  | Daughtercard              | This board features a 5.2-megapixel camera daughtercard with selectable frame rates and resolutions.  |
|                             | SC Proto<br><b>Bitec</b>   | Daughtercard              | This prototyping board for the Santa Cruz interface has convenient access points to power and ground with connector break-out.  |
|                             | Hpe-midiv2<br><b>Gleichmann Electronics</b>  | Stratix III EP3SL150      | This complete development environment provides a large number of onboard PHY and a range of child boards with various auxiliary functions for developing large and complex systems. It consists of a motherboard with the latest Stratix III FPGA modules and all of the latest interfaces on a single platform. It comes with a GUI for access to a set of free tools including system configuration utilities, JTAG debugger and scanner, and clock factory programmer. |
|                             | DE0 Development Board<br><b>Terasic Technologies, Inc.</b>                                     | Cyclone III EP3C16F484C6N | This board provides all the essential tools for you to learn about digital logic and FPGAs. It is equipped with an Altera Cyclone III EP3C16 FPGA, which offers 15,408 LEs. The board provides 346 user I/O pins and is loaded with a rich set of features. It is suitable for advanced university and college courses as well as the development of sophisticated digital systems, and includes software, reference designs, and accessories.                            |
|                             | DE1 Development Board<br><b>Terasic Technologies, Inc.</b>                                     | Cyclone II EP2C20 FPGA    | This board is a smaller version of the DE2 board. It is useful for learning about digital logic and FPGAs. Featuring an Altera Cyclone II EP2C20 FPGA, it is designed for university and college laboratory use, and is suitable for a wide range of exercises in courses on digital logic and computer organization.   |
|                             | DE2 Development Board<br><b>Terasic Technologies, Inc.</b>                                     | Cyclone II EP2C35 FPGA    | This board was designed by professors, for professors. It is an ideal vehicle for learning about digital logic and FPGAs. Featuring an Altera Cyclone II EP2C35 FPGA, the DE2 board is designed for university and college laboratory use. It is suitable for a wide range of exercises in courses on digital logic and computer organization.  |
|                             | DE2-70 Digital Camera and Multimedia Development Platform<br><b>Terasic Technologies, Inc.</b> | Cyclone II EP2C70F896C6N  | This board is a modified version of the Altera DE2 board with a larger FPGA and more memory. It is an excellent vehicle for learning about digital logic and FPGAs. Featuring an Altera Cyclone II EP2C70 FPGA, the DE2 board is designed for university and college laboratory use.  |
|                             | DE2-115 Development and Education Board<br><b>Terasic Technologies, Inc.</b>                   | Cyclone IV E EP4CE115     | This board is part of the DE2 educational development board series and features the Cyclone IV E EP4CE115 FPGA. The DE2-115 offers an optimal balance of low-cost, low-power and a rich supply of logic, memory and DSP capabilities, as well as interfaces to support mainstream protocols including GbE. A HSMC connector is provided to support additional functionality and connectivity via HSMC daughtercards and cables.   |

|                             | Product and Vendor Name   | Device                             | Description   |
|-----------------------------|---|------------------------------------|---|
| General Purpose (Continued) | MAX II/MAX IIZ Development Kit<br><b>System Level Solutions</b> | MAX II<br>EPM240<br>EPM240Z        | This board provides a hardware platform for designing and developing simple and low-end systems based on Altera MAX II/MAX IIZ devices. The board features a MAX II/MAX IIZ EPM240T100Cx/EPM240ZM100Cx device with 240 LEs and 8,192 bits of user flash memory (UFM). The board also supports vertical migration into EPM570T100Cx devices with 570 LEs and 8,192 bits of UFM.  |
|                             | MAX V CPLD Development Kit<br><b>Altera</b>                     | MAX V 5M570Z                       | This low-cost platform will help you quickly begin developing low-cost, low-power CPLD designs. Use this kit as a stand-alone board or combined with a wide variety of daughtercards that are available from third parties.   |
|                             | CoreCommander Development Kit<br><b>System Level Solutions</b>  | Cyclone III<br>EP3C25F256C8        | This kit features the Altera Cyclone III FPGA that provides more than enough room for almost any embedded design. This flexible board comes with a suite of SLS IP Cores, drivers, and application software. Delivered as a complete package, this kit ensures quick and easy implementation of industry-leading cores with reduced risk, at a very low cost.   |
|                             | Cyclone III LS FPGA Development Kit<br><b>Altera</b>            | Cyclone III LS<br>EP3CLS200F780C7N | This kit combines a high-density, low-power Cyclone III LS FPGA with a complete suite of security features implemented at the silicon, software, and IP levels. These security features provide passive and active protection of your IP from tampering, reverse engineering, and counterfeiting. It uses the EP3CLS200 FPGA—200K LEs at less than 0.25 W static power.   |
|                             | HSMC Prototyping Board<br><b>Bitec</b>                          | Daughtercard                       | This board provides a solution for prototyping circuits and testing them together with the latest Altera FPGA development kits. This board provides access to the complete set of HSMC signals via a footprint of standard 0.1" pitch headers. The HSMC power pins are accessed via fuses for added security. The main prototype matrix comprises a 0.1" grid interleaved with +3.3 V and GND access points. Footprints for commonly used 25-way and 9-way D-type connectors are included on the board.   |
|                             | ProcPAK II<br><b>GiDEL</b>                                      | Cyclone II<br>EP2C35               | ProcPAK II development kit is based on Altera's Stratix II FPGA platform. The development kit greatly improves time to market. There is no need to design the board, the PCI driver, or the application driver layer, define board constraints, design memory controller, and write environment FPGA code. This kit enables designers to focus on their proprietary value-added design instead of spending their valuable effort to recreate standard design components. With ProcMultiPort innovative memory controller, the generated HDL code enables high-speed, easy-to-use parallel access to large memories. |

**We offer an extensive curriculum of classes to deepen your expertise. Our classes are beneficial whether you're new to FPGA and CPLD design, or are an advanced user wanting an update on the latest tools, tips, and tricks. Choose a training path delivered in three different ways:**

- Instructor-led training, typically lasting one to two days, involves in-person instruction with hands-on exercises from an Altera or Altera partner subject matter expert. Fees vary.
- Virtual classrooms, involving live instructor-taught training over the Web, allow you to benefit from the interactivity with an instructor from the comfort of your home or office. Classes are taught in 4.5-hour sessions across consecutive days.
- Online training, typically one to two hours long, features pre-recorded presentations and demonstrations. Online classes are free and can be taken at any time.

To help you decide which courses might be most useful to you, we've grouped classes into specific curricula. Curricula paths include Altera FPGA Fundamentals, Software Developer, FPGA Designer, DSP Designer, Embedded Designer, and many more.

**Learn more about our training program or sign up for classes at [www.altera.com/training](http://www.altera.com/training). Start sharpening your competitive edge today!**

| Altera Instructor-Led and Virtual Classroom Courses<br>Virtual Classroom Courses Denoted with a *<br>(All Courses Are One Day in Length Unless Otherwise Noted) |  |   |
|---|--|---|
| Course Category   | General Description  | Course Titles   |
| <b>Design languages</b>   | Attain the skills needed to design with Verilog HDL and VHDL for programmable logic  | <ul style="list-style-type: none"> <li>• Introduction to VHDL*</li> <li>• Advanced VHDL Design Techniques*</li> <li>• Introduction to Verilog HDL*</li> <li>• Advanced Verilog HDL Design Techniques*</li> </ul>  |
| <b>Quartus II software</b>  | Acquire design entry, compilation, programming, verification, and optimization skills by learning how to use both basic and advanced features of Quartus II software | <ul style="list-style-type: none"> <li>• The Quartus II Software Design Series: Foundation*</li> <li>• The Quartus II Software Debug and Analysis Tools</li> <li>• The Quartus II Software Design Series: Timing Analysis*</li> <li>• Timing Closure with the Quartus II Software*</li> <li>• Advanced Timing Analysis with TimeQuest*</li> <li>• Design Optimization Using Quartus II Incremental Compilation*</li> <li>• Partial Reconfiguration with Altera FPGAs</li> </ul> |
| <b>Software development</b>   | Accelerate algorithm performance with Open Computing Language (OpenCL™) by offloading to an FPGA   | <ul style="list-style-type: none"> <li>• Parallel Computing with OpenCL Workshop*</li> </ul>  |
| <b>System integration</b>   | Build hierarchical systems by integrating IP and custom logic  | <ul style="list-style-type: none"> <li>• Introduction to the Qsys System Integration Tool</li> <li>• Advanced Qsys System Integration Tool Methodologies</li> </ul>   |
| <b>Embedded system design</b>   | Learn to design an ARM-based or Nios II processor system in an Altera FPGA   | <ul style="list-style-type: none"> <li>• Designing with the Nios II Processor</li> <li>• Developing Software for the Nios II Processor (2-day course)</li> <li>• Designing with an ARM-based SoC</li> <li>• Developing Software for an ARM-based SoC</li> </ul>   |
| <b>Memory interfaces</b>  | Implement interfaces to external memory  | <ul style="list-style-type: none"> <li>• Implementing, Simulating, and Debugging External Memory Interfaces*</li> </ul>   |
| <b>System design</b>  | Solve DSP and video system design challenges using Altera technology   | <ul style="list-style-type: none"> <li>• Designing with DSP Builder Advanced Blockset*</li> <li>• Video Design Framework Workshop</li> </ul>  |
| <b>Connectivity design</b>  | Build high-speed, gigabit interfaces using embedded transceivers found in leading-edge FPGA families   | <ul style="list-style-type: none"> <li>• Building Gigabit Interfaces in Altera Transceiver Devices</li> <li>• Creating PCI Express Links Using FPGAs</li> </ul>   |

| Altera Free Online Training Courses (Courses Are Approximately One Hour in Length) |   |                                |
|--|---|--------------------------------|
| Course Category  | Course Titles   | Languages                      |
| Getting started  | Read Me First!  | English, Chinese, and Japanese |
|  | Basics of Programmable Logic  | English, Chinese, and Japanese |
|  | How to Begin a Simple FPGA Design   | English, Chinese, and Japanese |
| Design languages   | VHDL Basics   | English and Chinese            |
|  | Verilog HDL Basics  | English and Chinese            |
|  | SystemVerilog with the Quartus II Software  | English, Chinese, and Japanese |
|  | Best HDL Design Practices for Timing Closure  | English, Chinese, and Japanese |
| Software overview and design entry   | Using the Quartus II Software: An Introduction  | English, Chinese, and Japanese |
|  | The Quartus II Software Interactive Tutorial  | English only                   |
|  | The Quartus II Software Design Series: Foundation (note: this training is equivalent to the instructor-led course of the same name) | English, Chinese, and Japanese |
|  | What's New in the Quartus II Software   | English and Japanese           |
|  | Setting Up Floating Licenses  | English only                   |
|  | Synplify Pro Tips and Tricks  | English only                   |
|  | Synplify Synthesis Techniques with the Quartus II Software  | English only                   |
|  | Using Quartus II Software: Schematic Design   | English and Chinese            |
|  | Introduction to Incremental Compilation   | English, Chinese, and Japanese |
|  | I/O System Design   | English, Chinese, and Japanese |
|  | Advanced I/O System Design  | English and Chinese            |
|  | Managing Metastability with the Quartus II Software   | English only                   |
| Partial Reconfiguration  | English only  |                                |
| Verification and debugging   | Overview of Mentor Graphics ModelSim Software   | English and Japanese           |
|  | SignalTap II Embedded Logic Analyzer: Getting Started   | English, Chinese, and Japanese |
|  | Using Quartus II Software: Chip Planner   | English only                   |
|  | Debugging and Communicating with an FPGA Using the Virtual JTAG Megafunction  | English only                   |
|  | System Console  | English and Chinese            |
|  | Debugging JTAG Chain Integrity  | English only                   |
|  | Power Analysis and Optimization   | English and Chinese            |
|  | Resource Optimization   | English only                   |

## Altera Free Online Training Courses (Courses Are Approximately One Hour in Length)

| Course Category             | Course Titles  | Languages                      |
|-----------------------------|--|--------------------------------|
| Timing analysis and closure | TimeQuest Timing Analyzer  | English, Chinese, and Japanese |
|                             | Timing Closure Using Quartus II Advisors and Design Space Explorer                   | English and Chinese            |
|                             | Timing Closure Using Quartus II Physical Synthesis Optimizations                     | English and Chinese            |
|                             | Timing Closure Using TimeQuest Custom Reporting                                      | English only                   |
|                             | Design Evaluation for Timing Closure   | English and Chinese            |
|                             | Good High-Speed Design Practices   | English only                   |
|                             | Constraining Source Synchronous Interfaces   | English and Chinese            |
|                             | Constraining Double Data Rate Source Synchronous Interfaces                          | English and Chinese            |
| Memory interfaces           | Using High-Performance Memory Interfaces in Altera FPGAs                             | English only                   |
| Connectivity design         | Transceiver Basics   | English, Chinese, and Japanese |
|                             | Transceiver Toolkit  | English only                   |
|                             | Transceiver Reconfiguration in Altera 28 nm Devices                                  | English only                   |
|                             | Decision Feedback Equalization and Adaptive Equalization in Stratix IV GX/GT Devices | English only                   |
|                             | Advanced Signal Conditioning for Stratix IV and Stratix V Receivers                  | English only                   |
|                             | Getting Started with Altera's 28 nm PCI Express Solutions                            | English only                   |
|                             | Getting Started with Altera's 40 nm PCI Express Solutions                            | English and Japanese           |
|                             | Custom Protocol Design in Altera 28 nm Devices                                       | English only                   |
|                             | Introduction to Altera's 10/100/1000 Mb Ethernet Solutions                           | English only                   |
|                             | Introduction to Altera's 10 Gb Ethernet Solutions                                    | English only                   |
|                             | High-Speed Serial Protocol Design with Altera Transceiver Devices                    | English and Chinese            |
|                             | Dynamic Reconfiguration in Altera Transceiver Devices                                | English and Chinese            |
| System design               | Introduction to Qsys   | English and Japanese           |
|                             | Advanced System Design Using Qsys  | English only                   |
|                             | Qsys Custom Components   | English only                   |
|                             | Designing with DSP Builder Advanced Blockset: An Overview                            | English and Chinese            |
|                             | Variable-Precision DSP Blocks in Altera 28 nm FPGAs                                  | English only                   |
|                             | Viterbi Decoder  | English only                   |
|                             | High-Performance Floating-Point Processing with FPGAs                                | English only                   |
|                             | Building Video Systems   | English only                   |
|                             | Implementing Video Systems   | English only                   |

Altera Free Online Training Courses (Courses Are Approximately One Hour in Length)

| Course Category              | Course Titles   | Languages                      |
|------------------------------|---|--------------------------------|
| System design<br>(continued) | Creating Reusable Design Blocks   | English only                   |
|                              | Using Cascaded-Integrator-Comb Filter in Multirate Digital Systems                        | English only                   |
|                              | FIR Compiler II   | English only                   |
|                              | Avalon Verification Suite   | English only                   |
| OpenCL                       | Introduction to Parallel Computing with OpenCL  | English and Chinese            |
|                              | Writing OpenCL Programs for Altera FPGAs  | English and Chinese            |
|                              | Running OpenCL on Altera FPGAs  | English and Chinese            |
| Embedded system<br>design    | Developing Software for the Nios II Processor: Tools Overview                             | English, Chinese, and Japanese |
|                              | Developing Software for the Nios II Processor: Design Flow                                | English and Chinese            |
|                              | SoC Hardware Overview - (Part 1)  | English, Japanese, and Chinese |
|                              | SoC Hardware Overview - (Part 2)  | English, Japanese, and Chinese |
|                              | Hardware Design Flow for an ARM-Based SoC   | English only                   |
|                              | Software Design Flow for an ARM-Based SoC   | English only                   |
|                              | Using the Nios II Processor   | English, Chinese, and Japanese |
|                              | Developing Software for the Nios II Processor: Nios II Software Build Tools for Eclipse   | English and Japanese           |
|                              | Nios II Software Build Tools for Eclipse and BSP Editor (Quartus II Software 10.0 Update) | English only                   |
|                              | Developing Software for the Nios II Processor: HAL Primer                                 | English, Chinese, and Japanese |
|                              | Developing Software for the Nios II Processor: Software Build Flow - (Part 1)             | English only                   |
|                              | Developing Software for the Nios II Processor: Software Build Flow - (Part 2)             | English only                   |
|                              | Nios II Floating-Point Custom Instructions  | English, Chinese, and Japanese |
|                              | Developing Software for the Nios II Processor: MMU and MPU                                | English and Chinese            |
|                              | Lauterbach Debug Tools  | English only                   |
| Introduction to Graphics     | English only  |                                |
| Device-specific<br>training  | Power Distribution Network Design for Stratix III and Stratix IV FPGAs                    | English and Chinese            |
|                              | Power Distribution Network Design Using Altera PDN Design Tools                           | English only                   |
|                              | Configuring Altera FPGAs  | English and Chinese            |
| Scripting                    | Command-Line Scripting  | English only                   |
|                              | Introduction to Tcl   | English and Chinese            |
|                              | Quartus II Software Tcl Scripting   | English and Japanese           |



Below is a glossary of helpful terms to bring you up to speed on Altera devices.

| Term   | Definition  |
|--|---|
| Adaptive logic module (ALM)                    | Logic building block, used by some Altera devices, which provides advanced features with efficient logic utilization. Each ALM contains a variety of look-up table (LUT)-based resources that can be divided between two combinational adaptive LUTs (ALUTs).   |
| Configuration via Protocol (CvP)               | CvP is a configuration method that enables you to configure the FPGA using industry-standard protocols. Currently CvP supports the PCIe protocol.   |
| Embedded HardCopy Blocks                       | These metal-programmable hard IP blocks deliver up to 14M ASIC gates or up to 700K additional LEs to harden standard or logic-intensive applications.   |
| Equivalent LE                                  | Device density represented as a comparable amount of LEs, which uses the 4-input LUT as a basis.  |
| Fractional phase-locked loops (Fractional PLL) | A phase-locked loop (PLL) in the core fabric, fractional PLLs provide increased flexibility as an additional clocking source for the transceiver, replacing external VCXOs.   |
| Global clock networks                          | Global clocks can drive throughout the entire device, serving as low-skew clock sources for functional blocks such as ALMs, DSP blocks, TriMatrix memory blocks, and PLLs. See regional clocks and periphery clocks for more clock network information.   |
| Hard processor system (HPS)                    | This processor system is a hardened component within the SoC, which comprises a dual-core ARM Cortex-A9 MPCore processor, a rich set of peripherals, and multiport memory controllers.  |
| Logic element (LE)                             | This logic building block, used by some Altera devices, includes a 4-input LUT, a programmable register, and a carry chain connection. See device handbooks for more information.   |
| Macrocells                                     | Similar to LEs, this is the measure of density in MAX series CPLDs.   |
| Memory logic array blocks (MLABs)              | MLABs are dual-purpose blocks, configurable as regular logic array blocks or as memory blocks.  |
| On-chip termination (OCT)                      | Support for driver impedance matching and series termination, which eliminates the need for external resistors, improves signal integrity, and simplifies board design. On-chip series, parallel, and differential termination resistors are configurable via Quartus II software.                              |
| Periphery clocks (PCLKs)                       | PCLKs are a collection of individual clock networks driven from the periphery of the device. PCLKs can be used instead of general-purpose routing to drive signals into and out of the device.  |
| Plug & Play Signal Integrity                   | This capability, consisting of Altera's adaptive dispersion engine and hot socketing, lets you change the position of backplane cards on the fly, without having to manually configure your backplane equalization settings.  |
| Programmable Power Technology                  | This feature automatically optimizes logic, DSP, and memory blocks for the lowest power at the required performance. Only the blocks with critical-path logic need to be in high-performance mode; all others are in low-power mode.  |
| Real-time in-system programming (ISP)          | This capability allows you to program a MAX II device while the device is still in operation. The new design only replaces the existing design when there is a power cycle to the device, so can perform in-field updates to the MAX II device at any time without affecting the operation of the whole system. |
| Regional clocks                                | Regional clocks are device quadrant-oriented and provide the lowest clock delay and skew for logic contained within a single device quadrant.   |
| System on a chip (SoC)                         | An SoC is an embedded system that consists of a processor, peripherals, and custom hardware integrated on a single device.  |
| Variable-precision blocks                      | These integrated blocks provide native support for signal processing of varying precisions—for example, 9x9, 27x27, and 18x36—in a sum or independent mode.   |



# Powering Your FPGA

# Powering Your Innovation

*Accelerate* your designs with simple, easy-to-design, low-noise power conversion solutions that save space and improve your board's reliability. The combination of our FPGAs and SoCs with our Enpirion PowerSoCs will provide you:

- 20% to 50% smaller footprint than alternative solutions
- High conversion efficiency and low thermal resistance
- 280,000 years mean time between failures (MTBF)
- Higher signal integrity with low ripple and low electromagnetic interference (EMI)
- High integration to minimize design effort

Unlike discrete products, Altera Enpirion PowerSoC solutions give you complete power systems that are fully simulated, characterized, and production qualified.

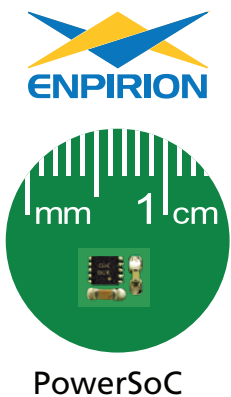

## Map of Technology Centers and Main Corporate Offices



### ● Technology Centers

#### **NORTH AMERICA:**

Toronto, Ontario, Canada  
Newfoundland, Nova Scotia, Canada  
San Jose, California, USA  
Hampton, New Jersey, USA  
Austin, Texas, USA

#### **EUROPE:**

Copenhagen, Denmark  
High Wycombe, U.K.

#### **ASIA:**

Shanghai, China  
Aswan, Egypt  
Penang, Malaysia

### ● Main Corporate Offices

#### **Altera Corporation**

101 Innovation Drive  
San Jose, CA 95134  
USA  
[www.altera.com](http://www.altera.com)

#### **Altera European Headquarters**

Holmers Farm Way  
High Wycombe  
Buckinghamshire  
HP12 4XF  
United Kingdom  
Telephone: (44) 1 494 602 000

#### **Altera Japan Ltd.**

Shinjuku I Tower 32F  
6-5-1, Nishi Shinjuku  
Shinjuku-ku, Tokyo 163-1332  
Japan  
Telephone: (81) 3 3340 9480  
[www.altera.co.jp](http://www.altera.co.jp)

#### **Altera International Ltd.**

Unit 11- 18, 9/F  
Millennium City 1, Tower 1  
388 Kwun Tong Road  
Kwun Tong  
Kowloon, Hong Kong  
Telephone: (852) 2 945 7000  
[www.altera.com.cn](http://www.altera.com.cn)



[www.altera.com/twitter](http://www.altera.com/twitter)



[www.altera.com/facebook](http://www.altera.com/facebook)



[www.alteraforum.com](http://www.alteraforum.com)



[www.youtube.com/alteracorp](http://www.youtube.com/alteracorp)



[www.linkedin.com/company/altera](http://www.linkedin.com/company/altera)



[plus.google.com/+altera](http://plus.google.com/+altera)



FSC logo

©2013 Altera Corporation. All rights reserved. ALTERA, ARRIA, CYCLONE, ENPIRION, HARDCOPY, MAX, MEGACORE, NIOS, QUARTUS and STRATIX words and logos are trademarks of Altera Corporation and registered in the U.S. Patent and Trademark Office and in other countries. All other words and logos identified as trademarks or service marks are the property of their respective holders as described at [www.altera.com/legal](http://www.altera.com/legal). November 2013  
SG-PRDCT-13.1