

For board-to-board	<h1 style="margin: 0;">P8 Series</h1>
Narrow pitch connectors (0.8mm pitch)	

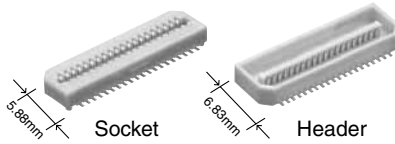

RoHS compliant

FEATURES

1. The product lineup includes low profile heights of 3.0 mm, 3.5 mm, 4.0 mm, 4.5 mm, 5.0 mm, 5.5 mm, 6.0 mm, 7.0 mm, 8.0 mm, 11.5 mm, and 13.0 mm 14.0 mm.
2. For the 11.5 mm version, both socket and header have the same shape.
Simplifies management of stock and delivery.

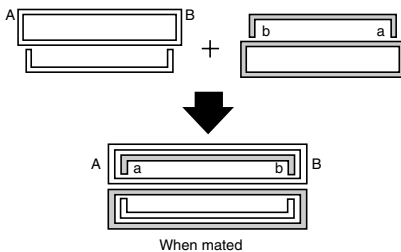

3. Ideal for portable devices, the bellows-type contacts provide a strong resistance against falling, impacts, and forced insertions and removals.

Bellows-type contacts

Bellows-type contacts resist mating stress and offer high contact reliability.

Ex.: Stacking height of 3.0 mm

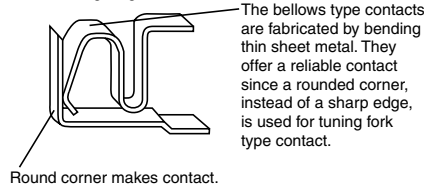

4. Porosity treatment for improved resistance against corrosion.

5. Simple lock mechanism

Lock mechanism ensures proper contact and provides resistance against vibrations and shocks.

3.0 mm, 3.5 mm, 4.0 mm, 4.5 mm, 5.0 mm, 5.5 mm, 6.0 mm, 7.0 mm, 8.0 mm, 13.0 mm, and 14.0 mm.

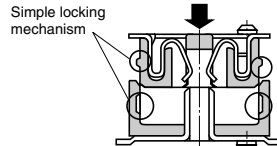

The simple lock mechanism is not featured on the 11.5 mm version. However, proper contact and resistance against vibrations and shocks are both ensured by the long mating length.

6. Automatic mounting (excluding 11.5 mm version)

1) Automatic mounting machine is available with an exclusive mounting nozzle.

Using the following types of suction nozzles make the connectors compatible with automatic mounting without the need for suction tape.

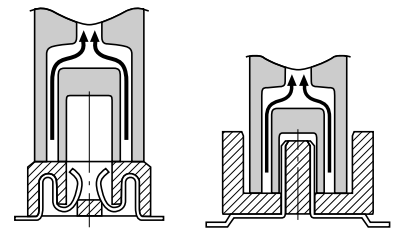

Suction tape and covers are also available for compatibility with other types of mounting machines.

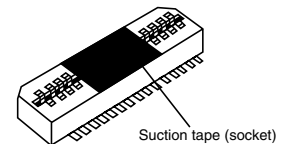

2) Positioning bosses (without bosses also available)

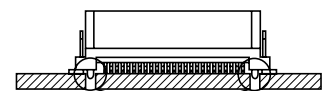

Bosses for positioning on the PC board (those without bosses are also available). Suitable for both manual and automatic mounting.

APPLICATIONS

Digital devices, such as desktop PC, laptop and digital video cameras

AXN(1/3/4)

ORDERING INFORMATION

1. P8 (11.5 mm)

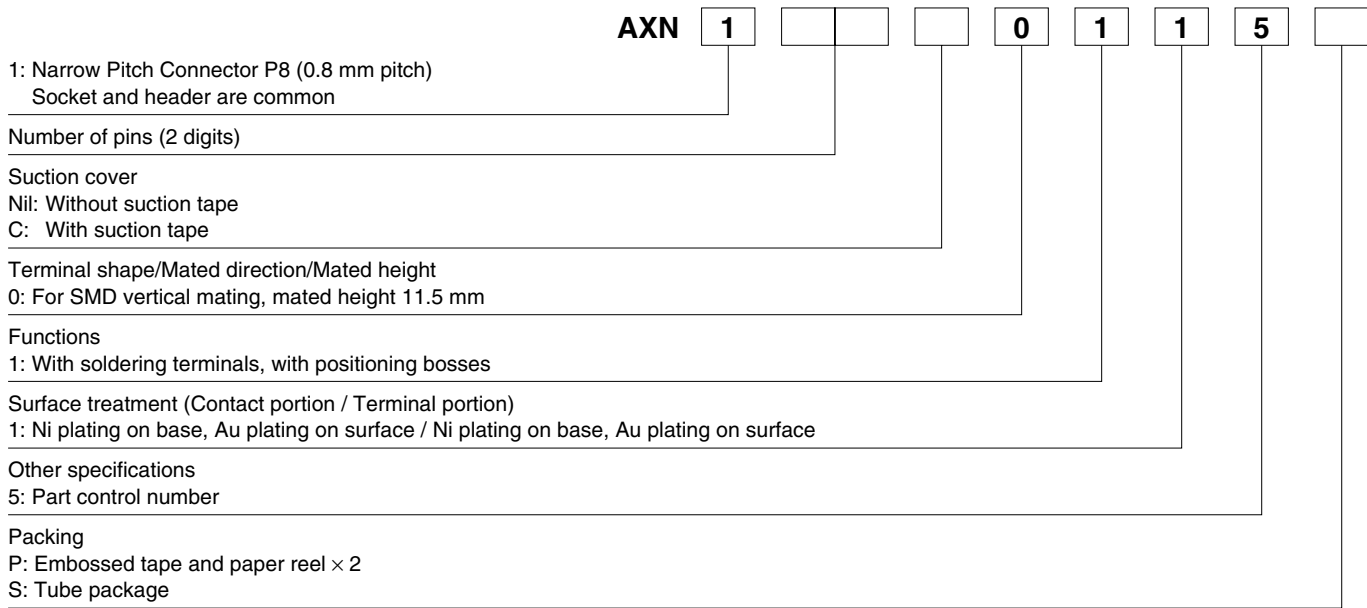

2. P8 (3.0 mm, 3.5 mm, 4.0 mm, 4.5 mm, 5.0 mm, 5.5 mm, 6.0 mm, 7.0 mm, 8.0 mm, 13.0 mm, 14.0 mm)

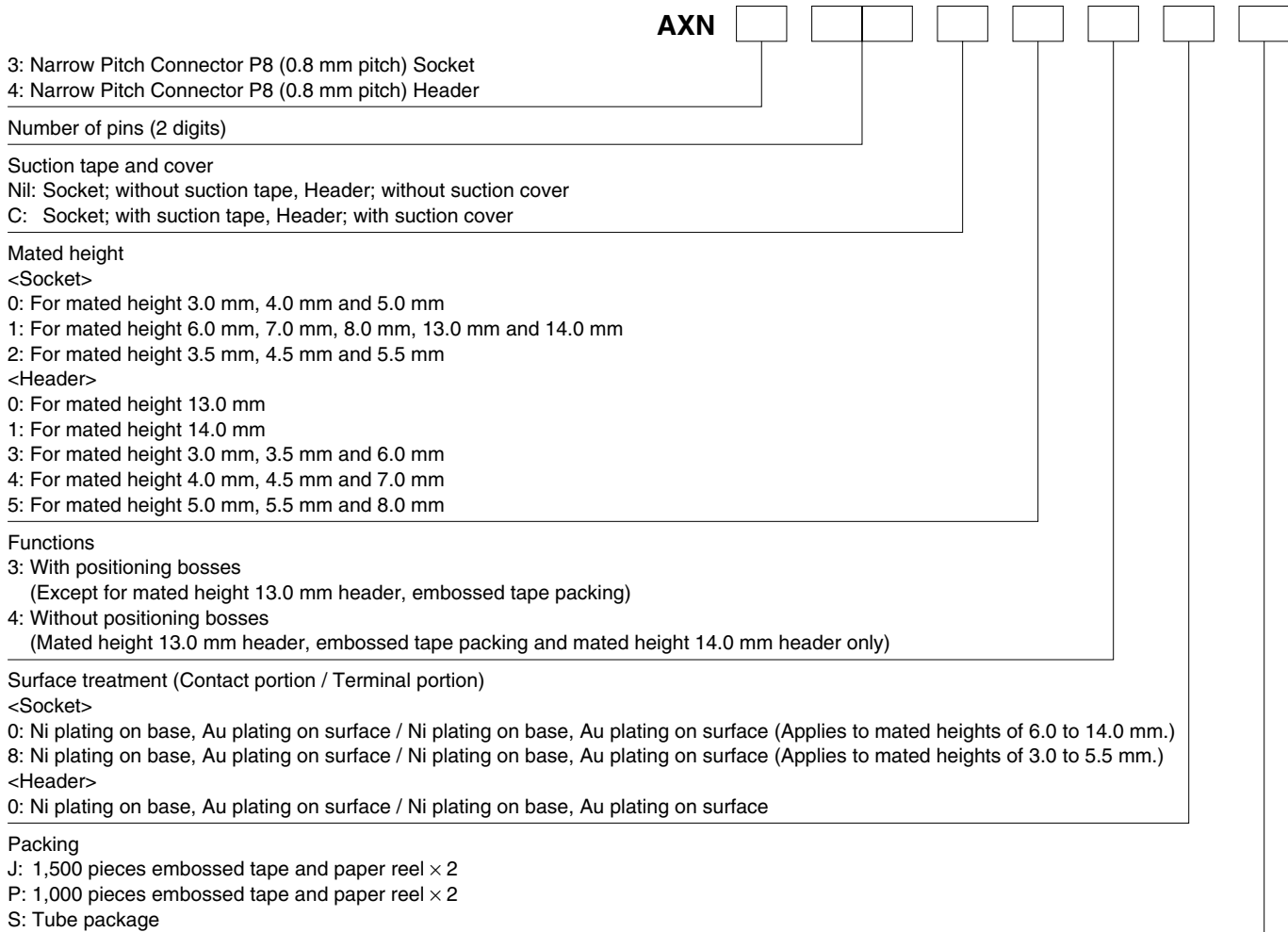

Notes: 1. The tape width for 100-pin embossed tape packaging is non-JIS standard. Please inquire.
2. The depth of the embossed tape for headers with 13 mm and 14 mm mated heights is non-JIS standard. Please test with your mounter before using.
3. Models possible for "J" packaging are as follows:
Socket mated heights: 3.0 mm, 3.5 mm, 4.0 mm, 4.5 mm, 5.0 mm, and 5.5 mm
Headers: Mated heights 3.0 mm, 3.5 mm, and 6.0 mm

PRODUCT TYPES

Mated height	No. of pins	Stick package				Embossed tape package					
		Part No.		Packing quantity		Part No.		Packing quantity			
		Socket	Header	Stick	Outer carton	Socket	Header	Inner carton (1 reel)	Outer carton		
3.0 mm	16	AXN316038S	AXN416330S	50 pcs.	300 pcs.	AXN316038*	AXN416330*				
	20	AXN320038S	AXN420330S	50 pcs.	300 pcs.	AXN320038*	AXN420330*				
	24	AXN324038S	AXN424330S	30 pcs.	300 pcs.	AXN324038*	AXN424330*				
	26	AXN326038S	AXN426330S	30 pcs.	300 pcs.	AXN326038*	AXN426330*				
	30	AXN330038S	AXN430330S	30 pcs.	300 pcs.	AXN330038*	AXN430330*				
	40	AXN340038S	AXN440330S	25 pcs.	300 pcs.	AXN340038*	AXN440330*				
	50	AXN350038S	AXN450330S	20 pcs.	300 pcs.	AXN350038*	AXN450330*				
	60	AXN360038S	AXN460330S	15 pcs.	300 pcs.	AXN360038*	AXN460330*				
	80	AXN380038S	AXN480330S	12 pcs.	300 pcs.	AXN380038*	AXN480330*				
100	AXN300038S	AXN400330S	12 pcs.	300 pcs.	—	—					
3.5 mm	16	AXN316238S	AXN416330S	50 pcs.	300 pcs.	AXN316238*	AXN416330*				
	24	AXN324238S	AXN424330S	30 pcs.	300 pcs.	AXN324238*	AXN424330*				
	26	AXN326238S	AXN426330S	30 pcs.	300 pcs.	AXN326238*	AXN426330*				
	30	AXN330238S	AXN430330S	30 pcs.	300 pcs.	AXN330238*	AXN430330*				
	60	AXN360238S	AXN460330S	15 pcs.	300 pcs.	AXN360238*	AXN460330*				
4.0 mm	16	AXN316038S	AXN416430S	50 pcs.	300 pcs.	AXN316038*	AXN416430P				
	20	AXN320038S	AXN420430S	50 pcs.	300 pcs.	AXN320038*	AXN420430P				
	26	AXN326038S	AXN426430S	30 pcs.	300 pcs.	AXN326038*	AXN426430P				
	30	AXN330038S	AXN430430S	30 pcs.	300 pcs.	AXN330038*	AXN430430P				
	40	AXN340038S	AXN440430S	25 pcs.	300 pcs.	AXN340038*	AXN440430P				
	50	AXN350038S	AXN450430S	20 pcs.	300 pcs.	AXN350038*	AXN450430P				
	60	AXN360038S	AXN460430S	15 pcs.	300 pcs.	AXN360038*	AXN460430P				
	80	AXN380038S	AXN480430S	12 pcs.	300 pcs.	AXN380038*	AXN480430P				
100	AXN300038S	AXN400430S	12 pcs.	300 pcs.	—	—					
4.5 mm	16	AXN316238S	AXN416430S	50 pcs.	300 pcs.	AXN316238*	AXN416430P				
	26	AXN326238S	AXN426430S	30 pcs.	300 pcs.	AXN326238*	AXN426430P				
	30	AXN330238S	AXN430430S	30 pcs.	300 pcs.	AXN330238*	AXN430430P				
	60	AXN360238S	AXN460430S	15 pcs.	300 pcs.	AXN360238*	AXN460430P				
5.0 mm	12	AXN312038S	AXN412530S	50 pcs.	300 pcs.	AXN312038*	AXN412530P			Note 1) "Asterisk" mark on end of part No.; J: 1,500 pieces (recommendation) P: 1,000 pieces	Note 1) "Asterisk" mark on end of part No.; J: 3,000 pieces (recommendation) P: 2,000 pieces
	14	AXN314038S	AXN414530S	50 pcs.	300 pcs.	AXN314038*	AXN414530P				
	20	AXN320038S	AXN420530S	50 pcs.	300 pcs.	AXN320038*	AXN420530P				
	24	AXN324038S	AXN424530S	30 pcs.	300 pcs.	AXN324038*	AXN424530P				
	26	AXN326038S	AXN426530S	30 pcs.	300 pcs.	AXN326038*	AXN426530P				
	30	AXN330038S	AXN430530S	30 pcs.	300 pcs.	AXN330038*	AXN430530P				
	40	AXN340038S	AXN440530S	25 pcs.	300 pcs.	AXN340038*	AXN440530P				
	50	AXN350038S	AXN450530S	20 pcs.	300 pcs.	AXN350038*	AXN450530P				
	60	AXN360038S	AXN460530S	15 pcs.	300 pcs.	AXN360038*	AXN460530P				
80	AXN380038S	AXN480530S	12 pcs.	300 pcs.	AXN380038*	AXN480530P					
100	AXN300038S	AXN400530S	12 pcs.	300 pcs.	—	—					
5.5 mm	12	AXN312238S	AXN412530S	50 pcs.	300 pcs.	AXN312238*	AXN412530P				
	24	AXN324238S	AXN424530S	30 pcs.	300 pcs.	AXN324238*	AXN424530P				
	26	AXN326238S	AXN426530S	30 pcs.	300 pcs.	AXN326238*	AXN426530P				
	30	AXN330238S	AXN430530S	30 pcs.	300 pcs.	AXN330238*	AXN430530P				
	60	AXN360238S	AXN460530S	15 pcs.	300 pcs.	AXN360238*	AXN460530P				
6.0 mm	20	AXN320130S	AXN420330S	50 pcs.	300 pcs.	AXN320130P	AXN420330*				
	24	AXN324130S	AXN424330S	30 pcs.	300 pcs.	AXN324130P	AXN424330*				
	26	AXN326130S	AXN426330S	30 pcs.	300 pcs.	AXN326130P	AXN426330*				
	30	AXN330130S	AXN430330S	30 pcs.	300 pcs.	AXN330130P	AXN430330*				
	40	AXN340130S	AXN440330S	25 pcs.	300 pcs.	AXN340130P	AXN440330*				
	50	AXN350130S	AXN450330S	20 pcs.	300 pcs.	AXN350130P	AXN450330*				
	60	AXN360130S	AXN460330S	15 pcs.	300 pcs.	AXN360130P	AXN460330*				
	64	AXN364130S	AXN464330S	15 pcs.	300 pcs.	AXN364130P	AXN464330*				
	80	AXN380130S	AXN480330S	12 pcs.	300 pcs.	AXN380130P	AXN480330*				
100	AXN300130S	AXN400330S	12 pcs.	300 pcs.	—	—					
7.0 mm	20	AXN320130S	AXN420430S	50 pcs.	300 pcs.	AXN320130P	AXN420430P				
	22	AXN322130S	AXN422430S	30 pcs.	300 pcs.	AXN322130P	AXN422430P				
	26	AXN326130S	AXN426430S	30 pcs.	300 pcs.	AXN326130P	AXN426430P				
	30	AXN330130S	AXN430430S	30 pcs.	300 pcs.	AXN330130P	AXN430430P				
	40	AXN340130S	AXN440430S	25 pcs.	300 pcs.	AXN340130P	AXN440430P				
	50	AXN350130S	AXN450430S	20 pcs.	300 pcs.	AXN350130P	AXN450430P				
	60	AXN360130S	AXN460430S	15 pcs.	300 pcs.	AXN360130P	AXN460430P				
	80	AXN380130S	AXN480430S	12 pcs.	300 pcs.	AXN380130P	AXN480430P				
100	AXN300130S	AXN400430S	12 pcs.	300 pcs.	—	—					

AXN(1/3/4)

Mated height	No. of pins	Stick package				Embossed tape package			
		Part No.		Packing quantity		Part No.		Packing quantity	
		Socket	Header	Stick	Outer carton	Socket	Header	Inner carton (1 reel)	Outer carton
8.0 mm	20	AXN320130S	AXN420530S	50 pcs.	300 pcs.	AXN320130P	AXN420530P	1,000 pcs.	2,000 pcs.
	22	AXN322130S	AXN422530S	30 pcs.	300 pcs.	AXN322130P	AXN422530P		
	24	AXN324130S	AXN424530S	30 pcs.	300 pcs.	AXN324130P	AXN424530P		
	26	AXN326130S	AXN426530S	30 pcs.	300 pcs.	AXN326130P	AXN426530P		
	30	AXN330130S	AXN430530S	30 pcs.	300 pcs.	AXN330130P	AXN430530P		
	34	AXN334130S	AXN434530S	30 pcs.	300 pcs.	AXN334130P	AXN434530P		
	40	AXN340130S	AXN440530S	25 pcs.	300 pcs.	AXN340130P	AXN440530P		
	50	AXN350130S	AXN450530S	20 pcs.	300 pcs.	AXN350130P	AXN450530P		
	60	AXN360130S	AXN460530S	15 pcs.	300 pcs.	AXN360130P	AXN460530P		
	80	AXN380130S	AXN480530S	12 pcs.	300 pcs.	AXN380130P	AXN480530P		
	100	AXN300130S	AXN400530S	12 pcs.	300 pcs.	—	—	—	—
11.5 mm	30	AXN1300115S (Socket, Header)		30 pcs.	300 pcs.	AXN1300115P (Socket, Header)		350 pcs.	700 pcs.
	40	AXN1400115S (Socket, Header)		25 pcs.	300 pcs.	AXN1400115P (Socket, Header)		350 pcs.	700 pcs.
	50	AXN1500115S (Socket, Header)		20 pcs.	300 pcs.	AXN1500115P (Socket, Header)		350 pcs.	700 pcs.
	80	AXN1800115S (Socket, Header)		12 pcs.	300 pcs.	AXN1800115P (Socket, Header)		250 pcs.	500 pcs.
	100	AXN1000115S (Socket, Header)		12 pcs.	300 pcs.	—		—	—
13.0 mm	20	AXN320130S	AXN420030S	50 pcs.	300 pcs.	AXN320130P	AXN420040P ^{Note 6)}	Socket: 1,000 pcs. Header: 500 pcs.	Socket: 2,000 pcs. Header: 1,000 pcs.
	30	AXN330130S	AXN430030S	30 pcs.	300 pcs.	AXN330130P	AXN430040P ^{Note 6)}		
	40	AXN340130S	AXN440030S	25 pcs.	300 pcs.	AXN340130P	AXN440040P ^{Note 6)}		
	50	AXN350130S	AXN450030S	20 pcs.	300 pcs.	AXN350130P	AXN450040P ^{Note 6)}		
	60	AXN360130S	AXN460030S	15 pcs.	300 pcs.	AXN360130P	AXN460040P ^{Note 6)}		
	80	AXN380130S	AXN480030S	12 pcs.	300 pcs.	AXN380130P	AXN480040P ^{Note 6)}		
14.0 mm	20	AXN320130S	AXN420130S	50 pcs.	300 pcs.	AXN320130P	AXN420130P	Socket: 1,000 pcs. Header: 400 pcs.	Socket: 2,000 pcs. Header: 800 pcs.

Notes: 1. Please add following suffix at * marked positions.

J: Inner carton (1 reel) 1,500 pcs. (Outer carton: 3,000 pcs.)

P: Inner carton (1 reel) 1,000 pcs. (Outer carton: 2,000 pcs.)

In order to reduce the amount of packaging materials used to help protect the global environment, it is recommended that each packaging box contains 1,500 units with the "J" product number suffix.

As for the part No. P is suffixed, only 1,000 pcs. reel is available.

2. Regarding ordering units: During production: Please make orders in 1-reel units.

Samples for mounting confirmation: Available in units of 50 pieces. Please contact our sales office.

Samples: Small lot orders are possible. Change the suffix "J" to the suffix "P"

3. Connectors with suction tape and suction cover are also available. Socket: Suction tape, Header: Suction cover. For this type of connector, insert the letter "C" between the 6th and 7th column of the ordering number.

Example: For a 20 pin contact socket with 3mm mated height (embossed tape package): AXN320C038P

4. The standard type comes with positioning bosses. Connectors without positioning bosses are available for on-demand production (3,000 pcs./lot or more). Please inquire.

5. Since the embossed tape width of 100 pin contact connectors packaged with embossed tape exceeds the JIS standard, please consult us.

6. Headers that have 13.0 mm mated height and embossed tape packaging do not come with positioning bosses.

The depth of the embossed tape for headers with 13.0 mm and 14.0 mm mated heights is non-JIS compliant. Please test with your mounter before using.

SPECIFICATIONS

1. Characteristics

Item		Specifications		Conditions		
		3mm, 3.5mm, 4mm, 4.5mm, 5.0mm, 5.5mm, 6.0mm, 7.0mm, 8.0mm, 13.0mm, 14.0mm type	11.5mm type			
Electrical characteristics	Rated current	0.5A				
	Rated voltage	60V AC/DC				
	Breakdown voltage	250V AC for 1 minute		Detection current: 1mA		
	Insulation resistance	Min. 1,000MΩ		Using 500V DC megger		
	Contact resistance	Max. 60mΩ	Max. 50mΩ	Based on the contact resistance measurement method specified by JIS C 5402.		
Mechanical characteristics	Composite insertion force	Max. 43.1N (30 pin contacts)	Max. 0.785N × no. of pins (initial)			
	Composite removal force	Min. 6.37N (30 pin contacts)	Min. 0.127N × no. of pins			
	Contact holding force	40 pin contacts or less: Min. 1.96N 50 pin contacts or more: Min. 0.981N	Min. 1.96N	Measuring the maximum force. As the contact is axially pull out.		
Environmental characteristics	Ambient temperature	-55°C to +85°C		No freezing at low temperatures		
	Soldering heat resistance	Max. peak temperature of 245°C (on the surface of the PC board around the connector terminals)		Infrared reflow soldering		
		300°C within 5 seconds		Soldering iron		
	Storage temperature	-55°C to +85°C (product only) -40°C to +50°C (standard packing)		No freezing at low temperatures. No dew condensation.		
	Thermal shock resistance (header and socket mated)	5 cycles, insulation resistance min. 100MΩ, contact resistance max. 60mΩ	5 cycles, insulation resistance min. 100MΩ, contact resistance max. 50mΩ	Conformed to MIL-STD-202F, method 107G		
				Order	Temperature (°C)	Time (minutes)
				1	-55 ₋₃ ⁰	30
				2	∫	Max. 5
			3	85 ₋₃ ³	30	
			4	∫	Max. 5	
			-55 ₋₃ ⁰			
Humidity resistance (header and socket mated)	120 hours, insulation resistance min. 100MΩ, contact resistance max. 60mΩ	240 hours, insulation resistance min. 100MΩ, contact resistance max. 50mΩ	Bath temperature 40±2°C, humidity 90 to 95% R.H.			
Saltwater spray resistance (header and socket mated)	24 hours, insulation resistance min. 100MΩ, contact resistance max. 60mΩ	48 hours, insulation resistance min. 100MΩ, contact resistance max. 50mΩ	Bath temperature 35±2°C, saltwater concentration 5±1%			
H ₂ S resistance (header and socket mated)	48 hours, contact resistance max. 60mΩ	96 hours, contact resistance max. 50mΩ	Bath temperature 40±2°C, gas concentration 3±1 ppm, humidity 75 to 80% R.H.			
SO ₂ resistance (header and socket mated)	48 hours, contact resistance max. 60mΩ	96 hours, contact resistance max. 50mΩ	Bath temperature 40±2°C, gas concentration 10±3 ppm, humidity 90 to 95% R.H.			
Lifetime characteristics	Insertion and removal life	50 times	100 times	Repeated insertion and removal speed of max. 200 times/hours		
Unit weight	Mated height 3mm 30 pin contacts; Socket: 0.26g Header: 0.26g 50 pin contacts; Socket: 0.40g Header: 0.44g					

2. Material and surface treatment

Part name	3.0mm, 3.5mm, 4.0mm, 4.5mm, 5.0mm, 5.5mm, 6.0mm, 7.0mm, 8.0mm, 13.0mm, 14.0mm type		11.5mm type	
	Material	Surface treatment	Material	Surface treatment
Molded portion	Heat-resistant resin (UL94V-0)	—	LCP resin (UL94V-0)	—
Bracket	—	—	Copper alloy	Cu plating on base, Sn plating on surface
Contact	Copper alloy	Contact portion: Ni plating on base, Au plating on surface Terminal portion: Ni plating on base, Au plating on surface (Except for thick of terminal)	Copper alloy	Contact portion: Ni plating on base, Au plating on surface Terminal portion: Ni plating on base, Au plating on surface (Except for thick of terminal)

AXN(1/3/4)

DIMENSIONS (Unit: mm)

The CAD data of the products with a **CAD Data** mark can be downloaded from: <http://industrial.panasonic.com/ac/e/>

• Mated height 3.0mm, 4.0mm, 4.5mm, 5.0mm, 5.5mm, 6.0mm, 7.0mm, 8.0mm, 13.0mm, 14.0mm type

1) Socket

CAD Data

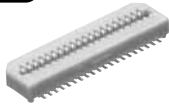

Dimension table (mm)

No. of pins	A	B	C	D	E	F
12	7.40	4.00	6.30	6.30	4.00	0.10
14	8.20	4.80	7.10	7.10	4.80	
16	9.00	5.60	7.90	7.90	5.60	
20	10.60	7.20	9.50	9.50	7.20	
22	11.40	8.00	10.30	10.30	8.00	
24	12.20	8.80	11.10	11.10	8.80	
26	13.00	9.60	11.90	11.90	9.60	0.15
30	14.60	11.20	13.50	13.50	11.20	
34	16.20	12.80	15.10	15.10	12.80	
40	18.60	15.20	17.50	17.50	15.20	
50	23.40	19.20	21.50	21.50	19.20	
60	27.40	23.20	25.50	25.50	23.20	
64	29.00	24.80	27.10	27.10	24.80	
80	35.40	31.20	33.50	33.50	31.20	
100	43.40	39.20	41.50	41.50	39.20	

Mated height	G
3.0mm, 4.0mm, 5.0mm common	2.20
3.5mm, 4.5mm, 5.5mm common	2.70
6.0mm, 7.0mm, 8.0mm, 13.0mm, 14.0mm common	5.20

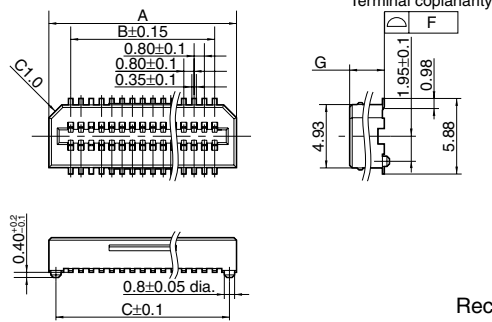

General tolerance: ±0.3

Recommended PC board pattern (TOP VIEW)

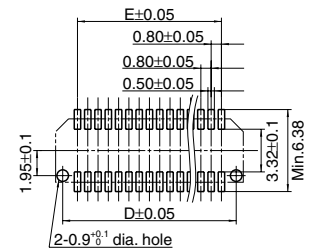

2) Header

CAD Data

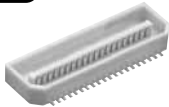

Dimension table (mm)

No. of pins	A	B	C	D	E	F
12	8.45	4.00	6.30	6.30	4.00	0.10
14	9.25	4.80	7.10	7.10	4.80	
16	10.05	5.60	7.90	7.90	5.60	
20	11.65	7.20	9.50	9.50	7.20	
22	12.45	8.00	10.30	10.30	8.00	
24	13.25	8.80	11.10	11.10	8.80	
26	14.05	9.60	11.90	11.90	9.60	Note) 0.15
30	15.65	11.20	13.50	13.50	11.20	
34	17.25	12.80	15.10	15.10	12.80	
40	19.65	15.20	17.50	17.50	15.20	
50	25.85	19.20	21.50	21.50	19.20	
60	29.85	23.20	25.50	25.50	23.20	
64	31.45	24.80	27.10	27.10	24.80	
80	37.85	31.20	33.50	33.50	31.20	
100	45.85	39.20	41.50	41.50	39.20	

Note: The 13 mm mated height (20 to 80 pin contacts) terminal flatness is 0.1 mm.

Mated height	G
3.0mm, 3.5mm, 6.0mm common	2.72
4.0mm, 4.5mm, 7.0mm common	3.72
5.0mm, 5.5mm, 8.0mm common	4.72
13.0mm	10.14
14.0mm	11.14

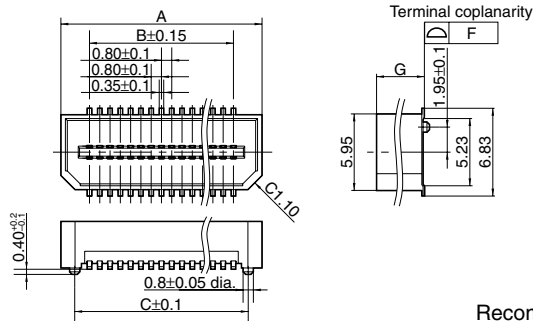

General tolerance: ±0.3

Recommended PC board pattern (TOP VIEW)

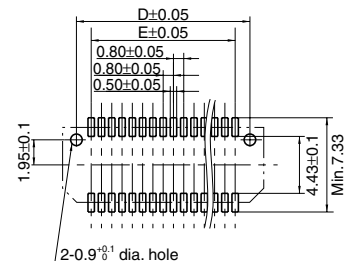

3) Socket and header are mated

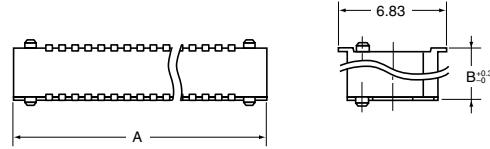
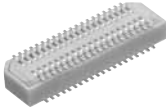

Dimension table (mm)

No. of pins	A	Mated height	B
12	8.45	3.0mm	3.00
14	9.25	3.5mm	3.50
16	10.05	4.0mm	4.00
20	11.65	4.5mm	4.50
22	12.45	5.0mm	5.00
24	13.25	5.5mm	5.50
26	14.05	6.0mm	6.00
30	15.65	7.0mm	7.00
34	17.25	8.0mm	8.00
40	19.65	13.0mm	13.00
50	25.85	14.0mm	14.00
60	29.85		
64	31.45		
80	37.85		
100	45.85		

Note: Common for all mated heights.

- Mated height 11.5mm type (Socket and Header)
(30 pin contacts, 40 pin contacts, 50 pin contacts)

CAD Data

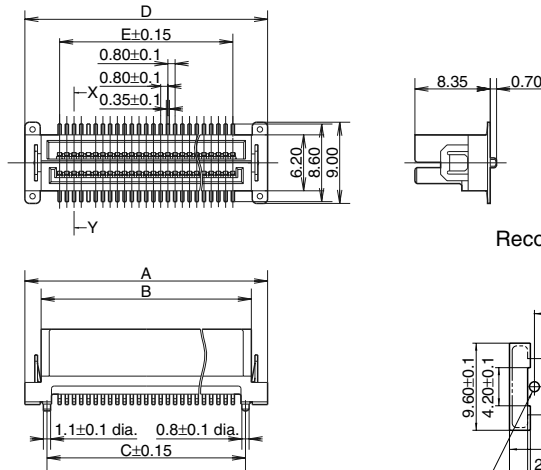
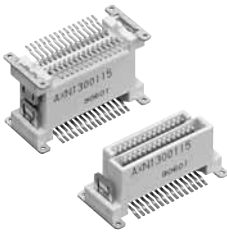

Recommended PC board pattern (TOP VIEW)

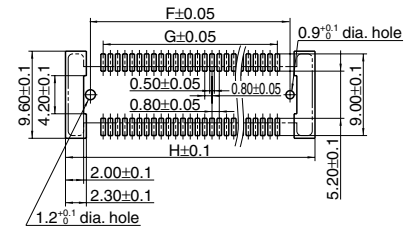

General tolerance: ±0.3

Dimension table (mm)

No. of pins	A	B	C	D	E	F	G	H
30	18.90	15.30	14.00	18.90	11.20	14.00	11.20	19.50
40	22.90	19.30	18.00	22.90	15.20	18.00	15.20	23.50
50	26.90	23.30	22.00	26.90	19.20	22.00	19.20	27.50

X-Y cross section

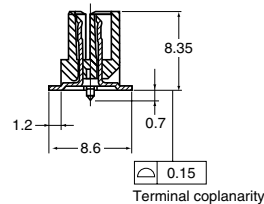

Stacking mated diagram

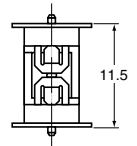

AXN(1/3/4)

- Mated height 11.5mm type (Socket and Header)
(80 pin contacts, 100 pin contacts)

CAD Data

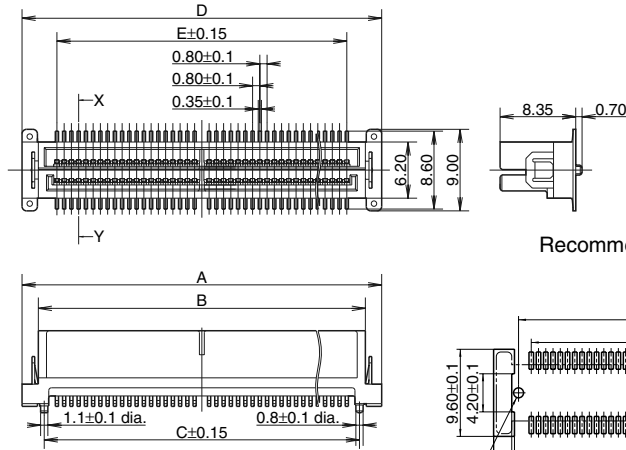
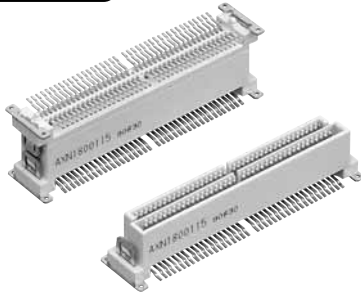

General tolerance: ± 0.3

Recommended PC board pattern
(TOP VIEW)

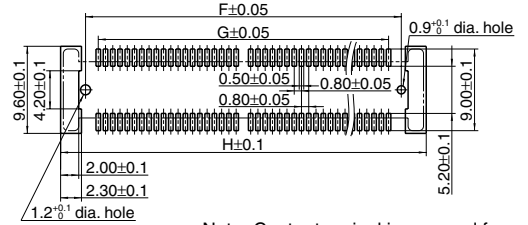

Note: Center terminal is removed for
80 and 100 pin contact type

Dimension table (mm)

No. of pins	A	B	C	D	E	F	G	H
80	39.70	36.10	34.80	39.70	32.00	34.80	32.00	40.30
100	47.70	44.10	42.80	47.70	40.00	42.80	40.00	48.30

X-Y cross section

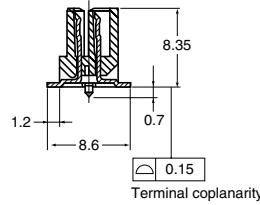

Stacking mated diagram

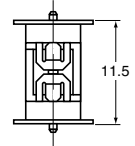

EMBOSSED TAPE DIMENSIONS

(unit: mm, Common for respective contact type, socket and header)

- Tape dimensions (Conforming to JIS C 0806:1990.

However, some tapes have mounting hole pitches that do not comply with the standard.)

- Paper reel dimensions (Conforming to JIS C 0806-1990)

Tape I

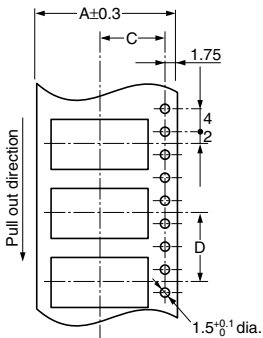

Tape II

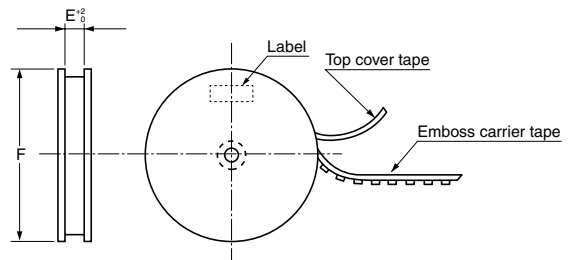
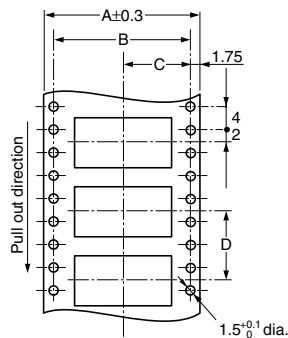

Dimension table (mm)

(1) Suffix: J (1 reel, 1,500 pieces embossed tape package)

Mated height	No. of pins	Type of taping	A	B	C	D	E	F	Quantity per reel
Socket: 3.0mm, 3.5mm, 4.0mm, 4.5mm, 5.0mm, 5.5mm Header: 3.0mm, 3.5mm, 6.0mm	12 to 32	Tape I	24.00	—	11.50	12.00	24.40	370 dia.	1,500 pcs.
	34 to 40	Tape II	32.00	28.40	14.20	12.00	32.40	370 dia.	
	50 to 60	Tape II	44.00	40.40	20.20	12.00	44.40	370 dia.	
	80	Tape II	56.00	52.40	26.20	12.00	56.40	370 dia.	

(2) Suffix: P (1 reel, 1,000, 500, 350 and 250 pieces embossed tape package)

Mated height	No. of pins	Type of taping	A	B	C	D	E	F	Quantity per reel
Socket: 3.0mm, 3.5mm, 4.0mm, 4.5mm, 5.0mm, 5.5mm Header: 3.0mm, 3.5mm, 4.0mm, 4.5mm, 6.0mm, 7.0mm	12 to 32	Tape I	24.00	—	11.50	12.00	24.40	330 dia.	1,000 pcs.
	34 to 40	Tape II	32.00	28.40	14.20	12.00	32.40	330 dia.	
	50 to 60	Tape II	44.00	40.40	20.20	12.00	44.40	330 dia.	
	80	Tape II	56.00	52.40	26.20	12.00	56.40	330 dia.	
Socket: 6.0mm, 7.0mm, 8.0mm, 13.0mm, 14.0mm Header: 5.0mm, 5.5mm, 8.0mm	16 to 32	Tape I	24.00	—	11.50	12.00	24.40	370 dia.	1,000 pcs.
	34 to 40	Tape II	32.00	28.40	14.20	12.00	32.40	370 dia.	
	50 to 60	Tape II	44.00	40.40	20.20	12.00	44.40	370 dia.	
	80	Tape II	56.00	52.40	26.20	12.00	56.40	370 dia.	
11.5mm	30 to 40	Tape II	32.00	28.40	14.20	24.00	32.40	370 dia.	350 pcs.
	50	Tape II	44.00	40.40	20.20	24.00	44.40	370 dia.	350 pcs.
	80	Tape II	56.00	52.40	26.20	24.00	56.40	370 dia.	250 pcs.
Header: 13.0mm	20	Tape I	24.00	—	11.50	16.00	24.40	370 dia.	500 pcs.
	30	Tape I	24.00	—	11.50	16.00	24.40	370 dia.	500 pcs.
	40	Tape II	32.00	28.40	14.20	16.00	32.40	370 dia.	500 pcs.
	50	Tape II	44.00	40.40	20.20	16.00	44.40	370 dia.	500 pcs.
	60	Tape II	44.00	40.40	20.20	16.00	44.40	370 dia.	500 pcs.
	80	Tape II	56.00	52.40	26.20	16.00	56.40	370 dia.	500 pcs.
Header: 14.0mm	20	Tape I	24.00	—	11.50	16.00	24.40	370 dia.	400 pcs.

Connector orientation with respect to direction of progress of embossed tape

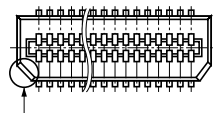
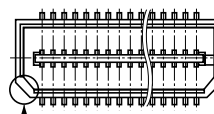
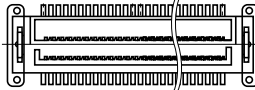
Direction of tape progress	Type	Mated height: 3.0mm, 3.5mm, 4.0mm, 4.5mm, 5.0mm, 5.5mm, 6.0mm, 7.0mm, 8.0mm, 13.0mm	Mated height 11.5mm
	↓	<p>Socket</p>  <p>This corner is oriented on the C side.</p> <p>Header</p>  <p>This corner is oriented on the C side.</p>	<p>Socket and header are common</p> 

NOTES

Note that types having a mated height of 11.5mm cannot be mated with products having other mated heights even though the shape of their socket headers is the same as the rated shape (position of the positioning boss and arrangement of mounting pads) is different.

Please refer to the latest product specifications when designing your product.

Notes on Using Narrow pitch Connectors

Regarding the design of devices and PC board patterns

1) When connecting several connectors together by stacking, make sure to maintain proper accuracy in the design of structure and mounting equipment so that the connectors are not subjected to twisting and torsional forces.

2) With mounting equipment, there may be up to a ± 0.2 to 0.3 -mm error in positioning. Be sure to design PC boards and patterns while taking into consideration the performance and abilities of the required equipment.

3) Some connectors have tabs embossed on the body to aid in positioning. When using these connectors, make sure that the PC board is designed with positioning holes to match these tabs.

4) To ensure the required mechanical strength when soldering the connector terminals, make sure the PC board meets recommended PC board pattern design dimensions given.

5) For all connectors of the narrow pitch series, to prevent the PC board from coming off during vibrations or impacts, and to prevent loads from falling directly on the soldered portions, be sure to design some means to fix the PC board in place.

Example) Secure in place with screws

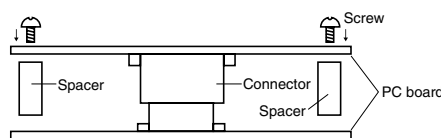

When connecting PC boards, take appropriate measures to prevent the connector from coming off.

6) Notes when using a FPC.

(1) When the connector is soldered to an FPC board, during its insertion and removal procedures, forces may be applied to the terminals and cause the soldering to come off. It is recommended to use a reinforcement board on the

backside of the FPC board to which the connector is being connected. Please make the reinforcement board dimensions bigger than the outer limits of the recommended PC board pattern (should be approximately 1 mm greater than the outer limit).

Material should be glass epoxy or polyimide, and the thickness should be between 0.2 and 0.3 mm.

(2) Collisions, impacts, or turning of FPC boards, may apply forces on the connector and cause it to come loose. Therefore, make to design retaining plates or screws that will fix the connector in place.

7) The narrow pitch connector series is designed to be compact and thin.

Although ease of handling has been taken into account, take care when mating the connectors, as displacement or angled mating could damage or deform the connector.

Regarding the selection of the connector placement machine and the mounting procedures

1) Select the placement machine taking into consideration the connector height, required positioning accuracy, and packaging conditions.

2) Be aware that if the catching force of the placement machine is too great, it may deform the shape of the connector body or connector terminals.

3) Be aware that during mounting, external forces may be applied to the connector contact surfaces and terminals and cause deformations.

4) Depending on the size of the connector being used, self alignment may not be possible. In such cases, be sure to carefully position the terminal with the PC board pattern.

5) The positioning bosses give an approximate alignment for positioning on the PC board. For accurate positioning of the connector when mounting it to the PC board, we recommend using an automatic positioning machine.

6) Excessive moulder chucking force may deform the molded or metal part of the connector. Consult us in advance if chucking is to be applied.

Notes on Using Narrow pitch Connectors

Regarding soldering

1. Reflow soldering

1) Measure the recommended profile temperature for reflow soldering by placing a sensor on the PC board near the connector surface or terminals. (The setting for the sensor will differ depending on the sensor used, so be sure to carefully read the instructions that comes with it.)

2) As for cream solder printing, screen printing is recommended.

3) To determine the relationship between the screen opening area and the PC-board foot pattern area, refer to the diagrams in the recommended patterns for PC boards and metal masks. Make sure to use the terminal tip as a reference position when setting. Avoid an excessive amount of solder from being applied, otherwise, interference by the solder will cause an imperfect contact.

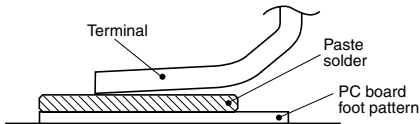

4) Consult us when using a screen-printing thickness other than that recommended.

5) When mounting on both sides of the PC board and the connector is mounting on the underside, use adhesives or other means to ensure the connector is properly fixed to the PC board. (Double reflow soldering on the same side is possible.)

6) N₂ reflow, conducting reflow soldering in a nitrogen atmosphere, increases the solder flow too greatly, enabling wicking to occur. Make sure that the solder feed rate and temperature profile are appropriate.

Soldering conditions

Please use the reflow temperature profile conditions recommended below for reflow soldering. Please contact us before using a temperature profile other than that described below (e.g. lead-free solder).

- Narrow pitch connectors (except P8 type)

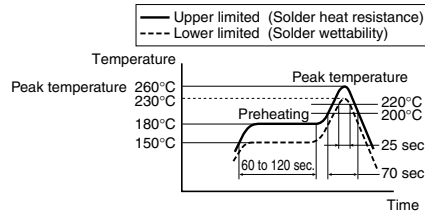

- Narrow pitch connector (P8)

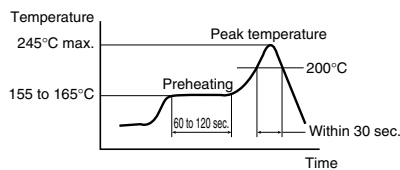

For products other than the ones above, please refer to the latest product specifications.

7) The temperatures are measured at the surface of the PC board near the connector terminals. (The setting for the sensor will differ depending on the sensor used, so be sure to carefully read the instructions that comes with it.)

8) The temperature profiles given in this catalog are values measured when using the connector on a resin-based PC board. When performed reflow soldering on a metal board (iron, aluminum, etc.) or a metal table to mount on a FPC, make sure there is no deformation or discoloration of the connector beforehand and then begin mounting.

9) Consult us when using a screen-printing thickness other than that recommended.

10) Some solder and flux types may cause serious solder or flux creeping. Solder and flux characteristics should be taken into consideration when setting the reflow soldering conditions.

2. Hand soldering

1) Set the soldering iron so that the tip temperature is less than that given in the table below.

Table A

Product name	Soldering iron temperature
SMD type connectors	300°C within 5 sec. 350°C within 3 sec.

2) Do not allow flux to spread onto the connector leads or PC board. This may lead to flux rising up to the connector inside.

3) Touch the soldering iron to the foot pattern. After the foot pattern and connector terminal are heated, apply the solder wire so it melts at the end of the connector terminals.

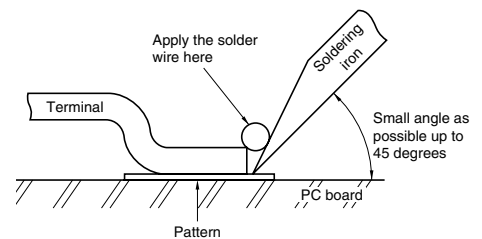

4) Be aware that soldering while applying a load on the connector terminals may cause improper operation of the connector.

5) Thoroughly clean the soldering iron.

6) Flux from the solder wire may get on the contact surfaces during soldering operations. After soldering, carefully check the contact surfaces and clean off any solder before use.

7) For soldering of prototype devices during product development, you can perform soldering at the necessary locations by heating with a hot-air gun by applying cream solder to the foot pattern beforehand. However, at this time, make sure that the air pressure does not move connectors by carefully holding them down with tweezers or other similar tool. Also, be careful not to go too close to the connectors and melt any of the molded components.

8) If an excessive amount of solder is applied during manual soldering, the solder may creep up near the contact points, or solder interference may cause imperfect contact.

3. Solder reworking

1) Finish reworking in one operation.

2) For reworking of the solder bridge, use a soldering iron with a flat tip. To prevent flux from climbing up to the contact surfaces, do not add more flux.

3) Keep the soldering iron tip temperature below the temperature given in Table A.

Handling Single Components

1) Make sure not to drop or allow parts to fall from work bench
2) Excessive force applied to the terminals could cause warping, come out, or weaken the adhesive strength of the solder. Handle with care.
3) Repeated bending of the terminals may cause terminals to break.

4) Do not insert or remove the connector when it is not soldered. Forcibly applied external pressure on the terminals can weaken the adherence of the terminals to the molded part or cause the terminals to lose their evenness.
5) Excessive prying-force applied to one end may cause product breakage and separation of the solder joints at the terminal.

Excessive force applied for insertion in a pivot action as shown may also cause product breakage. Align the header and socket positions before connecting them.

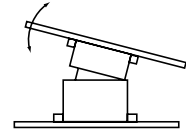

Cleaning flux from PC board

1) To increase the cleanliness of the cleaning fluid and cleaning operations, prepare equipment for cleaning process beginning with boil cleaning, ultrasonic cleaning, and then vapor cleaning.
2) Carefully oversee the cleanliness of the cleaning fluids to make sure that the contact surfaces do not become dirty from the cleaning fluid itself.

3) Since some powerful cleaning solutions may dissolve molded components of the connector and wipe off or discolor printed letters, we recommend aqua pura electronic parts cleaners. Please consult us if you wish to use other types of cleaning fluids.
4) Please note that the surfaces of molded parts may whiten when cleaned with alcohol.

Handling the PC board

• **Handling the PC board after mounting the connector**
When cutting or bending the PC board after mounting the connector, be careful that the soldered sections are subjected to excessive force.

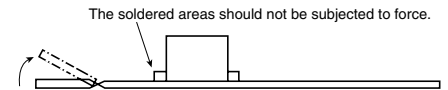

Storage of connectors

1) To prevent problems from voids or air pockets due to heat of reflow soldering, avoid storing the connectors in areas of high humidity. When storing the connectors for more than six months, be sure to consider storage area where the humidity is properly controlled.
2) Depending on the connector type, the color of the connector may vary from connector to connector depending on when it is produced.

Some connectors may change color slightly if subjected to ultraviolet rays during storage. This is normal and will not affect the operation of the connector.
3) When storing the connectors with the PC boards assembled and components already set, be careful not to stack them up so the connectors are subjected to excessive forces.

4) Avoid storing the connectors in locations with excessive dust. The dust may accumulate and cause improper connections at the contact surfaces.

Other Notes

1) These products are made for the design of compact and lightweight devices and therefore the thickness of the molded components has been made very thin. Therefore, be careful during insertion and removal operations for excessive forces applied may damage the products.
2) Dropping of the products or rough mishandling may bend or damage the terminals and possibly hinder proper reflow soldering.

3) Before soldering, try not to insert or remove the connector more than absolutely necessary.
4) When coating the PC board after soldering the connector to prevent the deterioration of insulation, perform the coating in such a way so that the coating does not get on the connector.
5) There may be variations in the colors of products from different production lots. This is normal.

6) The connectors are not meant to be used for switching.
7) Be sure not to allow external pressure to act on connectors when assembling PCBs or moving in block assemblies.

Notes on Using Narrow pitch Connectors

Regarding sample orders to confirm proper mounting

When ordering samples to confirm proper mounting with the placement machine, connectors are delivered in 50-piece units in the condition given right. Consult a sale representative for ordering sample units.

Condition when delivered from manufacturing

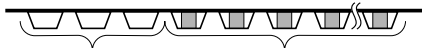

Embossed tape amount required for the mounting

Required number of products for sample production (Unit 50 pcs.)

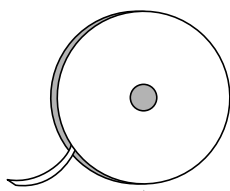

Reel

(Delivery can also be made on a reel by customer request.)

Please refer to the latest product specifications when designing your product.