

Low Ohmic Thick Film Chip Resistors

MCR Series < General Purpose >

●Features

- 1) Very-low ohmic resistance from 47mΩ is in lineup by thick-film resistive element.
- 2) ROHM resistors have obtained ISO9001 / ISO / TS16949 certification.
- 3) "Automotive" product is AEC-Q200 compliant.

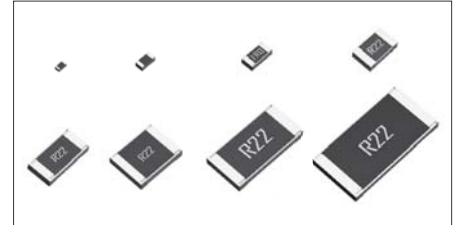

Part No.	Size		Type Code		Packing Specification	Quantity / Reel
	(mm)	(inch)	GENERAL PURPOSE	AUTOMOTIVE *Corresponds to AEC-Q200		
MCR006	0603	0201	YRT	YZP	Paper tape (2mm Pitch)	15,000
MCR01	1005	0402	MRT	MZP		10,000
MCR03	1608	0603	ERT	EZP	Paper tape (4mm Pitch)	5,000
MCR10	2012	0805	EZH			
MCR18	3216	1206	EZH			
MCR25	3225	1210	JZH		Embossed tape (4mm Pitch)	4,000
MCR50	5025	2010	JZH			
MCR100	6432	2512	JZH			

*Please contact us for status of AEC-Q200 on "General purpose" products.

●Part Number Description

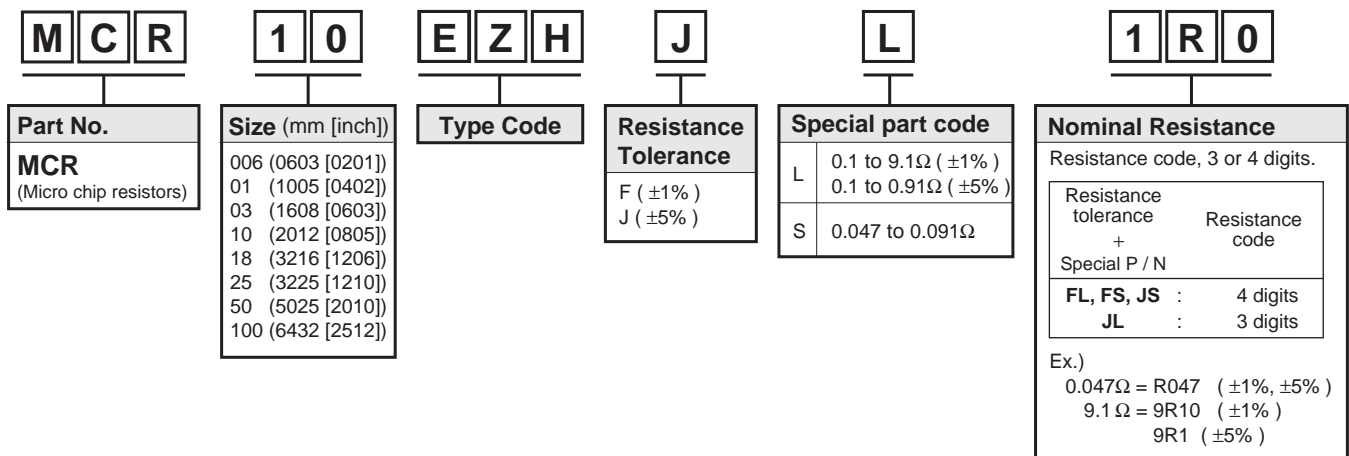

●Products List

Part No.	Type Code	Rated Power (70°C) (W)	Limiting Element Voltage (V)	Maximum Overload Voltage (V)	Temperature Coefficient (ppm / °C)	Resistance Tolerance (%)	Resistance Range	Series	Operating Temperature Range (°C)
MCR006	YRT	0.05	0.67	1.34	±600 / -200	F(±1%)	1.0Ω to 9.1Ω	E24	-55 to +125
MCR01	MRT	0.063	0.76	1.52	±400	F(±1%)	1.0Ω to 9.1Ω		-55 to +155
MCR03	ERT	0.1	0.95	1.90	±400	F(±1%)	1.0Ω to 9.1Ω		
MCR10	EZH	0.25	1.51	3.02	500±300 400±200 ±250	J(±5%)	0.047Ω to 0.091Ω 0.1Ω to 0.13Ω 0.15Ω to 0.91Ω		
					500±300 400±200 ±250	F(±1%)	0.047Ω to 0.091Ω 0.1Ω to 0.13Ω 0.15Ω to 9.1Ω		
MCR18	EZH	0.25	1.51	3.02	500±300 400±200 ±250	J(±5%)	0.047Ω to 0.091Ω 0.1Ω to 0.13Ω 0.15Ω to 0.91Ω		
					500±300 400±200 ±250	F(±1%)	0.047Ω to 0.091Ω 0.1Ω to 0.13Ω 0.15Ω to 9.1Ω		
MCR25	JZH	0.5	2.13	4.26	300±300 ±200	J(±5%)	0.047Ω to 0.091Ω 0.1Ω to 0.91Ω		
					300±300 ±200	F(±1%)	0.047Ω to 0.091Ω 0.1Ω to 9.1Ω		
MCR50	JZH	0.5	2.13	4.26	500±300 400±200 ±250	J(±5%)	0.047Ω to 0.091Ω 0.1Ω to 0.13Ω 0.15Ω to 0.91Ω		
					500±300 400±200 ±250	F(±1%)	0.047Ω to 0.091Ω 0.1Ω to 0.13Ω 0.15Ω to 9.1Ω		
MCR100	JZH	1	3.01	6.02	500±300 400±200 ±250	J(±5%)	0.047Ω to 0.091Ω 0.1Ω to 0.13Ω 0.15Ω to 0.91Ω	-55 to +125	
					500±300 400±200 ±250	F(±1%)	0.047Ω to 0.091Ω 0.1Ω to 0.13Ω 0.15Ω to 9.1Ω		

*Design and specifications are subject to change without notice. Carefully check the specification sheet supplied with the product before using or ordering it.

●Chip Resistor Dimensions and Markings

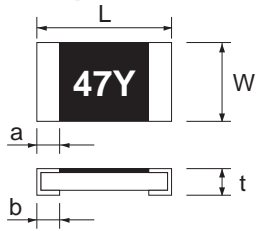

<Marking method>

There are three or four digits used for the calculation number according to IEC code and "R" is used for the decimal point.

(Unit : mm)

Part No.	Type Code	(mm)	(inch)	L	W	t	a	b	Marking existence
MCR006	YRT	0603	0201	0.6±0.03	0.3±0.03	0.23±0.03	0.15±0.05	0.15±0.05	No
MCR01	MRT	1005	0402	1.0±0.05	0.5±0.05	0.35±0.05	0.2±0.1	0.25 ^{+0.05} _{-0.1}	No
MCR03	ERT	1608	0603	1.6±0.1	0.8±0.1	0.45±0.1	0.3±0.2	0.3±0.2	Yes *
MCR10	EZH	2012	0805	2.0±0.1	1.25±0.1	0.55±0.1	0.4±0.2	0.4±0.2	Yes
MCR18	EZH	3216	1206	3.2±0.15	1.6±0.15	0.55±0.1	0.5±0.25	0.5±0.25	Yes
MCR25	JZH	3225	1210	3.2±0.15	2.5±0.15	0.55±0.15	0.5±0.25	0.5±0.25	Yes
MCR50	JZH	5025	2010	5.0±0.15	2.5±0.15	0.55±0.15	0.6±0.25	0.6±0.25	Yes
MCR100	JZH	6432	2512	6.3±0.15	3.2±0.15	0.55±0.15	0.6±0.25	0.6±0.25	Yes

*Marking method of MCR03

The description of markings on the chip resistor are as shown below.

① Marking method :

·For the resistance value contained in E96 series.

The nominal resistance is expressed in 3 digits. The first 2 digits is symbol to the resistance value and the last one is symbol to multipliers.

Example : 100kΩ = 01d (01d→100 × 10³ = 100,000Ω = 100kΩ)

Example : 3.01kΩ = 47b (47b→301 × 10¹ = 3010Ω = 3.01kΩ)

·For the resistance value not contained in E96 series and contained in E-24 series.

The marking is expressed by E-24 series in 3 digits and one short bar under the last marking letter.

Example : 390Ω = 391

Symbol for E96 Series nominal resistance value

Symbol	E96	Symbol	E96	Symbol	E96	Symbol	E96
01	100	25	178	49	316	73	562
02	102	26	182	50	324	74	576
03	105	27	187	51	332	75	590
04	107	28	191	52	340	76	604
05	110	29	196	53	348	77	619
06	113	30	200	54	357	78	634
07	115	31	205	55	365	79	649
08	118	32	210	56	374	80	665
09	121	33	215	57	383	81	681
10	124	34	221	58	392	82	698
11	127	35	226	59	402	83	715
12	130	36	232	60	412	84	732
13	133	37	237	61	422	85	750
14	137	38	243	62	432	86	768
15	140	39	249	63	442	87	787
16	143	40	255	64	453	88	806
17	147	41	261	65	464	89	825
18	150	42	267	66	475	90	845
19	154	43	274	67	487	91	866
20	158	44	280	68	499	92	887
21	162	45	287	69	511	93	909
22	165	46	294	70	523	94	931
23	169	47	301	71	536	95	953
24	174	48	309	72	549	96	976

Symbol for multipliers

Symbol	A	b	C	d	E	F	X	Y
multipliers	10 ⁰	10 ¹	10 ²	10 ³	10 ⁴	10 ⁵	10 ⁻¹	10 ⁻²

●Land pattern Example

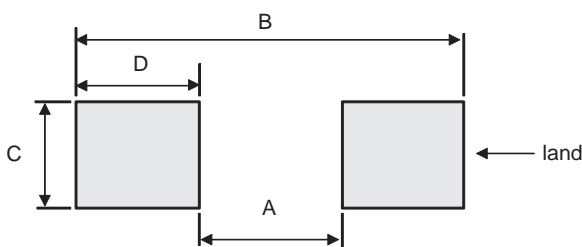

(Unit : mm)

Part No.	Type Code	A	B	C	D
MCR006	YRT	0.3	0.84	0.3	0.27
MCR01	MRT	0.5	1.3	0.5	0.4
MCR03	ERT	1.0	2.0	0.8	0.5
MCR10	EZH	1.2	2.6	1.15	0.7
MCR18	EZH	2.2	4.0	1.5	0.9
MCR25	JZH	2.2	4.0	2.3	0.9
MCR50	JZH	3.8	6.0	2.3	1.1
MCR100	JZH	5.1	8.1	3.0	1.5

●Derating Curve

When the ambient temperature exceeds 70°C, power dissipation must be adjusted according to the derating curves below.

■ MCR006 / 100

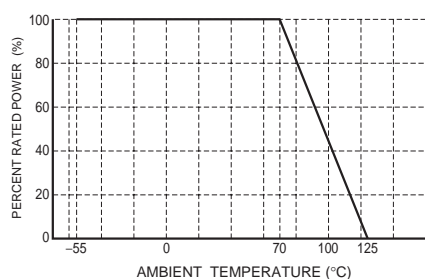

■ MCR01 / 03 / 10 / 18 / 25 / 50

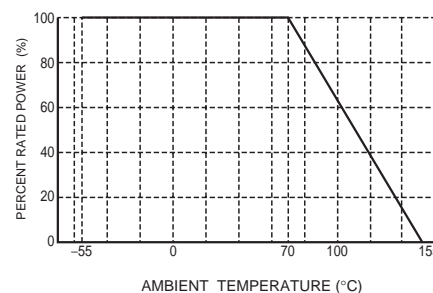

●Characteristics

Test Items	Guaranteed Value	Test Conditions
Resistance	See "Products List"	20°C
Variation of resistance with temperature	See "Products List"	Measurement : +20 / -55 / +20 / +125°C
Overload	± (2.0%+0.005Ω)	Rated voltage (current) ×2.5, 2s. Maximum overload voltage
Solderability	A new uniform coating of minimum of 95% of the surface being immersed and no soldering damage.	Rosin-Ethanol : 25% (weight) Soldering condition : 235±5°C Duration of immersion : 2.0±0.5s
Resistance to soldering heat	± (1.0%+0.005Ω) No remarkable abnormality on the appearance.	Soldering condition : 260±5°C Duration of immersion : 10±1s
Rapid change of temperature	± (1.0%+0.005Ω)	Test temp. -55°C to +125°C 100cycle (MCR006) -55°C to +125°C 5cycle (MCR01 / 03 / 10 / 18 / 25 / 50 / 100)
Damp heat, steady state	± (3.0%+0.005Ω)	40°C, 93%RH (Relative Humidity) Test time : 1,000h to 1,048h
Endurance at 70°C	± (3.0%+0.005Ω)	70°C Rated voltage (current) 1.5h : ON – 0.5h : OFF Test time : 1,000h to 1,048h
Endurance	± (3.0%+0.005Ω)	125°C (MCR006 / 100) 155°C (MCR01 / 03 / 10 / 18 / 25 / 50) Test time : 1,000h to 1,048h
Resistance to solvent	± (1.0%+0.005Ω) ※MCR006 only ± (0.5%+0.005Ω)	23±5°C, Immersion cleaning, 5±0.5min Solvent : 2-propanol
Bend strength of the end face plating	Without Open.	—

Compliance Standard(s) : IEC60115-8
JISC 5201-8

●Chip weight (typical value)

Parameter	Unit	MCR006 YRT	MCR01 MRT	MCR03 ERT	MCR10 EZH	MCR18 EZH	MCR25 JZH	MCR50 JZH	MCR100 JZH
Weight	mg/pc	0.150	0.565	2.03	5.00	9.78	16.5	25.8	42.0

●Tape Dimensions

(Unit : mm)

■ Paper Tape

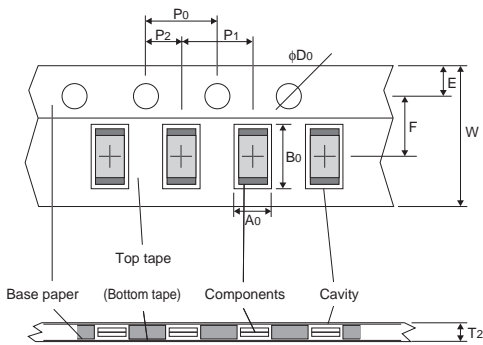

Part No.	Type Code	W	F	E	A ₀	B ₀
MCR006	YRT	8.0±0.2	3.5±0.05	1.75±0.1	0.38±0.03	0.68±0.03
MCR01	MRT	8.0±0.3	3.5±0.05	1.75±0.1	0.7±0.1	1.2±0.1
MCR03	ERT	8.0±0.3	3.5±0.05	1.75±0.1	1.0±0.2	1.8±0.1
MCR10	EZH	8.0±0.3	3.5±0.05	1.75±0.1	1.65 ^{+0.2} _{-0.1}	2.4 ^{+0.2} _{-0.1}
MCR18	EZH	8.0±0.3	3.5±0.05	1.75±0.1	1.95 ^{+0.1} _{-0.05}	3.5 ^{+0.15} _{-0.05}

Part No.	Type Code	D ₀	P ₀	P ₁	P ₂	T ₂
MCR006	YRT	$\phi 1.5$ ^{+0.1} ₀	4.0±0.1	2.0±0.05	2.0±0.05	Max 0.5
MCR01	MRT	$\phi 1.5$ ^{+0.1} ₀	4.0±0.1	2.0±0.1	2.0±0.05	Max 1.1
MCR03	ERT	$\phi 1.5$ ^{+0.1} ₀	4.0±0.1	4.0±0.1	2.0±0.05	Max 1.1
MCR10	EZH	$\phi 1.5$ ^{+0.1} ₀	4.0±0.1	4.0±0.1	2.0±0.05	Max 1.1
MCR18	EZH	$\phi 1.5$ ^{+0.1} ₀	4.0±0.1	4.0±0.1	2.0±0.05	Max 1.1

■ Embossed Tape

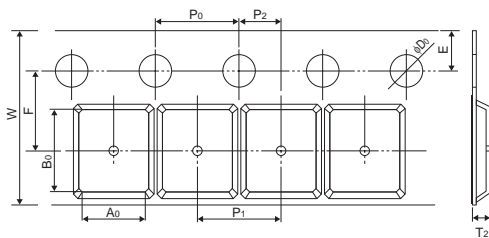

(Unit : mm)

Part No.	Type Code	W	F	E	A ₀	B ₀
MCR25	JZH	8.0±0.3	3.5±0.05	1.75±0.1	3.0±0.1	3.5±0.1
MCR50	JZH	12±0.3	5.5±0.05	1.75±0.1	3.4±0.2	5.6±0.2
MCR100	JZH	12±0.3	5.5±0.05	1.75±0.1	3.5±0.2	6.7±0.2

Part No.	Type Code	D ₀	P ₀	P ₁	P ₂	T ₂
MCR25	JZH	$\phi 1.5$ ^{+0.1} ₀	4.0±0.1	4.0±0.1	2.0±0.05	Max 1.1
MCR50	JZH	$\phi 1.5$ ^{+0.1} ₀	4.0±0.1	4.0±0.1	2.0±0.05	Max 1.1
MCR100	JZH	$\phi 1.5$ ^{+0.1} ₀	4.0±0.1	4.0±0.1	2.0±0.05	Max 1.1

●Reel Dimensions

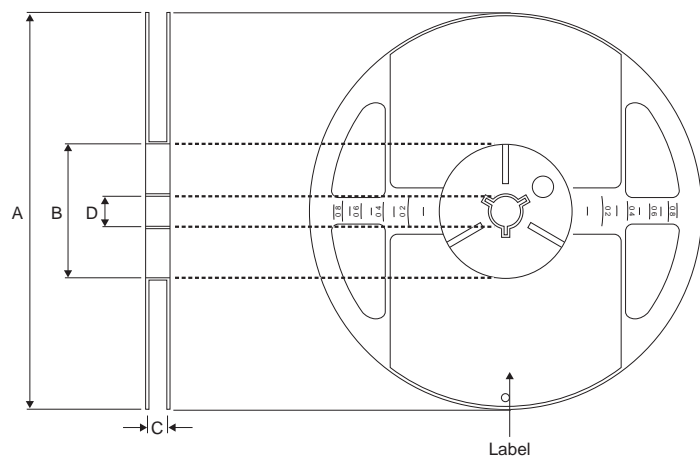

Label
ACCORDING TO EIAJ ET-7200B

(Unit : mm)

Part No.	Type Code	A	B	C	D
MCR006	YRT	$\phi 180 \begin{matrix} 0 \\ -1.5 \end{matrix}$	$\phi 60 \begin{matrix} +1.0 \\ 0 \end{matrix}$	$9 \begin{matrix} +1.0 \\ 0 \end{matrix}$	$\phi 13 \pm 0.2$
MCR01	MRT				
MCR03	ERT				
MCR10	EZH				
MCR18	EZH			$13 \begin{matrix} +1.0 \\ 0 \end{matrix}$	
MCR25	JZH				
MCR50	JZH				
MCR100	JZH				

Notes

No copying or reproduction of this document, in part or in whole, is permitted without the consent of ROHM Co.,Ltd.

The content specified herein is subject to change for improvement without notice.

The content specified herein is for the purpose of introducing ROHM's products (hereinafter "Products"). If you wish to use any such Product, please be sure to refer to the specifications, which can be obtained from ROHM upon request.

Examples of application circuits, circuit constants and any other information contained herein illustrate the standard usage and operations of the Products. The peripheral conditions must be taken into account when designing circuits for mass production.

Great care was taken in ensuring the accuracy of the information specified in this document. However, should you incur any damage arising from any inaccuracy or misprint of such information, ROHM shall bear no responsibility for such damage.

The technical information specified herein is intended only to show the typical functions of and examples of application circuits for the Products. ROHM does not grant you, explicitly or implicitly, any license to use or exercise intellectual property or other rights held by ROHM and other parties. ROHM shall bear no responsibility whatsoever for any dispute arising from the use of such technical information.

The Products specified in this document are intended to be used with general-use electronic equipment or devices (such as audio visual equipment, office-automation equipment, communication devices, electronic appliances and amusement devices).

The Products specified in this document are not designed to be radiation tolerant.

While ROHM always makes efforts to enhance the quality and reliability of its Products, a Product may fail or malfunction for a variety of reasons.

Please be sure to implement in your equipment using the Products safety measures to guard against the possibility of physical injury, fire or any other damage caused in the event of the failure of any Product, such as derating, redundancy, fire control and fail-safe designs. ROHM shall bear no responsibility whatsoever for your use of any Product outside of the prescribed scope or not in accordance with the instruction manual.

The Products are not designed or manufactured to be used with any equipment, device or system which requires an extremely high level of reliability the failure or malfunction of which may result in a direct threat to human life or create a risk of human injury (such as a medical instrument, transportation equipment, aerospace machinery, nuclear-reactor controller, fuel-controller or other safety device). ROHM shall bear no responsibility in any way for use of any of the Products for the above special purposes. If a Product is intended to be used for any such special purpose, please contact a ROHM sales representative before purchasing.

If you intend to export or ship overseas any Product or technology specified herein that may be controlled under the Foreign Exchange and the Foreign Trade Law, you will be required to obtain a license or permit under the Law.



Thank you for your accessing to ROHM product informations.
More detail product informations and catalogs are available, please contact us.

ROHM Customer Support System

<http://www.rohm.com/contact/>