

Separate type · digital sensor controller

DPC-L100 Series

For liquid / gas

MJE-DPCL100 No. 0015-64V

Thank you very much for purchasing Panasonic products. Read this Instruction Manual carefully and thoroughly for the correct and optimum use of this product. Kindly keep this manual in a convenient place for quick reference.

WARNING

- Never use this product as a device for personnel protection.
- In case of using devices for personnel protection, use products which meet laws and standards, such as OSHA, ANSI or IEC etc., for personnel protection applicable in each region or country.
- The product for use inside Japan complies with Japanese Measurement Laws. Avoid using the product model for outside of Japan within Japan.

1 PART DESCRIPTION

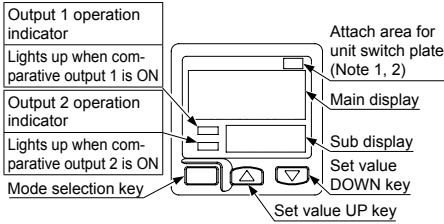

Notes: 1) Attach the unit switch plate corresponds to the set pressure unit.
2) The product for use inside Japan can be set only to "MPa" or "kPa."

Connector area for a power supply / I-O cable

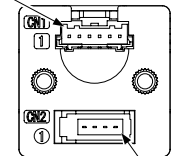

Connector area for a pressure sensor head

2 MOUNTING

- The sensor mounting bracket **MS-DP1-6** is available as an option. When mounting the sensor onto the sensor mounting bracket, etc., the tightening torque should be 0.5N·m or less.
- The panel mounting bracket **MS-DP1-2** (optional), as well as the front cover **MS-DP1-3** (optional) are also available.
- For mounting of the panel mounting bracket, refer to the Instruction Manual enclosed with **MS-DP1-2**.

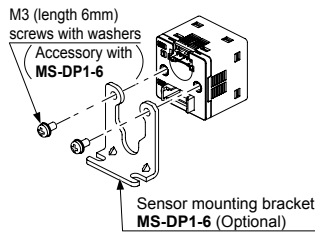

3 CONNECTION OF PRESSURE SENSOR HEAD

- In case of initial set up or reset, select pressure range.
- In case of changing pressure sensor head, check pressure range.

Connection method

1. Insert the pressure sensor head cable into the product's connector area for the pressure sensor head as shown in the right figure.

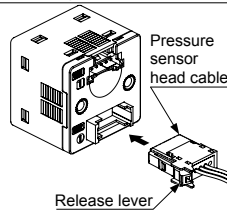

Disconnection method

1. Pressing the release lever of the pressure sensor head cable, pull out the connector.

Note: Do not pull by holding the cable without pressing the release lever, as this can cause cable break or connector break.

<Terminal pin arrangement>

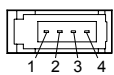

Terminal pin No.	Terminal name
1	Sensor head supply voltage
2	Analogue input
3	0V
4	Not used

4 WIRING

Connection method

1. Insert cable with connector **CN-66A-C** into the product's connector area for a power / I-O cable as shown in the right figure.

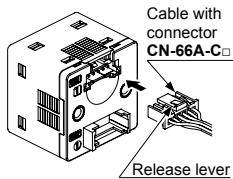

Disconnection method

1. Pressing the release lever of the cable with connector, pull out the connector.

Note: Do not pull by holding the cable without pressing the release lever, as this can cause cable break or connector break.

<Terminal pin arrangement>

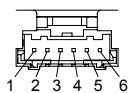

Terminal pin No.	Terminal name	Terminal pin No.	Terminal name
1	+V	4	Comparative output 1
2	Analogue voltage / current output	5	Comparative output 2
3	0V	6	External input

5 I/O CIRCUIT DIAGRAMS

NPN output type

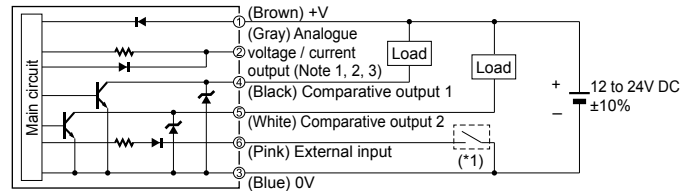

PNP output type

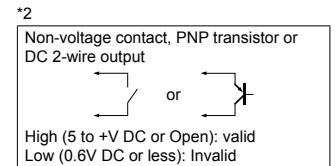
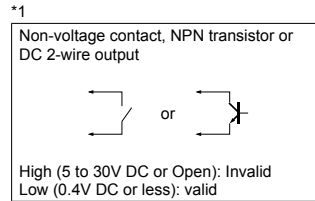
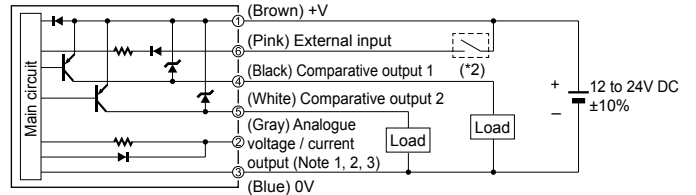

Notes: 1) When the analogue current is output, the output load resistance should be 250Ω max.
2) Take care that when the analogue current is output, 5V or more voltage generates.
3) When using the analogue voltage output, be careful to the input impedance of the connected device. Furthermore, note that if the cable is extended, the cable resistance will cause the voltage to drop.

6 OUTPUT MODE AND OUTPUT OPERATION

- The EASY mode, hysteresis mode or window comparator mode can be selected as the output mode for comparative output 1 and comparative output 2. Refer to **<Comparative output 1 / 2 output mode setting>** in **"MENU SETTING MODE"** for details.

EASY mode

- ON / OFF of the comparative output is controlled in this mode.

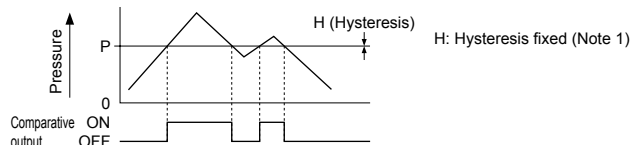

Notes: 1) Hysteresis can be fixed in 8 steps. Refer to **<Hysteresis fixed value selection>** in **"PRO MODE"** for setting.
2) "P-1" is displayed for comparative output 1 and "P-2" for comparative output 2 on the sub-display.

Hysteresis mode

- The comparative output ON / OFF state can be controlled with randomly set hysteresis in this mode.

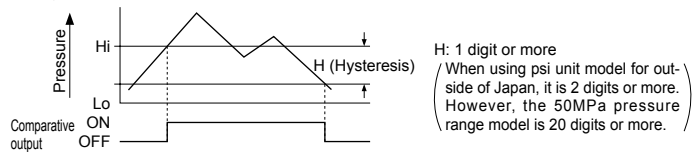

Notes: 1) "Hi-1" or "Lo-1" is displayed for comparative output 1 and "Hi-2" or "Lo-2" is displayed for comparative output 2 on the sub-display.

Window comparator mode

- In this mode, the ON or OFF state of the comparative output is controlled with a pressure in the set range.

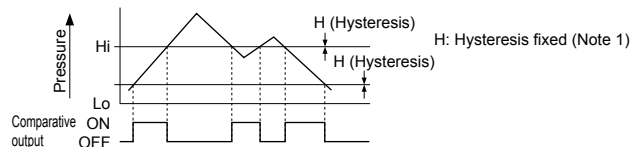

Notes: 1) Hysteresis can be fixed in 8 steps. Refer to **<Hysteresis fixed value selection>** in **"PRO MODE"** for setting.
2) "Hi-1" or "Lo-1" is displayed for comparative output 1 and "Hi-2" or "Lo-2" is displayed for comparative output 2 on the sub-display.

7 SETTING WHEN TURNING ON THE POWER

- After turning ON the power, set pressure range of pressure sensor head connected to this product. The set pressure range is memorized and the range is displayed every time after tuning on the power. Then, move to RUN mode.
- In case replacing sensor head or resetting it, set the pressure range again.

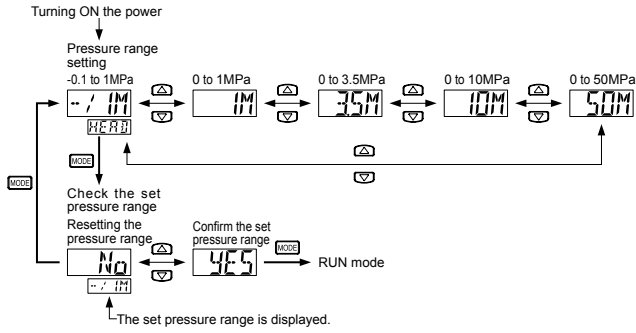

8 RUN MODE

Setting the threshold value

- Refer to <Comparative output 1 / 2 output mode setting> in "9 MENU SETTING MODE" for setting conditions.
- The Sub display conducts the threshold value. Main display does not changed.

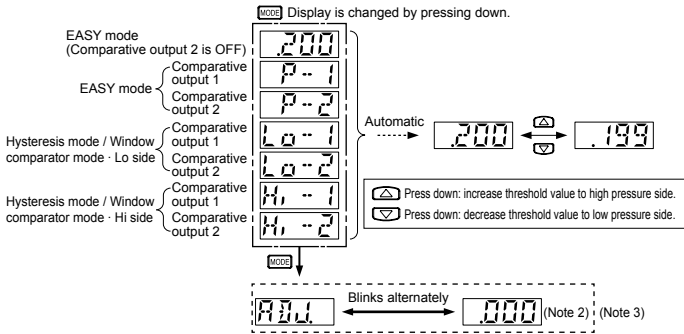

- Notes: 1) If the set pressure range is exceeded, "UP" (exceeds the upper limit) or "DOWN" (exceeds the lower limit) will appear on the sub display. "DOWN" will also appear if the Hi side threshold value exceeds the Lo side threshold value when setting the "hysteresis mode / window comparator mode" threshold value.
- 2) Auto-reference value and remote zero-adjustment value are displayed. For details, refer to "10 AUTO-REFERENCE FUNCTION" and "11 REMOTE ZERO-ADJUSTMENT FUNCTION."
- 3) In the dash line box is not displayed when not setting "AREF" or "ZERO" in external input switch. For the setting method, refer to <Function setting> in "9 MENU SETTING MODE."

Zero-adjustment function

- The zero-adjustment function forcibly sets the pressure value to "zero" when the pressure port is opened.

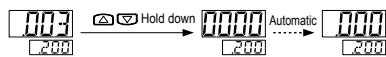

Note: Even if the zero-adjustment is conducted, the analogue voltage / current output is not influenced.

Key lock function

- The key lock function prevents key operations so that the conditions set in each setting mode are not inadvertently changed.

<Key lock set>

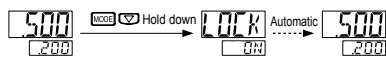

<Key lock released>

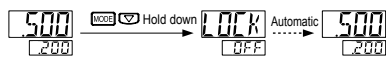

Peak / bottom hold function

- The peak / bottom hold functions display the peak value and bottom value of the fluctuating pressure. For detail, refer to "16 PEAK / BOTTOM HOLD FUNCTION."
- The peak value is displayed on the main display and the bottom value is displayed on the sub display.
- the higher vacuum side indicates the peak value, while the lower vacuum side indicates the bottom value.

<Peak / bottom hold set>



<Peak / bottom hold released>



9 MENU SETTING MODE

- The mode will change to RUN mode when the mode selection key is held down during this setting process. In doing so, changed items before holding down the mode selection key have been set.

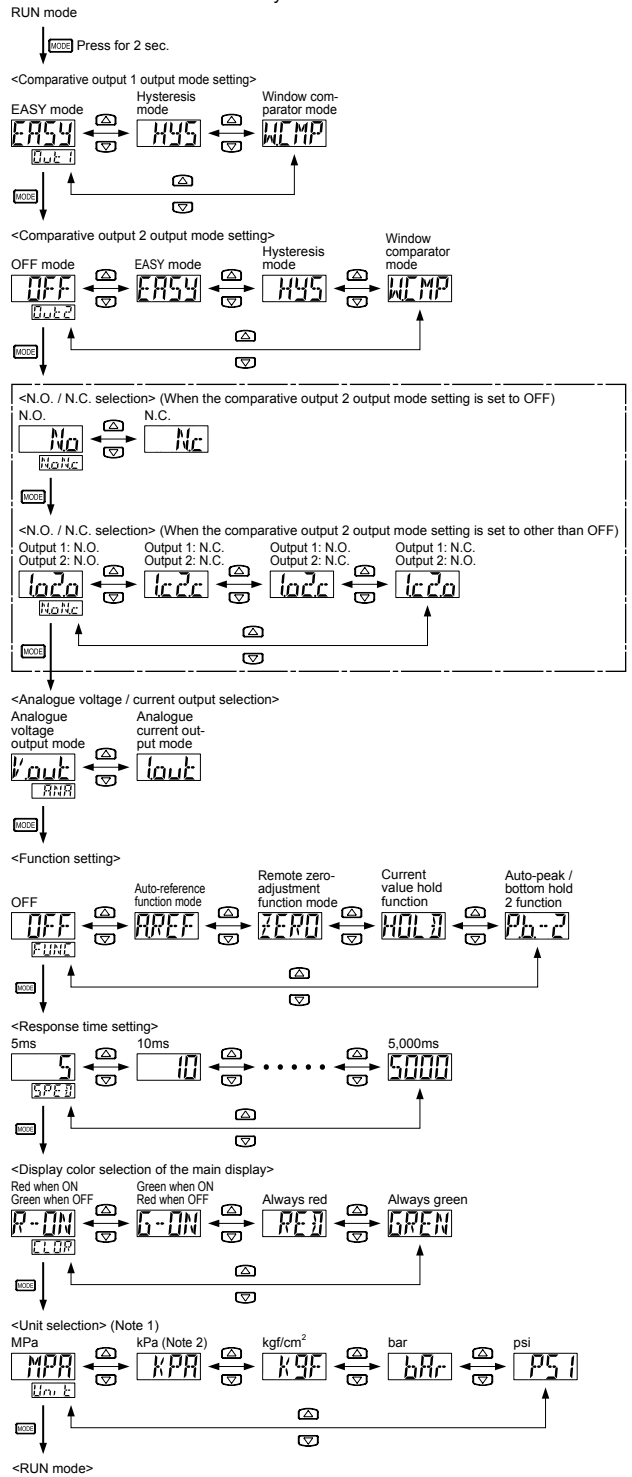

- Note: 1) In case connecting pressure range 1MPa type of pressure sensor head to Japanese model controller, only "MPa" or "kPa" can be set. Also, in case connecting 3.5MPa or more type, setting item for unit change is not displayed.
- 2) in case of connecting pressure range 3.5MPa type of sensor head to out side of japan type controller. "kPa" is not displayed.

Setting Item	Factory setting	Description
Comparative output 1 output mode setting	EASY	Sets comparative output 1 output mode.
Comparative output 2 output mode setting	OFF	Sets comparative output 2 output mode.
N.O. / N.C. selection	NO	Sets when Nomal Open (N.O.) or Normal Close (N.C.). Initial state of excepting OFF of the comparative output 2 setting is "lo2o."
Analogue voltage / current output selection	Vout	Selects Analogue voltage output or analogue current output.
Function setting	OFF	Sets Auto-reference function or remote zero-adjustment function and current value hold function or peak / bottom 2 function.
Response time setting	5	Sets response time. The response time can be select from 5ms, 10ms, 25ms, 50ms, 100ms, 250ms, 500ms, 1,000ms or 5,000ms.
Display color selection of the main display	R-ON	Selects display color of main display.
Unit selection	MPa	Selects pressure unit.

10 PRO MODE

- The mode will change to RUN mode when the mode selection key is held down during this setting process. However, changed items before holding down the mode selection key have been set.

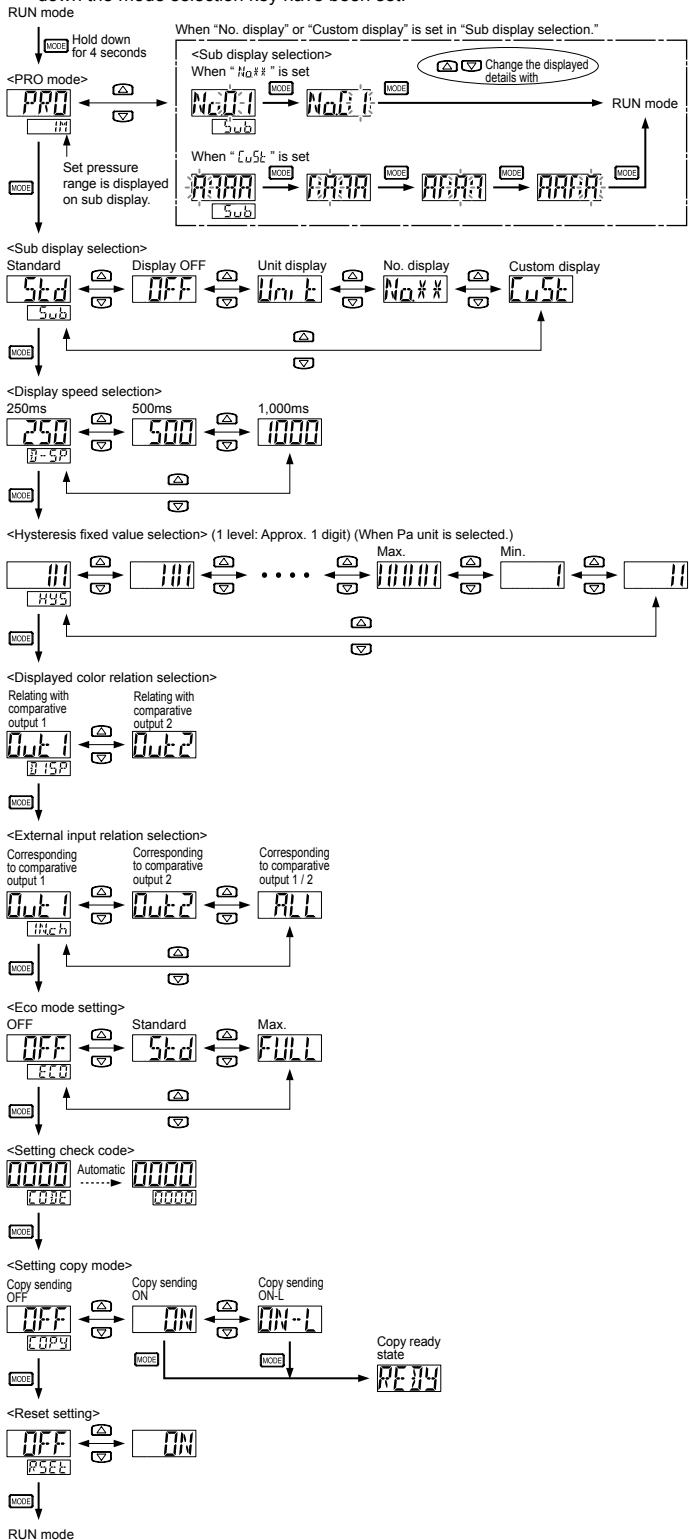

Setting item	Factory setting	Description
Sub display selection	Std	Changes the indication of the sub display in RUN mode. "OFF": Displays nothing. "Unit": Current pressure unit is displayed. "No.": Desired No. can be shown. "Custom": Desired numbers, alphabets (some of them cannot be displayed) and signs can be shown.
Display speed selection	250	Changes the speed of the displayed pressure value on the main display.
Hysteresis fixed value selection	01	Sets hysteresis of the EASY mode and the window comparator mode. (8 steps)
Displayed color relation selection	Out 1	The setting contents set at the displayed color setting in Menu setting mode can be related with either comparative output 1 or comparative output 2.
External input relation selection	Out 1	The setting contents set at auto reference function and remote zero-adjustment function can be shifted to correspond to either comparative output 1, 2 or 1/2.
Eco mode setting	OFF	Current consumption can be lowered. "OFF": Normal operation (ECO mode is OFF.) "Std": If any key operation is not carried out for approx. 5 sec. in RUN mode, the display becomes dark. "Full": If any key operation is not carried out for approx. 5 sec. in RUN mode, the display is turned OFF. Press any key to temporarily show the normal indication.
Setting check code	0000	Current setting contents can be checked. For codes, refer to "Code table."
Setting copy mode	OFF	The setting of the master side sensor can be copied to the slave side sensors. For details, refer to "SETTING COPY FUNCTION." "ON": The setting contents are copied. "ON-L": The setting contents are copied, and the slave side sensor goes into key-lock state.
Reset setting	OFF	Returns to default settings (factory settings). By pressing down mode key when "ON" mode, becomes default settings (factory settings).

Code table

Main display (first digit form left)

Code	1st digit	2nd digit	3rd digit	4th digit
0	Comparative output 1 output mode	Comparative output 2 output mode	Analogue output	Threshold display
1	N.O. / N.C. selection	N.O. / N.C. selection	Analogue voltage output	External input
2	EASY	OFF	Analogue current output	Threshold value 1
3	Hysteresis	EASY		Threshold value 2
4	N.C.	Hysteresis		Threshold value 3
5	N.O.	N.C.	Threshold value 4	HOLD
6	N.C.	N.C.	Threshold value 1	P.b.-2
7	N.O.	Window comparator	Threshold value 2	-
	-	-	Threshold value 3	-
	-	-	Threshold value 4	-

(AREF: Auto-reference function, ZERO: Remote zero-adjust function, HOLD: Current value hold function P.b.-2: peak / bottom hold 2 function)

Sub-display (5th digit from left)

Code	5th digit	6th digit	7th digit	8th digit
0	Displayed color of the main display	Response time	Unit selection (Note)	Display speed
1	Red when ON	Comparative output 1 relation	MPa	Eco mode
2	Green when ON	Comparative output 2 relation	kPa	250ms
3	Always red	Comparative output 1	kgf/cm ²	500ms
4	Always green	Comparative output 2	psi	1,000ms
5	-	5ms	-	std
6	-	10ms	-	Full
7	-	25ms	-	OFF
8	-	50ms	-	std
9	-	100ms	-	Full
	-	250ms	-	-
	-	500ms	-	-
	-	1,000ms	-	-
	-	5,000ms	-	-

11 SETTING COPY FUNCTION

- This can copy the settings of the master side sensor to the slave side sensor.
- Be sure to use the setting copy function between the identical models. This function cannot be used between different models.
- Only one sensor can be connected on slave side with a master side sensor for the setting copy function.
- Do not use the setting copy function other than the following wiring, as pulsed output generates when turning the power ON after setting the master side sensor to the copy ready state.

Setting procedure

- Set the setting copy function of the master side sensor to "Copy sending ON" or "Copy sending ON-L" with the pressure sensor head connected, and then press the mode selection key so that the sensor is in copy ready state. For details, refer to <Setting copy mode> in "10 PRO MODE."
- Turn OFF the master side sensor.
- Remove the pressure sensor head and connect the master side sensor with the slave side sensor as shown below.

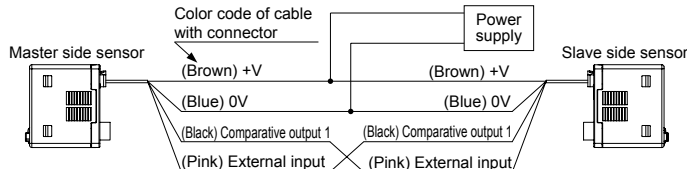

- Turn ON the master side sensor and the slave side sensor at the same time. (Note)
- Set contents (16-bit coded) are shown in orange on the main display of the master side sensor and the copying starts.
- The same code explained above is shown in green on the main display of the slave side sensor, and "OK" is shown on the sub display (When copying is complete.)
- Turn OFF the power of the master side sensor and the slave side sensor and disconnect the wire.

* If copying the setting to another sensor repeatedly, follow steps 3 to 7.

Note: Take care that if the power is not turned on at the same time, the setting contents may not be copied.

To cancel the setting copy mode of master side sensor

- While the slave side sensor is disconnected, turn on the power of the master side sensor.
- Press the mode selection key for approx. 2 seconds.

12 AUTO-REFERENCE FUNCTION

- The auto-reference function corrects the set value using the detected pressure value during auto-reference input as the reference pressure.
- Using the detected pressure value at auto-reference input P(a) as a reference, the set value 1' is automatically corrected to "set value 1 + P(a)."

Settable range and set pressure range after correction

- The setting pressure range is wider than the rating pressure range so that the auto-reference function can be handled.

If the corrected set value exceeds the set pressure range when auto-reference input is carried out, the set value will be automatically corrected to within the set pressure range. Thus, take care not to exceed the set pressure range.

Operation chart

Ⓛ During normal operation
(each comparative output set to N.O.)

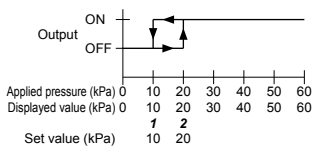

Ⓛ During auto-reference input
(each comparative output set to N.O.)

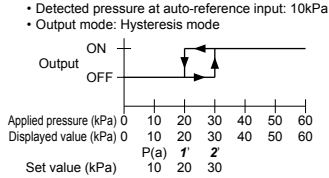

Note: The set values shift in the same manner during the EASY mode or the window comparator mode.

- The detected pressure value at auto-reference input becomes "zero" when the setting of the analogue voltage / current output selection function is changed or the power is turned ON again.
- The auto-reference input value can be checked when setting the threshold value in RUN mode. Refer to "Threshold value setting" in "8 RUN MODE" for details.

13 REMOTE ZERO-ADJUSTMENT FUNCTION

- The remote zero-adjustment function forcibly sets the pressure value to "zero" when the external signal is input.

The setting value is not corrected when remote zero-adjustment is input. Make sure that the pressure and set value during remote zero-adjustment do not exceed the set pressure range.

Operation chart

Ⓛ During normal operation
(each comparative output set to N.O.)

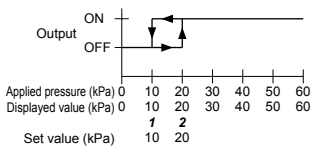

Ⓛ During remote zero-adjustment input
(each comparative output set to N.O.)

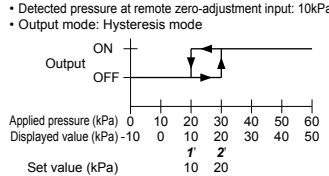

Notes: 1) The setting values shift in the same manner during the EASY mode or the window comparator mode.
2) The remote zero-adjustment function is applicable only to the comparative output set at the external input relation selection. Unset comparative output operates based on the atmospheric pressure.

- The remote zero-adjustment value is cleared when the setting of the analogue voltage / current output selection is changed or the power is turned ON again, and normal operation based on the atmospheric pressure is resumed.
- The remote zero-adjustment value can be confirmed when setting the threshold value in RUN mode. Refer to the threshold value setting in "8 RUN MODE"

14 CURRENT VALUE HOLD FUNCTION

- During turning ON the external input, it display continuously current pressure value.
- Even if holding the display, it is possible to determine output and to change threshold value.
- In case display is held, actual value is not displayed. be sure that impressed pressure not exceed the specified value.

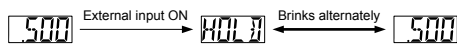

15 PEAK / BOTTOM HOLD FUNCTION

- In case setting peak / bottom hold 1 setting, displays peak value and bottom value in same time after setting.
- In case of setting peak / bottom hold 2 setting, displays both peak value and bottom value in same time in conjunction with output.
In case power is ON (OFF), hold the display until next output is ON (OFF). the set value in conjunction with output.
However, in case of setting window comparator, it operate as peak / bottom hold 1 setting.
- For setting method, refer to "Peak / bottom hold function" in "8 RUN MODE."

<Peak hold 2>

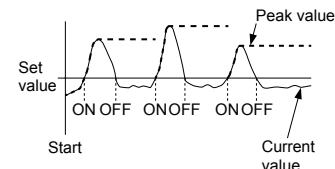

<Bottom hold 2>

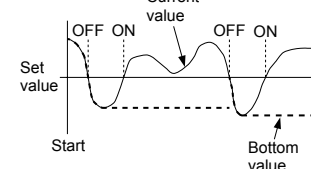

16 CAUTIONS

- This product has been developed / produced for industrial use only.
- Make sure that the power supply is OFF while wiring.
- Take care that if a voltage exceeding the rated range is applied, or if an AC power supply is directly connected, the product may get burnt or damaged.
- Take care that wrong wiring will damage the sensor.
- Do not run the wires together with high-voltage lines or power lines or put them in the same raceway. This can cause malfunction due to induction.
- If power is supplied from a commercial switching regulator, ensure that the frame ground (F.G.) terminal of the power supply is connected to an actual ground.
- In case noise generating equipment (switching regulator, inverter motor, etc.) is used in the vicinity of this sensor, connect the frame ground (F.G.) terminal of the equipment to an actual ground.
- Do not use during the initial transient time (0.5 sec.) after the power supply is switched on.
- Extension up to total 100m (emitter and receiver each for thru-beam type), or less, is possible with 0.3mm², or more of conductor cross-section area cable. However, to reduce noise, make the wiring as short as possible. If using this product as complaint model with CE mark, the power supply line must be 30m or less.

- Make sure that stress by forcible bend or pulling is not applied directly to the sensor cable joint.
- This sensor is suitable for indoor use only.
- Avoid dust, dirt, and steam.
- Take care that the product does not come in contact with water, oil, grease, or organic solvents, such as, thinner, etc.
- Do not operate the keys with pointed or sharp objects.
- Do not use this sensor in places having excessive vapor, dust, etc., or where it may come in contact with corrosive gas, etc.
- Never disassemble or modify the sensor.
- This product use EEPROM. The EEPROM has lifetime and cannot set more than 1 million times of setting.

17 ERROR INDICATION

- When error is occurred, use the countermeasure listed blow.

Error message	Cause	Corrective action
E-0	• The controller and the pressure sensor head are not correctly connected. • The pressure sensor head is damaged.	• Connect the controller and the pressure sensor head correctly. • Replace the pressure sensor head.
E-1	The load is short-circuited causing an over-current to flow.	Turn the power OFF and check the load.
E-3	Pressure is applied during zero-point adjustment.	Applied pressure at the pressure port should be brought to atmospheric pressure and zero-point adjustment should be done again.
E-4	External input is carried out outside the rated pressure range.	Applied pressure range should be brought within the rated pressure range.
E-5	Communication error (Disconnection, faulty connection, etc.)	Check the wiring when using the copy function.
E-6	Communication error (Incorrect model.)	Make sure that the system is configured of the same models when using the copy function.
XXXX	The applied pressure exceeds the upper limit of the display pressure range.	Applied pressure range should be brought within the rated pressure range. The output is kept.
----XXXX	The applied pressure exceeds the lower limit of the display pressure range.	

When other error message is displayed, contact us.

18 SPECIFICATIONS

Type	NPN output type		PNP output type	
	For inside of Japan	For outside of Japan	For inside of Japan	For outside of Japan
Model No.	DPC-L101Z	DPC-L101	DPC-L101Z-P	DPC-L101-P
Applicable pressure sensor head	DPH-L113V, DPH-L113, DPH-L133, DPH-L114, DPH-L154			
Rated pressure range	-0.1 to 1MPa / 0 to 1MPa / 0 to 3.5MPa / 0 to 10MPa / 0 to 50MPa			
Set pressure range	-1.177 to 1.177MPa / -1.070 to 1.070MPa / -3.74 to 3.74MPa / -10.70 to 10.70MPa / -53.5 to 53.5MPa			
Supply voltage	12 to 24V DC $\pm 10\%$ Ripple P-P 10% or less			
Power consumption (Note 2)	Normal operation: 960mW or less (current consumption 40mA or less at 24V supply voltage) ECO mode (STD): 720mW or less (current consumption 30mA or less at 24V supply voltage) ECO mode (FULL): 600mW or less (current consumption 25mA or less at 24V supply voltage)			
Sensor head supply voltage	Same as supply voltage			
Input	Pressure sensor head input	Input voltage range: 1 to 5V DC (within the rated pressure range)		
	External input	• ON voltage: 0.4V DC or less • OFF voltage: 5 to 30V DC or open • Input impedance: Approx. 10k Ω • Input time: 1ms or more	• ON voltage: 5V to +V DC • OFF voltage: 0.6V DC or less or open • Input impedance: Approx. 10k Ω • Input time: 1ms or more	
Comparative output (Comparative output 1/2)	NPN open-collector transistor • Maximum sink current: 50mA • Applied voltage: 30V DC or less (between comparative output and OV) • Residual voltage: 1V or less (at 50mA sink current)		PNP open-collector transistor • Maximum source current: 50mA • Applied voltage: 30V DC or less (between comparative output and +V) • Residual voltage: 1V or less (at 50mA source current)	
Output operation	Selectable either N.O. or N.C., with key operation			
Hysteresis	Minimum 1 digit			
Repeatability	Within $\pm 0.2\%$ F.S.			
Response time	5ms, 10ms, 25ms, 50ms, 100ms, 250ms, 500ms, 1,000ms or 5,000ms selectable with key operations			
Analogue output	<Analogue voltage output> • Output voltage: 1 to 5V • Output impedance: Approx. 1k Ω • Zero point: Within 1V $\pm 0.5\%$ F.S. (DPH-L113V: Within 1.364V $\pm 0.5\%$ F.S.) • Span: Within 4V $\pm 0.5\%$ F.S. • Linearity: Within $\pm 0.1\%$ F.S.		<Analogue current output> • Output current: 4 to 20mA • Load resistance: 250 Ω (MAX.) • Zero point: within 4mA $\pm 1\%$ F.S. (DPH-L113V: within 5.455mA $\pm 1\%$ F.S.) • Span: Within 16mA $\pm 1.5\%$ F.S. • Linearity: Within $\pm 0.1\%$ F.S.	
	Ambient temperature: -10 to +50°C (No dew condensation or icing allowed), Storage: -10 to +60°C			
Ambient humidity	35 to 85% RH, Storage: 35 to 85% RH			
Material	Enclosure: PBT (with glass fiber), LCD display: Acrylic Mounting screw section: Brass (nickel-plated), Switch: Silicon rubber			
Weight (Main body only)	Approx. 25g			
Accessories	CN-66A-C2 (Cable with a connector, 2m long) (Optional for J type): 1 pc. Unit switching label: 1 pc.			

Notes: 1) The cable with connector is not enclosed with models that have "J" at the end of the model names.
2) Excluding the current consumption of analogue output current and applying pressure sensor head.
3) The specified value is only for controller. Refer to attached instruction manual of pressure sensor head of used as combination for specified value.

19 CE MARKED PRODUCT

- The models listed under "18 SPECIFICATIONS" come with CE Marking. As for all other models, please contact us.



Panasonic Electric Works SUNX Co., Ltd.

http://panasonic-electric-works.net/sunx

Overseas Sales Division (Head Office)

2431-1 Ushiyama-cho, Kasugai-shi, Aichi, 486-0901, Japan

Phone: +81-568-33-7861 FAX: +81-568-33-8591

Europe Headquarter: Panasonic Electric Works Europe AG

Rudolf-Diesel-Ring 2, D-83607 Holzkirchen, Germany

Phone: +49-8024-648-0

US Headquarter: Panasonic Electric Works Corporation of America

629 Central Avenue New Providence, New Jersey 07974 USA

Phone: +1-908-464-3550

PRINTED IN JAPAN

© Panasonic Electric Works SUNX Co., Ltd. 2010