

LM7171 Very High Speed, High Output Current, Voltage Feedback Amplifier

Check for Samples: [LM7171](#)

FEATURES

- (Typical Unless Otherwise Noted)
- Easy-to-Use Voltage Feedback Topology
- Very High Slew Rate: 4100 V/ μ s
- Wide Unity-Gain Bandwidth: 200 MHz
- -3 dB Frequency @ $A_V = +2$: 220 MHz
- Low Supply Current: 6.5 mA
- High Open Loop Gain: 85 dB
- High Output Current: 100 mA
- Differential Gain and Phase: 0.01%, 0.02°
- Specified for $\pm 15V$ and $\pm 5V$ Operation

APPLICATIONS

- HDSL and ADSL Drivers
- Multimedia Broadcast Systems
- Professional Video Cameras
- Video Amplifiers
- Copiers/Scanners/Fax
- HDTV Amplifiers
- Pulse Amplifiers and Peak Detectors
- CATV/Fiber Optics Signal Processing

Typical Performance

DESCRIPTION

The LM7171 is a high speed voltage feedback amplifier that has the slewing characteristic of a current feedback amplifier; yet it can be used in all traditional voltage feedback amplifier configurations. The LM7171 is stable for gains as low as +2 or -1. It provides a very high slew rate at 4100V/ μ s and a wide unity-gain bandwidth of 200 MHz while consuming only 6.5 mA of supply current. It is ideal for video and high speed signal processing applications such as HDSL and pulse amplifiers. With 100 mA output current, the LM7171 can be used for video distribution, as a transformer driver or as a laser diode driver.

Operation on $\pm 15V$ power supplies allows for large signal swings and provides greater dynamic range and signal-to-noise ratio. The LM7171 offers low SFDR and THD, ideal for ADC/DAC systems. In addition, the LM7171 is specified for $\pm 5V$ operation for portable applications.

The LM7171 is built on TI's advanced VIP™ III (Vertically integrated PNP) complementary bipolar process.

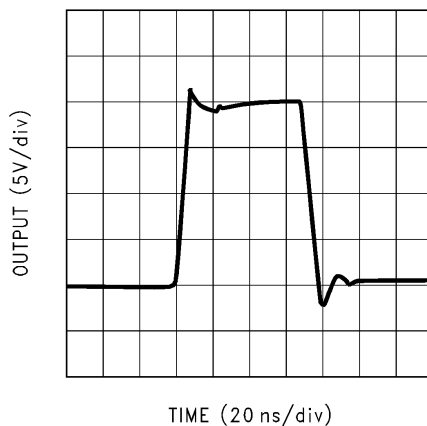

Figure 1. Large Signal Pulse Response
 $A_V = +2, V_S = \pm 15V$



Please be aware that an important notice concerning availability, standard warranty, and use in critical applications of Texas Instruments semiconductor products and disclaimers thereto appears at the end of this data sheet.

VIP is a trademark of Texas Instruments.

All other trademarks are the property of their respective owners.



These devices have limited built-in ESD protection. The leads should be shorted together or the device placed in conductive foam during storage or handling to prevent electrostatic damage to the MOS gates.

Absolute Maximum Ratings ⁽¹⁾

ESD Tolerance ⁽²⁾	2.5 kV
Supply Voltage (V ⁺ –V [–])	36V
Differential Input Voltage ⁽³⁾	±10V
Output Short Circuit to Ground ⁽⁴⁾	Continuous
Storage Temperature Range	–65°C to +150°C
Maximum Junction Temperature ⁽⁵⁾	150°C

- (1) Absolute Maximum Ratings indicate limits beyond which damage to the device may occur. Operating Ratings indicate conditions for which the device is intended to be functional, but specific performance is not specified. For ensured specifications and the test conditions, see the Electrical Characteristics.
- (2) Human body model, 1.5 kΩ in series with 100 pF.
- (3) Input differential voltage is applied at V_S = ±15V.
- (4) Applies to both single-supply and split-supply operation. Continuous short circuit operation at elevated ambient temperature can result in exceeding the maximum allowed junction temperature of 150°C.
- (5) The maximum power dissipation is a function of T_{J(MAX)}, θ_{JA}, and T_A. The maximum allowable power dissipation at any ambient temperature is P_D = (T_{J(MAX)}–T_A)/θ_{JA}. All numbers apply for packages soldered directly into a PC board.

Operating Ratings ⁽¹⁾

Supply Voltage	5.5V ≤ V _S ≤ 36V
Junction Temperature Range	
LM7171AI, LM7171BI	–40°C ≤ T _J ≤ +85°C
Thermal Resistance (θ _{JA})	
8-Pin PDIP	108°C/W
8-Pin SOIC	172°C/W

- (1) Absolute Maximum Ratings indicate limits beyond which damage to the device may occur. Operating Ratings indicate conditions for which the device is intended to be functional, but specific performance is not specified. For ensured specifications and the test conditions, see the Electrical Characteristics.

±15V DC Electrical Characteristics

Unless otherwise noted, all limits are specified for $T_J = 25^\circ\text{C}$, $V^+ = +15\text{V}$, $V^- = -15\text{V}$, $V_{\text{CM}} = 0\text{V}$, and $R_L = 1\text{ k}\Omega$. **Boldface** limits apply at the temperature extremes

Symbol	Parameter	Conditions	Typ (1)	LM7171AI	LM7171BI	Units
				Limit ⁽²⁾	Limit ⁽²⁾	
V_{OS}	Input Offset Voltage		0.2	1	3	mV
				4	7	max
$\text{TC } V_{\text{OS}}$	Input Offset Voltage Average Drift		35			$\mu\text{V}/^\circ\text{C}$
I_{B}	Input Bias Current		2.7	10	10	μA
				12	12	max
I_{OS}	Input Offset Current		0.1	4	4	μA
				6	6	max
R_{IN}	Input Resistance	Common Mode	40			M Ω
		Differential Mode	3.3			
R_{O}	Open Loop Output Resistance		15			Ω
CMRR	Common Mode Rejection Ratio	$V_{\text{CM}} = \pm 10\text{V}$	105	85	75	dB
				80	70	
PSRR	Power Supply Rejection Ratio	$V_{\text{S}} = \pm 15\text{V}$ to $\pm 5\text{V}$	90	85	75	dB
				80	70	
V_{CM}	Input Common-Mode Voltage Range	CMRR > 60 dB	± 13.35			V
A_{V}	Large Signal Voltage Gain ⁽³⁾	$R_L = 1\text{ k}\Omega$	85	80	75	dB
				75	70	
		$R_L = 100\Omega$	81	75	70	dB
				70	66	min
V_{O}	Output Swing	$R_L = 1\text{ k}\Omega$	13.3	13	13	V
				12.7	12.7	
		$R_L = 100\Omega$	-13.2	-13	-13	V
				-12.7	-12.7	
		11.8	10.5	10.5	V	
		-10.5	-9.5	-9.5	V	
				9.5	9.5	min
				9	9	max
	Output Current (Open Loop) ⁽⁴⁾	Sourcing, $R_L = 100\Omega$	118	105	105	mA
				95	95	
	Output Current (in Linear Region)	Sourcing, $R_L = 100\Omega$	100			mA
		Sinking, $R_L = 100\Omega$	100			
I_{SC}	Output Short Circuit Current	Sourcing	140			mA
		Sinking	135			
I_{S}	Supply Current		6.5	8.5	8.5	mA
				9.5	9.5	

(1) Typical values represent the most likely parametric norm.

(2) All limits are specified by testing or statistical analysis.

(3) Large signal voltage gain is the total output swing divided by the input signal required to produce that swing. For $V_{\text{S}} = \pm 15\text{V}$, $V_{\text{OUT}} = \pm 5\text{V}$. For $V_{\text{S}} = \pm 5\text{V}$, $V_{\text{OUT}} = \pm 1\text{V}$.

(4) The open loop output current is specified, by the measurement of the open loop output voltage swing, using 100 Ω output load.

±15V AC Electrical Characteristics

Unless otherwise noted, $T_J = 25^\circ\text{C}$, $V^+ = +15\text{V}$, $V^- = -15\text{V}$, $V_{\text{CM}} = 0\text{V}$, and $R_L = 1\text{ k}\Omega$.

Symbol	Parameter	Conditions	Typ ⁽¹⁾	LM7171AI	LM7171BI	Units
				Limit ⁽²⁾	Limit ⁽²⁾	
SR	Slew Rate ⁽³⁾	$A_V = +2$, $V_{\text{IN}} = 13\text{ V}_{\text{PP}}$	4100			V/ μs
		$A_V = +2$, $V_{\text{IN}} = 10\text{ V}_{\text{PP}}$	3100			
	Unity-Gain Bandwidth		200			MHz
	-3 dB Frequency	$A_V = +2$	220			MHz
Φ_m	Phase Margin		50			Deg
t_s	Settling Time (0.1%)	$A_V = -1$, $V_O = \pm 5\text{V}$ $R_L = 500\Omega$	42			ns
t_p	Propagation Delay	$A_V = -2$, $V_{\text{IN}} = \pm 5\text{V}$, $R_L = 500\Omega$	5			ns
A_D	Differential Gain ⁽⁴⁾		0.01			%
Φ_D	Differential Phase ⁽⁴⁾		0.02			Deg
	Second Harmonic Distortion ⁽⁵⁾	$f_{\text{IN}} = 10\text{ kHz}$	-110			dBc
		$f_{\text{IN}} = 5\text{ MHz}$	-75			dBc
	Third Harmonic Distortion ⁽⁵⁾	$f_{\text{IN}} = 10\text{ kHz}$	-115			dBc
		$f_{\text{IN}} = 5\text{ MHz}$	-55			dBc
e_n	Input-Referred Voltage Noise	$f = 10\text{ kHz}$	14			nV/ $\sqrt{\text{Hz}}$
i_n	Input-Referred Current Noise	$f = 10\text{ kHz}$	1.5			pA/ $\sqrt{\text{Hz}}$

- (1) Typical values represent the most likely parametric norm.
- (2) All limits are specified by testing or statistical analysis.
- (3) Slew Rate is the average of the raising and falling slew rates.
- (4) Differential gain and phase are measured with $A_V = +2$, $V_{\text{IN}} = 1\text{ V}_{\text{PP}}$ at 3.58 MHz and both input and output 75 Ω terminated.
- (5) Harmonics are measured with $V_{\text{IN}} = 1\text{ V}_{\text{PP}}$, $A_V = +2$ and $R_L = 100\Omega$.

±5V DC Electrical Characteristics

Unless otherwise noted, all limits are specified for $T_J = 25^\circ\text{C}$, $V^+ = +5\text{V}$, $V^- = -5\text{V}$, $V_{\text{CM}} = 0\text{V}$, and $R_L = 1\text{ k}\Omega$. **Boldface** limits apply at the temperature extremes

Symbol	Parameter	Conditions	Typ ⁽¹⁾	LM7171AI	LM7171BI	Units
				Limit ⁽²⁾	Limit ⁽²⁾	
V_{OS}	Input Offset Voltage		0.3	1.5	3.5	mV
				4	7	max
$\text{TC } V_{\text{OS}}$	Input Offset Voltage Average Drift		35			$\mu\text{V}/^\circ\text{C}$
I_{B}	Input Bias Current		3.3	10	10	μA
				12	12	max
I_{OS}	Input Offset Current		0.1	4	4	μA
				6	6	max
R_{IN}	Input Resistance	Common Mode	40			$\text{M}\Omega$
		Differential Mode	3.3			
R_{O}	Output Resistance		15			Ω
CMRR	Common Mode Rejection Ratio	$V_{\text{CM}} = \pm 2.5\text{V}$	104	80	70	dB
				75	65	
PSRR	Power Supply Rejection Ratio	$V_{\text{S}} = \pm 15\text{V}$ to $\pm 5\text{V}$	90	85	75	dB
				80	70	
V_{CM}	Input Common-Mode Voltage Range	CMRR > 60 dB	± 3.2			V
A_{V}	Large Signal Voltage Gain ⁽³⁾	$R_L = 1\text{ k}\Omega$	78	75	70	dB
				70	65	
V_{O}	Output Swing	$R_L = 1\text{ k}\Omega$	3.4	3.2	3.2	V
				3	3	min
		$R_L = 100\Omega$	-3.4	-3.2	-3.2	V
			-3	-3	-3	max
I_{SC}	Output Current (Open Loop) ⁽⁴⁾	Sourcing, $R_L = 100\Omega$	31	29	29	mA
				28	28	
		Sinking, $R_L = 100\Omega$	30	29	29	mA
				28	28	
I_{SC}	Output Short Circuit Current	Sourcing	135			mA
		Sinking	100			
I_{S}	Supply Current		6.2	8	8	mA
				9	9	

(1) Typical values represent the most likely parametric norm.

(2) All limits are specified by testing or statistical analysis.

(3) Large signal voltage gain is the total output swing divided by the input signal required to produce that swing. For $V_{\text{S}} = \pm 15\text{V}$, $V_{\text{OUT}} = \pm 5\text{V}$. For $V_{\text{S}} = \pm 5\text{V}$, $V_{\text{OUT}} = \pm 1\text{V}$.

(4) The open loop output current is specified, by the measurement of the open loop output voltage swing, using 100Ω output load.

±5V AC Electrical Characteristics

Unless otherwise noted, all limits are specified for $T_J = 25^\circ\text{C}$, $V^+ = +5\text{V}$, $V^- = -5\text{V}$, $V_{CM} = 0\text{V}$, and $R_L = 1\text{ k}\Omega$.

Symbol	Parameter	Conditions	Typ ⁽¹⁾	LM7171AI	LM7171BI	Units
				Limit ⁽²⁾	Limit ⁽²⁾	
SR	Slew Rate ⁽³⁾	$A_V = +2$, $V_{IN} = 3.5\text{ V}_{PP}$	950			V/ μs
	Unity-Gain Bandwidth		125			MHz
	-3 dB Frequency	$A_V = +2$	140			MHz
ϕ_m	Phase Margin		57			Deg
t_s	Settling Time (0.1%)	$A_V = -1$, $V_O = \pm 1\text{V}$, $R_L = 500\Omega$	56			ns
t_p	Propagation Delay	$A_V = -2$, $V_{IN} = \pm 1\text{V}$, $R_L = 500\Omega$	6			ns
A_D	Differential Gain ⁽⁴⁾		0.02			%
ϕ_D	Differential Phase ⁽⁵⁾		0.03			Deg
	Second Harmonic Distortion ⁽⁶⁾	$f_{IN} = 10\text{ kHz}$	-102			dBc
		$f_{IN} = 5\text{ MHz}$	-70			dBc
	Third Harmonic Distortion ⁽⁶⁾	$f_{IN} = 10\text{ kHz}$	-110			dBc
		$f_{IN} = 5\text{ MHz}$	-51			dBc
e_n	Input-Referred Voltage Noise	$f = 10\text{ kHz}$	14			$\text{nV}/\sqrt{\text{Hz}}$
i_n	Input-Referred Current Noise	$f = 10\text{ kHz}$	1.8			$\text{pA}/\sqrt{\text{Hz}}$

- (1) Typical values represent the most likely parametric norm.
- (2) All limits are specified by testing or statistical analysis.
- (3) Slew Rate is the average of the raising and falling slew rates.
- (4) Absolute Maximum Ratings indicate limits beyond which damage to the device may occur. Operating Ratings indicate conditions for which the device is intended to be functional, but specific performance is not specified. For ensured specifications and the test conditions, see the Electrical Characteristics.
- (5) Differential gain and phase are measured with $A_V = +2$, $V_{IN} = 1\text{ V}_{PP}$ at 3.58 MHz and both input and output 75 Ω terminated.
- (6) Harmonics are measured with $V_{IN} = 1\text{ V}_{PP}$, $A_V = +2$ and $R_L = 100\Omega$.

Connection Diagram

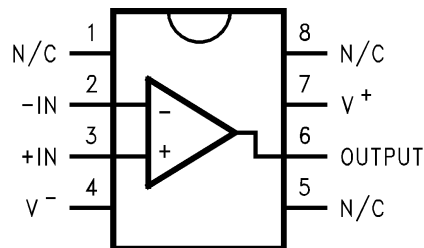

Figure 2. 8-Pin DIP/SOIC
Top View

Typical Performance Characteristics

unless otherwise noted, $T_A = 25^\circ\text{C}$

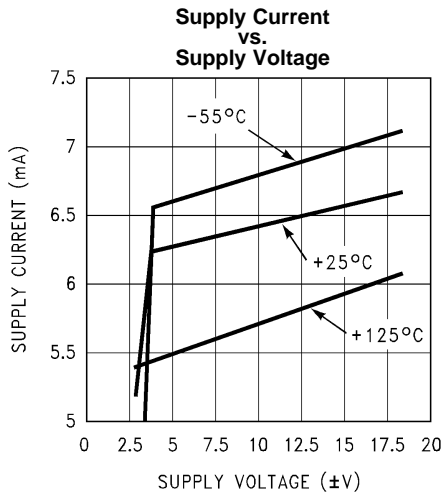

Figure 3.

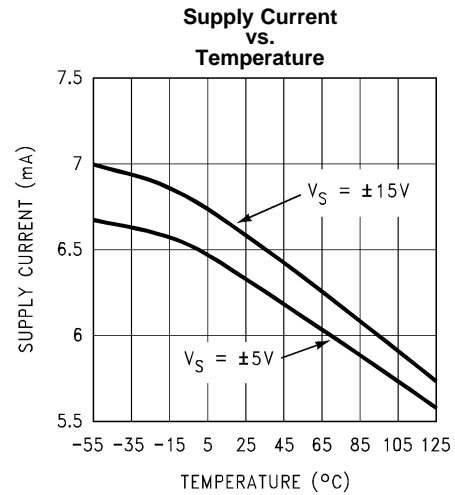

Figure 4.

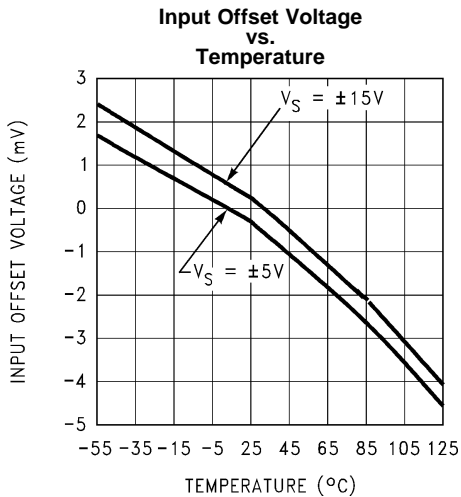

Figure 5.

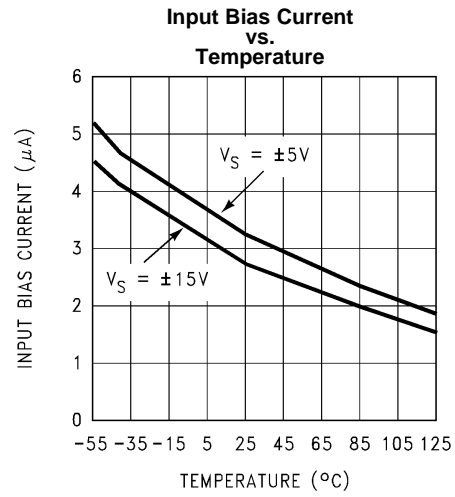

Figure 6.

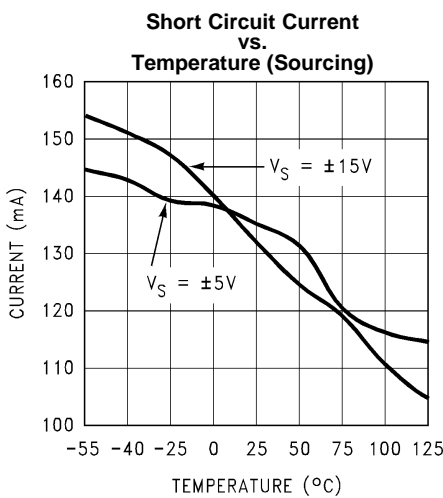

Figure 7.

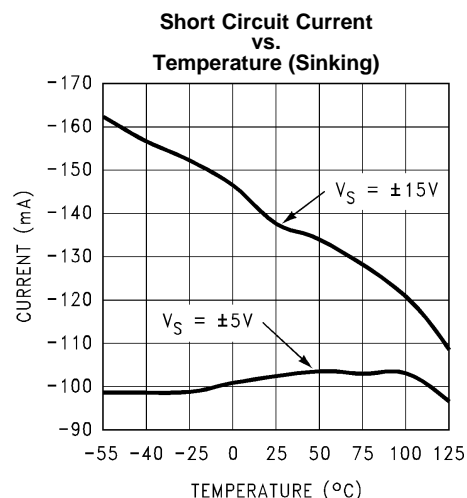

Figure 8.

Typical Performance Characteristics (continued)

unless otherwise noted, $T_A = 25^\circ\text{C}$

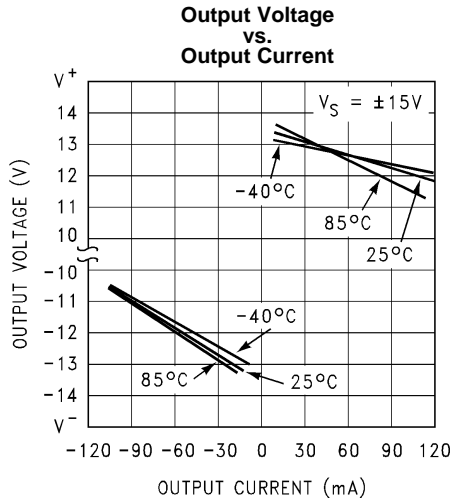

Figure 9.

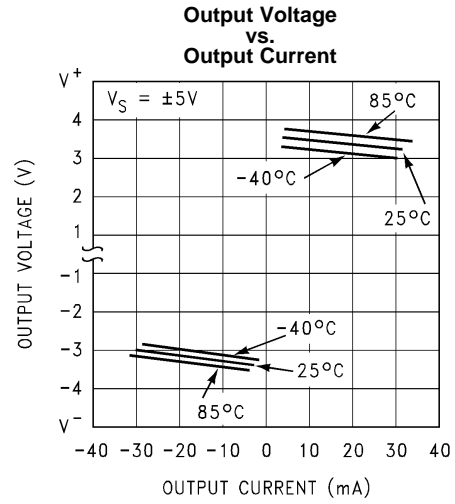

Figure 10.

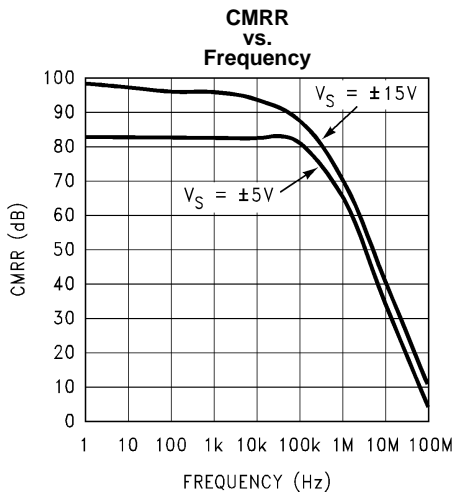

Figure 11.

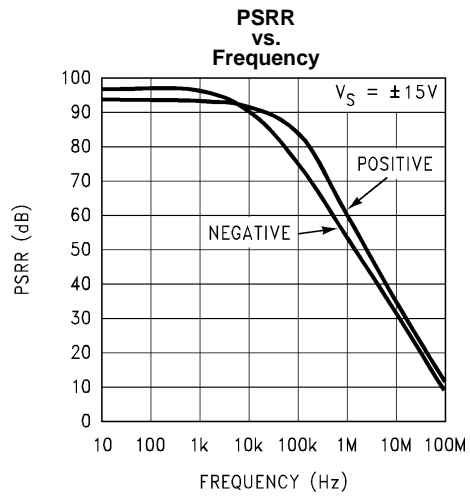

Figure 12.

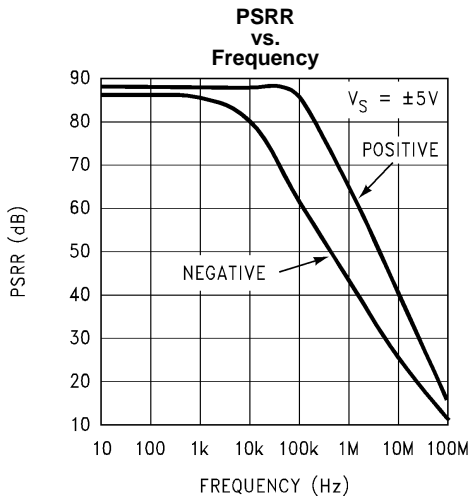

Figure 13.

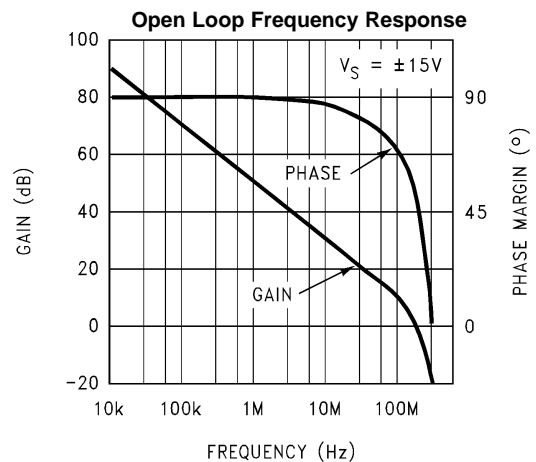

Figure 14.

Typical Performance Characteristics (continued)

unless otherwise noted, $T_A = 25^\circ\text{C}$

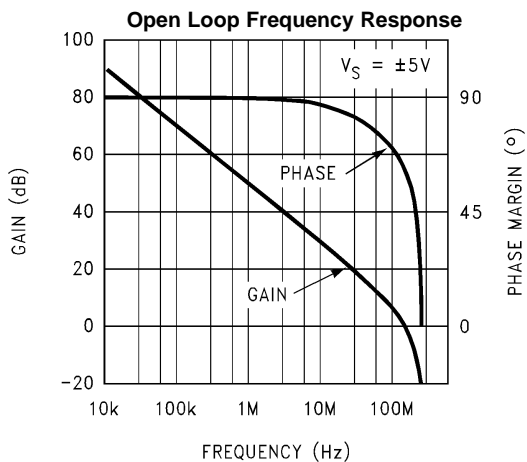

Figure 15.

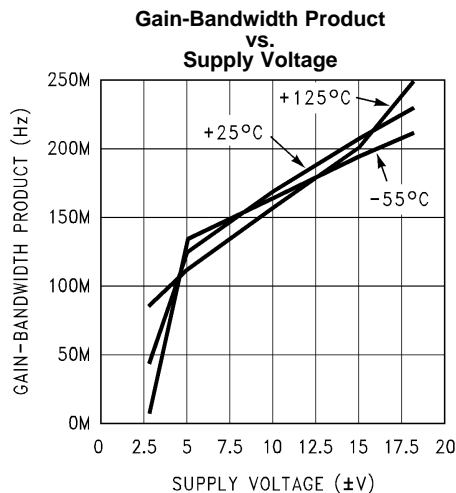

Figure 16.

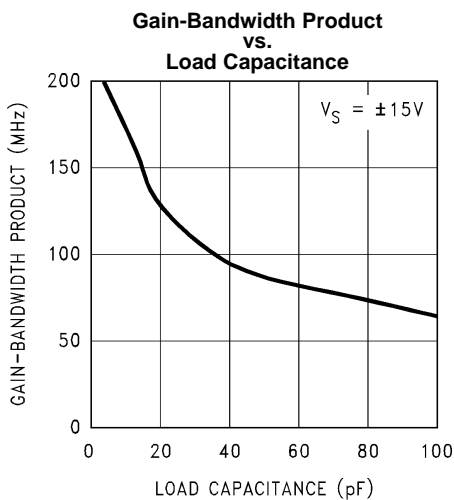

Figure 17.

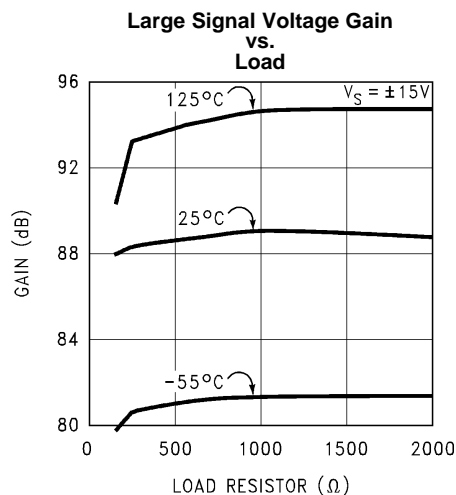

Figure 18.

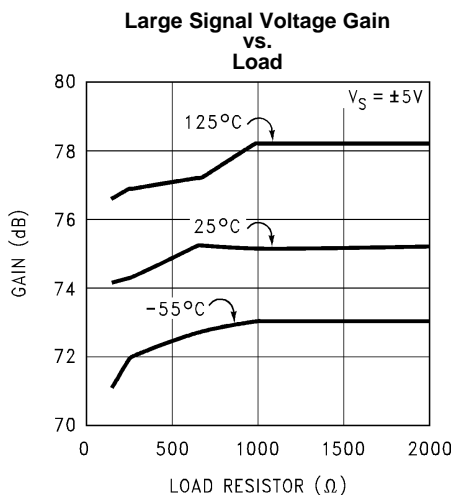

Figure 19.

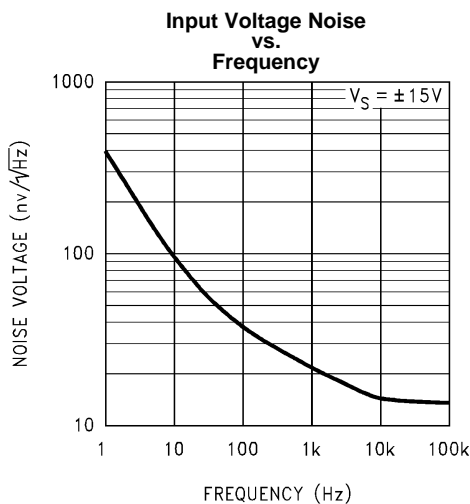
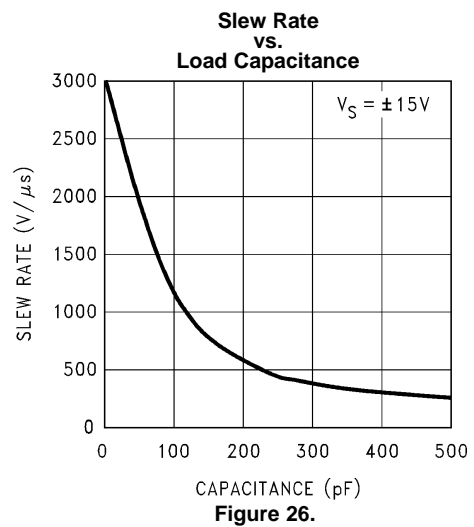
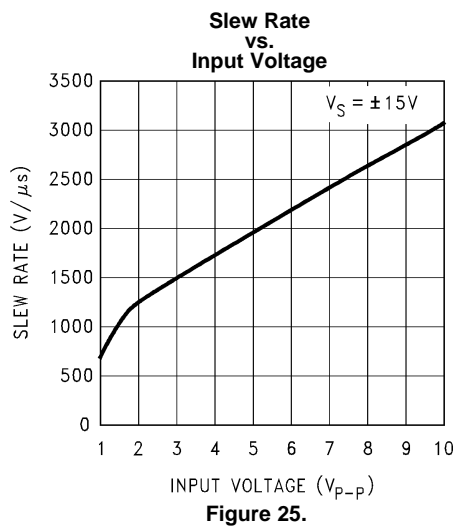
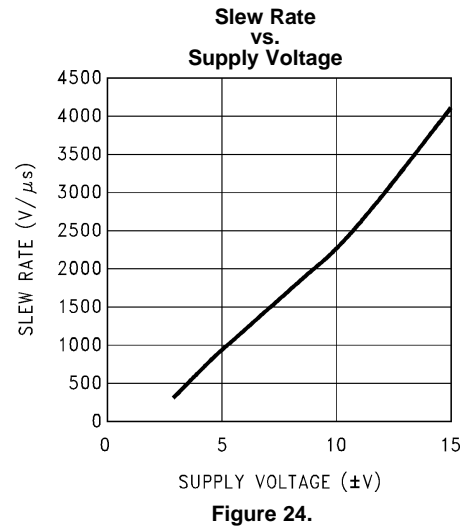
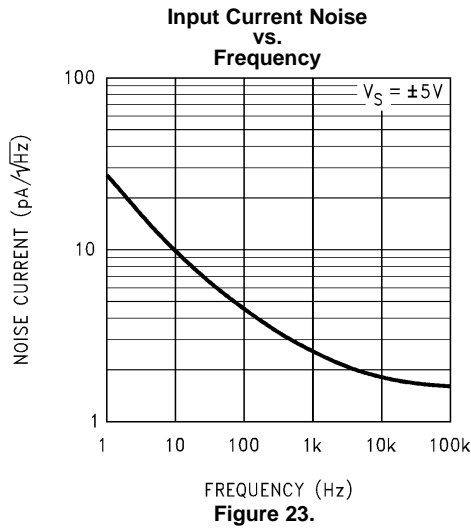
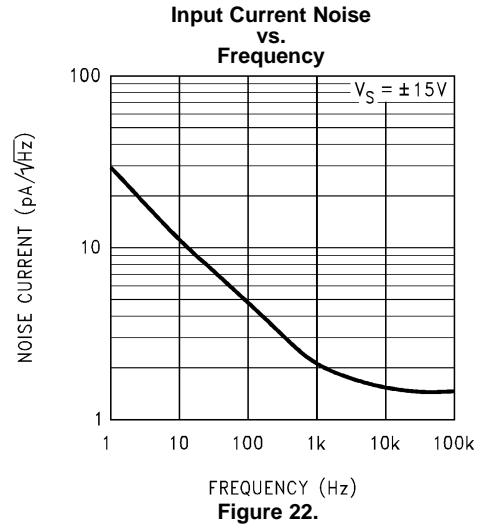
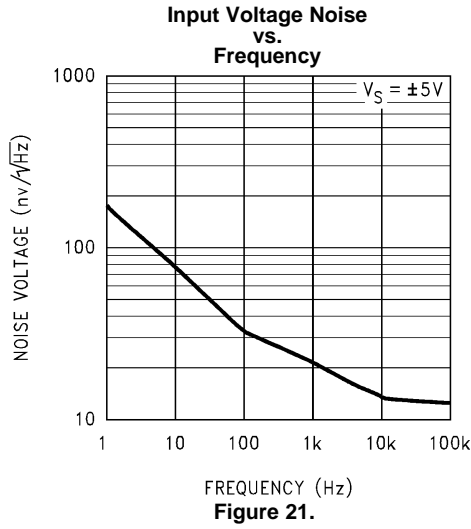

Figure 20.

Typical Performance Characteristics (continued)

unless otherwise noted, $T_A = 25^\circ\text{C}$



Typical Performance Characteristics (continued)

unless otherwise noted, $T_A = 25^\circ\text{C}$

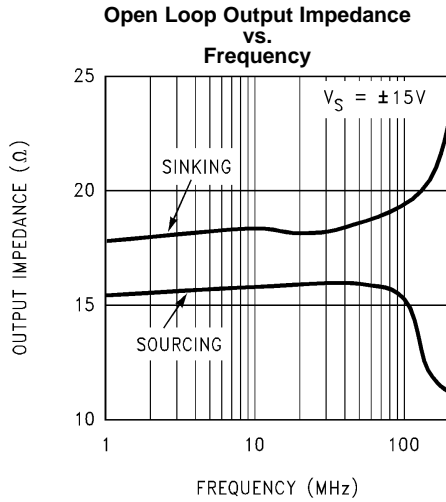

Figure 27.

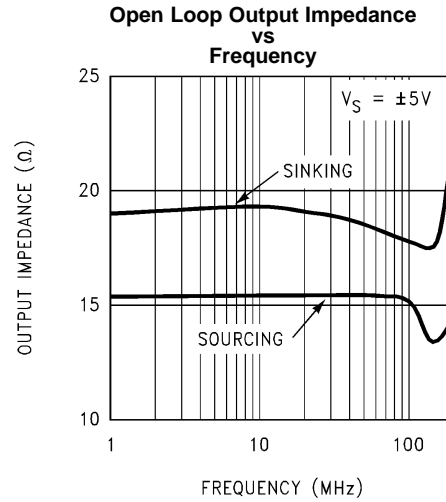

Figure 28.

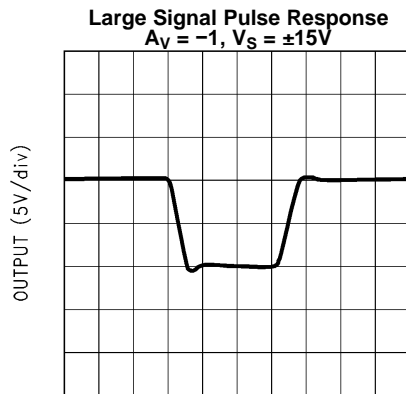

Figure 29.

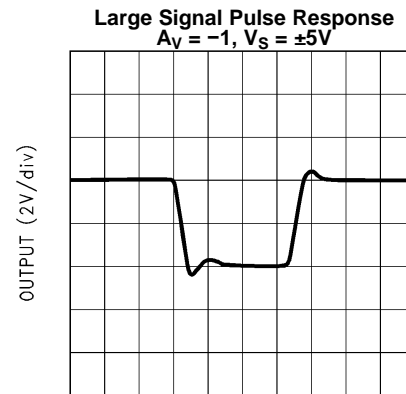

Figure 30.

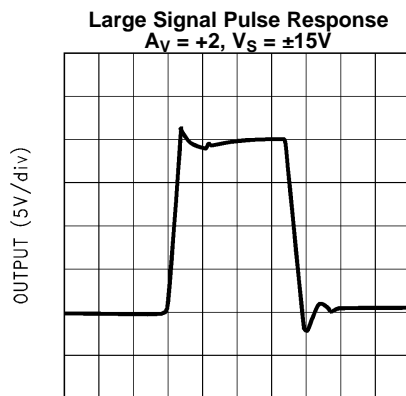

Figure 31.

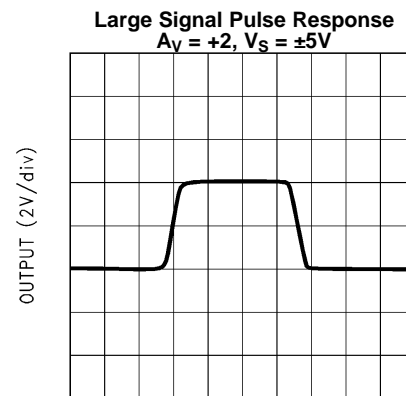
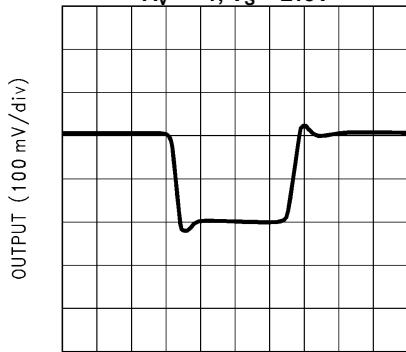

Figure 32.

Typical Performance Characteristics (continued)

unless otherwise noted, $T_A = 25^\circ\text{C}$

Small Signal Pulse Response
 $A_V = -1, V_S = \pm 15\text{V}$



TIME (20 ns/div)
Figure 33.

Small Signal Pulse Response
 $A_V = -1, V_S = \pm 5\text{V}$

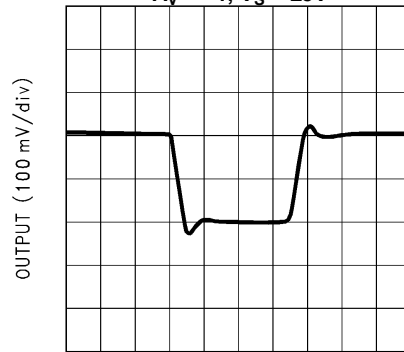

TIME (20 ns/div)
Figure 34.

Small Signal Pulse Response
 $A_V = +2, V_S = \pm 15\text{V}$

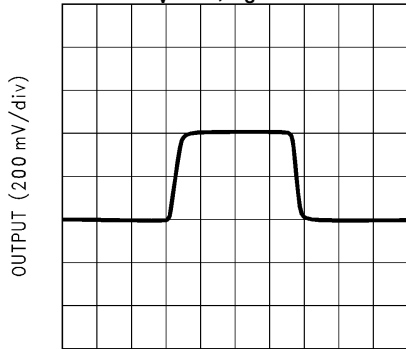

TIME (20 ns/div)
Figure 35.

Small Signal Pulse Response
 $A_V = +2, V_S = \pm 5\text{V}$

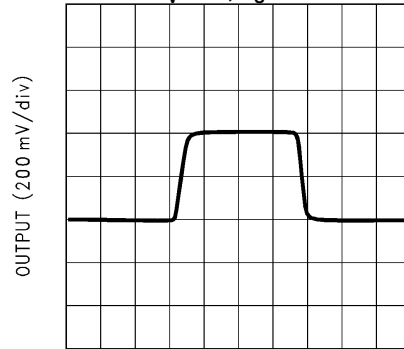

TIME (20 ns/div)
Figure 36.

Closed Loop Frequency Response vs. Supply Voltage
 $(A_V = +2)$

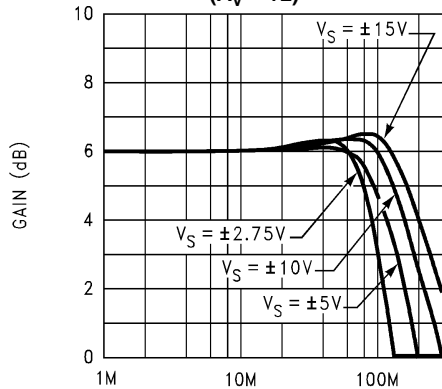

FREQUENCY (Hz)
Figure 37.

Closed Loop Frequency Response vs. Capacitive Load
 $(A_V = +2)$

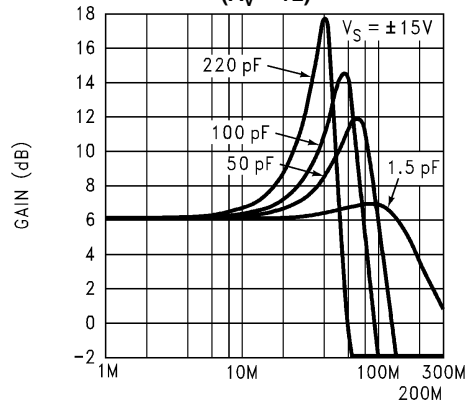

FREQUENCY (Hz)
Figure 38.

Typical Performance Characteristics (continued)

unless otherwise noted, $T_A = 25^\circ\text{C}$

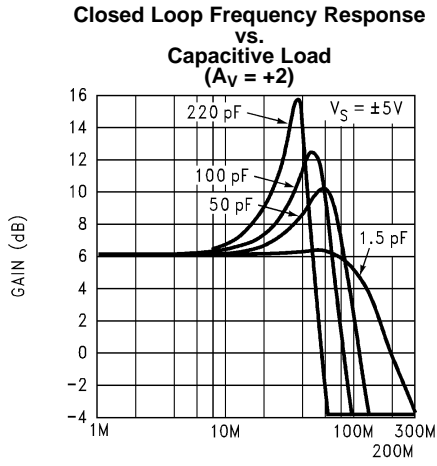

Figure 39.

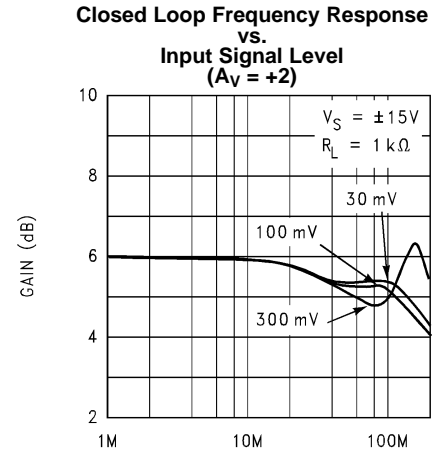

Figure 40.

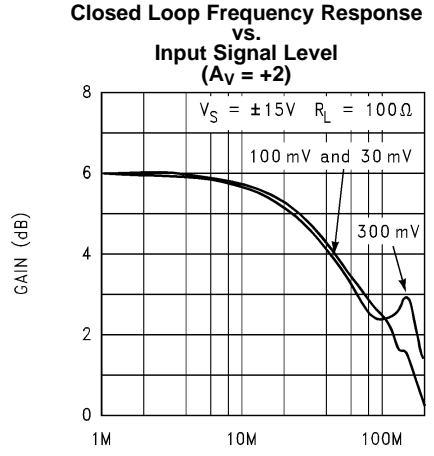

Figure 41.

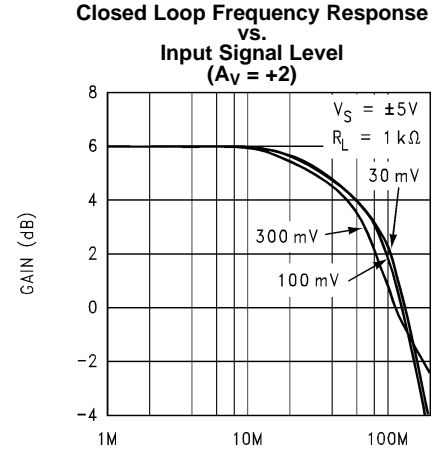

Figure 42.

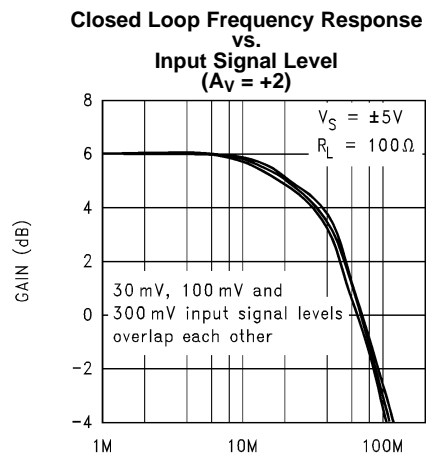

Figure 43.

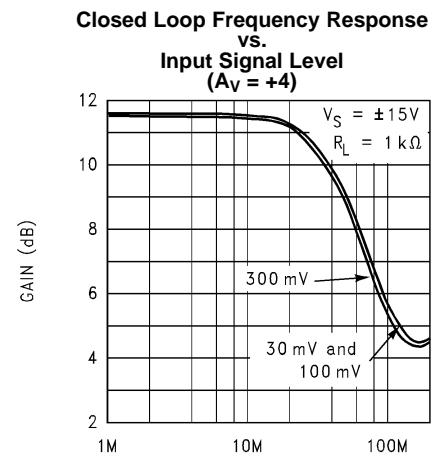

Figure 44.

Typical Performance Characteristics (continued)

unless otherwise noted, $T_A = 25^\circ\text{C}$

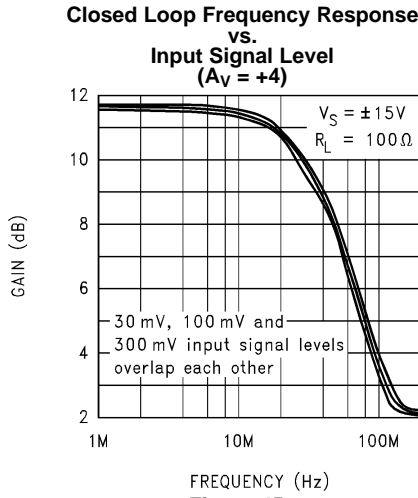

Figure 45.

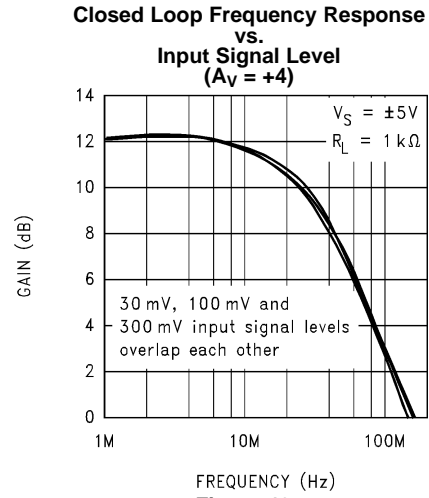

Figure 46.

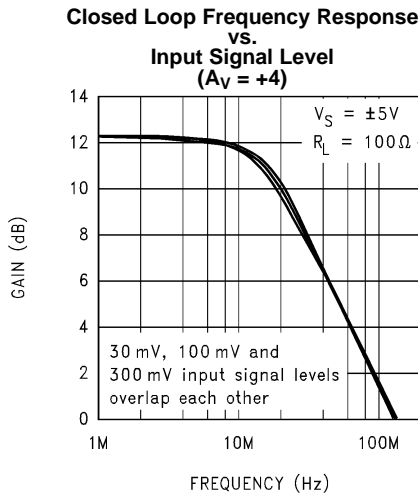

Figure 47.

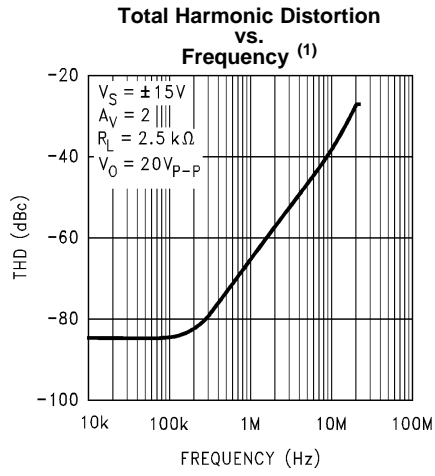

Figure 48.

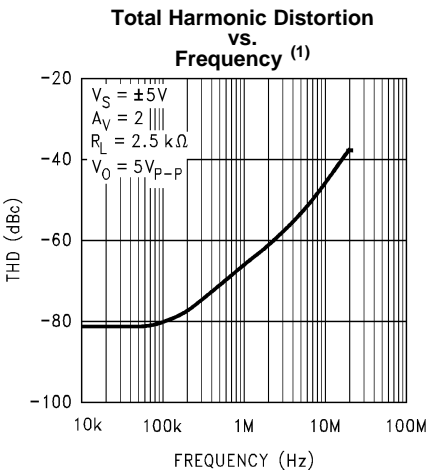

Figure 49.

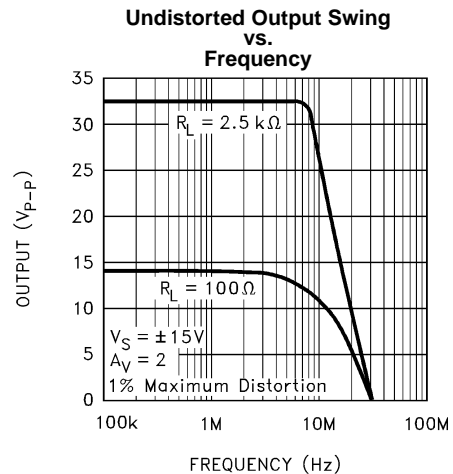

Figure 50.

(1) The THD measurement at low frequency is limited by the test instrument.

Typical Performance Characteristics (continued)

unless otherwise noted, $T_A = 25^\circ\text{C}$

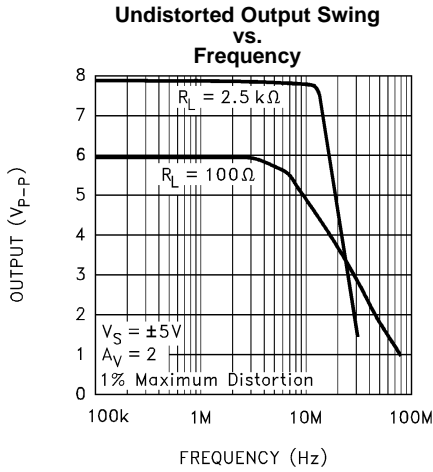

Figure 51.

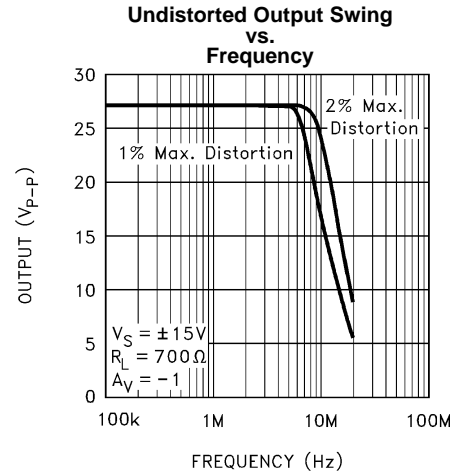

Figure 52.

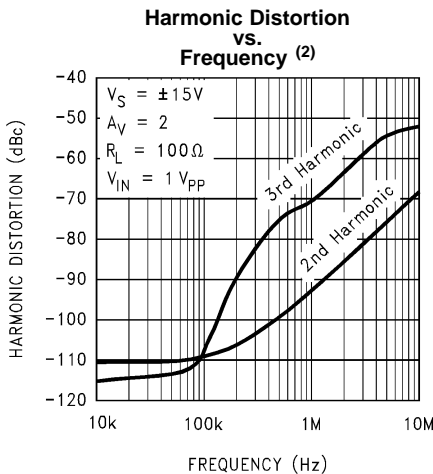

Figure 53.

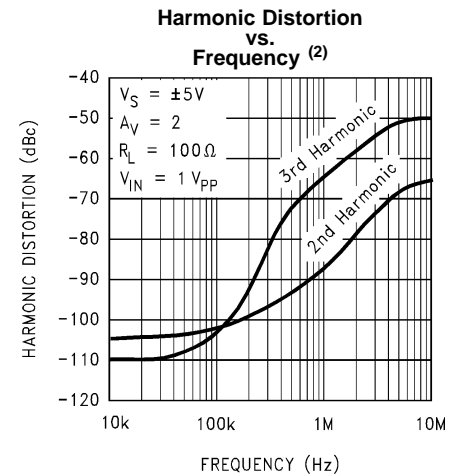

Figure 54.

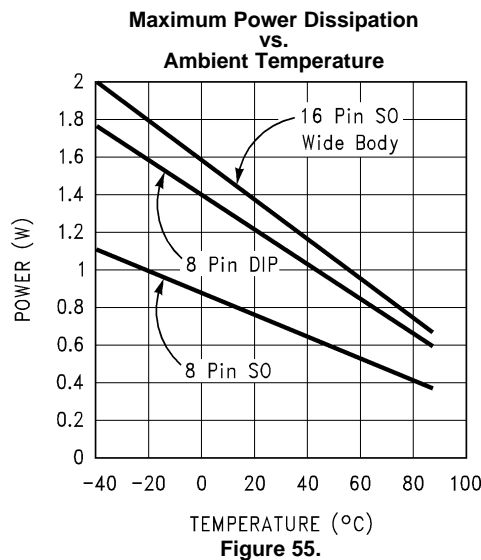
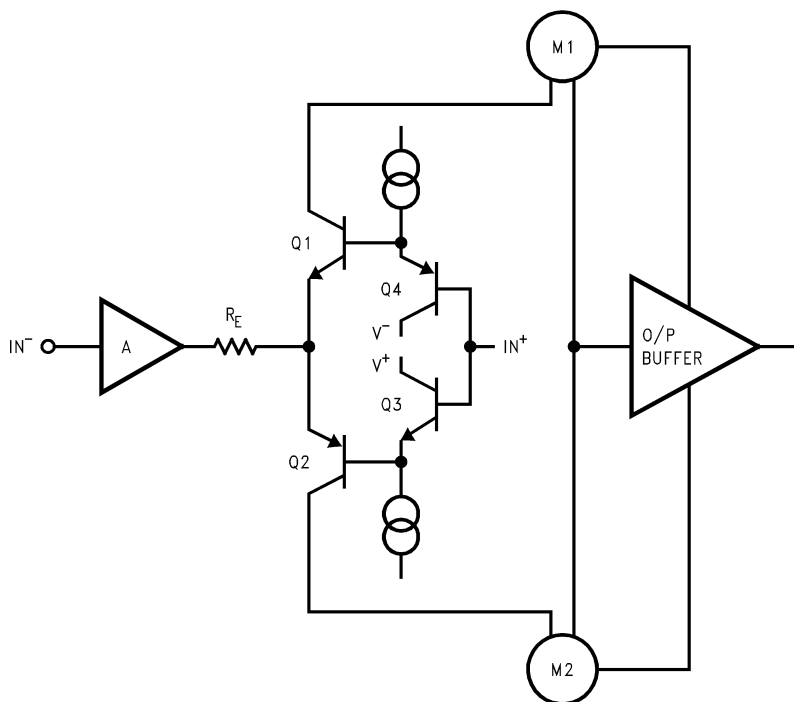

Figure 55.

(2) The THD measurement at low frequency is limited by the test instrument.



Note: M1 and M2 are current mirrors.

Figure 56. Simplified Schematic Diagram

APPLICATION NOTES

PERFORMANCE DISCUSSION

The LM7171 is a very high speed, voltage feedback amplifier. It consumes only 6.5 mA supply current while providing a unity-gain bandwidth of 200 MHz and a slew rate of 4100V/ μ s. It also has other great features such as low differential gain and phase and high output current.

The LM7171 is a true voltage feedback amplifier. Unlike current feedback amplifiers (CFAs) with a low inverting input impedance and a high non-inverting input impedance, both inputs of voltage feedback amplifiers (VFAs) have high impedance nodes. The low impedance inverting input in CFAs and a feedback capacitor create an additional pole that will lead to instability. As a result, CFAs cannot be used in traditional op amp circuits such as photodiode amplifiers, I-to-V converters and integrators where a feedback capacitor is required.

CIRCUIT OPERATION

The class AB input stage in LM7171 is fully symmetrical and has a similar slewing characteristic to the current feedback amplifiers. In the LM7171 Simplified Schematic, Q1 through Q4 form the equivalent of the current feedback input buffer, R_E the equivalent of the feedback resistor, and stage A buffers the inverting input. The triple-buffered output stage isolates the gain stage from the load to provide low output impedance.

SLEW RATE CHARACTERISTIC

The slew rate of LM7171 is determined by the current available to charge and discharge an internal high impedance node capacitor. This current is the differential input voltage divided by the total degeneration resistor R_E . Therefore, the slew rate is proportional to the input voltage level, and the higher slew rates are achievable in the lower gain configurations. A curve of slew rate versus input voltage level is provided in the “Typical Performance Characteristics”.

When a very fast large signal pulse is applied to the input of an amplifier, some overshoot or undershoot occurs. By placing an external resistor such as 1 k Ω in series with the input of LM7171, the bandwidth is reduced to help lower the overshoot.

SLEW RATE LIMITATION

If the amplifier's input signal has too large of an amplitude at too high of a frequency, the amplifier is said to be slew rate limited; this can cause ringing in time domain and peaking in frequency domain at the output of the amplifier.

In the “Typical Performance Characteristics” section, there are several curves of $A_V = +2$ and $A_V = +4$ versus input signal levels. For the $A_V = +4$ curves, no peaking is present and the LM7171 responds identically to the different input signal levels of 30 mV, 100 mV and 300 mV.

For the $A_V = +2$ curves, with slight peaking occurs. This peaking at high frequency (>100 MHz) is caused by a large input signal at high enough frequency that exceeds the amplifier's slew rate. The peaking in frequency response does not limit the pulse response in time domain, and the LM7171 is stable with noise gain of ≥ 2 .

LAYOUT CONSIDERATION

Printed Circuit Board and High Speed Op Amps

There are many things to consider when designing PC boards for high speed op amps. Without proper caution, it is very easy to have excessive ringing, oscillation and other degraded AC performance in high speed circuits. As a rule, the signal traces should be short and wide to provide low inductance and low impedance paths. Any unused board space needs to be grounded to reduce stray signal pickup. Critical components should also be grounded at a common point to eliminate voltage drop. Sockets add capacitance to the board and can affect high frequency performance. It is better to solder the amplifier directly into the PC board without using any socket.

Using Probes

Active (FET) probes are ideal for taking high frequency measurements because they have wide bandwidth, high input impedance and low input capacitance. However, the probe ground leads provide a long ground loop that will produce errors in measurement. Instead, the probes can be grounded directly by removing the ground leads and probe jackets and using scope probe jacks.

Component Selection and Feedback Resistor

It is important in high speed applications to keep all component leads short. For discrete components, choose carbon composition-type resistors and mica-type capacitors. Surface mount components are preferred over discrete components for minimum inductive effect.

Large values of feedback resistors can couple with parasitic capacitance and cause undesirable effects such as ringing or oscillation in high speed amplifiers. For LM7171, a feedback resistor of 510Ω gives optimal performance.

COMPENSATION FOR INPUT CAPACITANCE

The combination of an amplifier's input capacitance with the gain setting resistors adds a pole that can cause peaking or oscillation. To solve this problem, a feedback capacitor with a value

$$C_F > (R_G \times C_{IN})/R_F \quad (1)$$

can be used to cancel that pole. For LM7171, a feedback capacitor of 2 pF is recommended. [Figure 57](#) illustrates the compensation circuit.

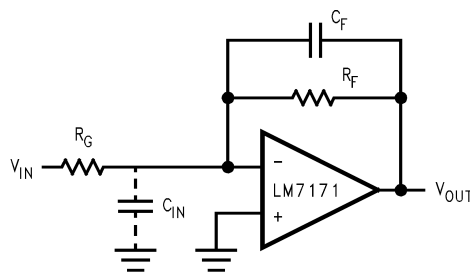

Figure 57. Compensating for Input Capacitance

POWER SUPPLY BYPASSING

Bypassing the power supply is necessary to maintain low power supply impedance across frequency. Both positive and negative power supplies should be bypassed individually by placing 0.01 μF ceramic capacitors directly to power supply pins and 2.2 μF tantalum capacitors close to the power supply pins.

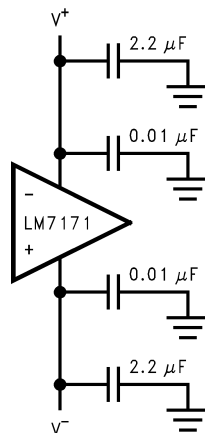

Figure 58. Power Supply Bypassing

TERMINATION

In high frequency applications, reflections occur if signals are not properly terminated. [Figure 59](#) shows a properly terminated signal while [Figure 60](#) shows an improperly terminated signal.

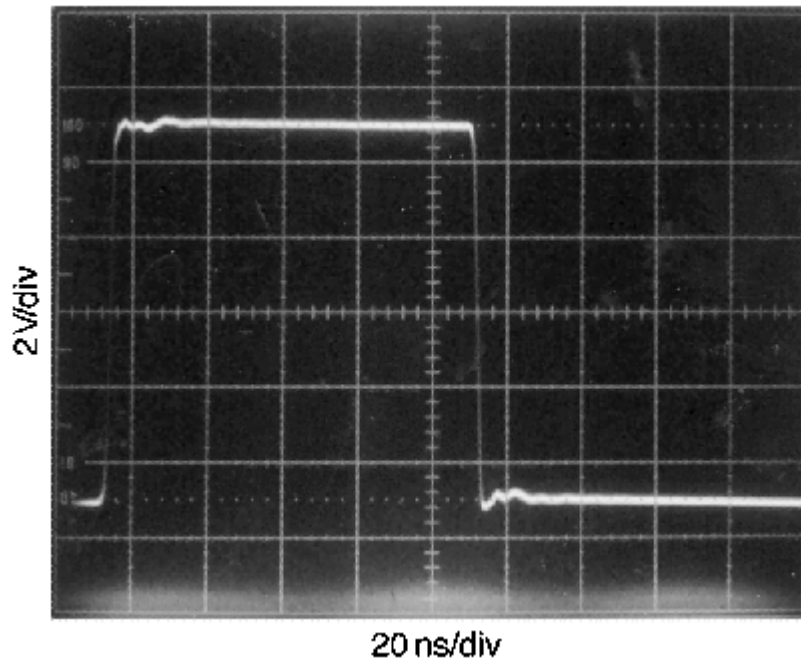

Figure 59. Properly Terminated Signal

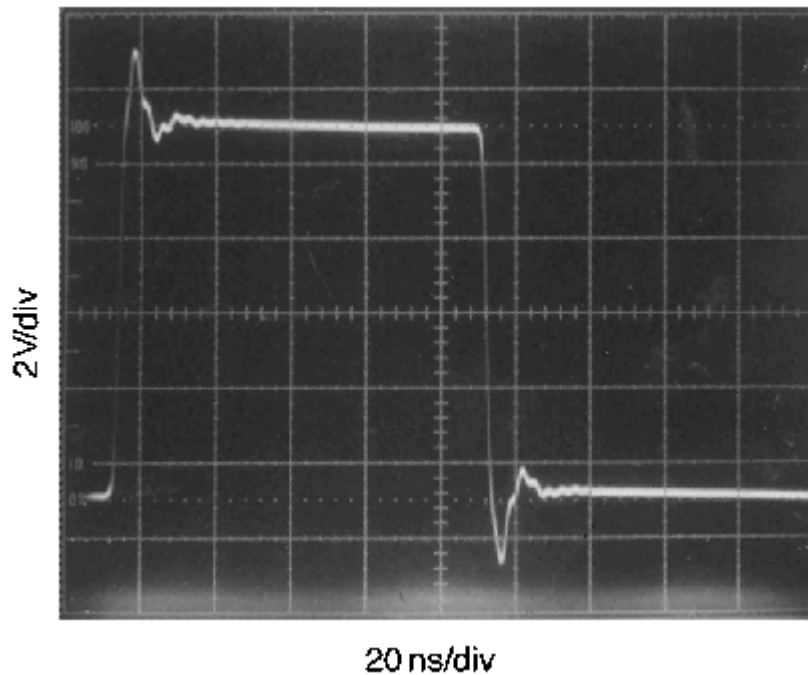

Figure 60. Improperly Terminated Signal

To minimize reflection, coaxial cable with matching characteristic impedance to the signal source should be used. The other end of the cable should be terminated with the same value terminator or resistor. For the commonly used cables, RG59 has 75 Ω characteristic impedance, and RG58 has 50 Ω characteristic impedance.

DRIVING CAPACITIVE LOADS

Amplifiers driving capacitive loads can oscillate or have ringing at the output. To eliminate oscillation or reduce ringing, an isolation resistor can be placed as shown below in Figure 61. The combination of the isolation resistor and the load capacitor forms a pole to increase stability by adding more phase margin to the overall system. The desired performance depends on the value of the isolation resistor; the bigger the isolation resistor, the more damped the pulse response becomes. For LM7171, a 50Ω isolation resistor is recommended for initial evaluation. Figure 62 shows the LM7171 driving a 150 pF load with the 50Ω isolation resistor.

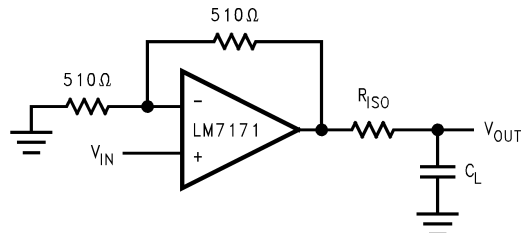

Figure 61. Isolation Resistor Used to Drive Capacitive Load

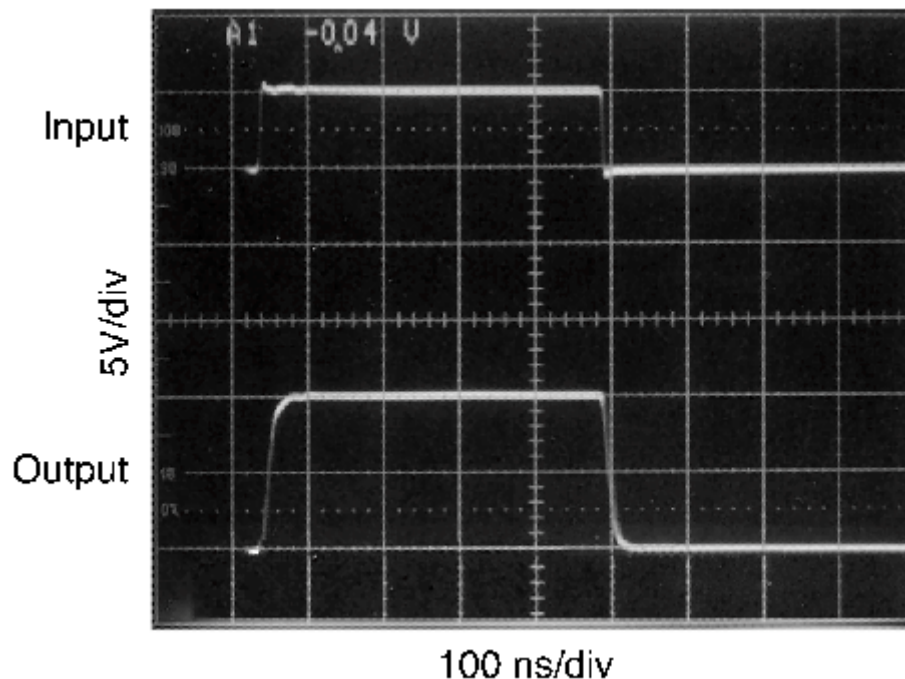

Figure 62. The LM7171 Driving a 150 pF Load with a 50Ω Isolation Resistor

POWER DISSIPATION

The maximum power allowed to dissipate in a device is defined as:

$$P_D = (T_{J(\text{MAX})} - T_A) / \theta_{JA} \quad (2)$$

Where

- PD** is the power dissipation in a device
- T_{J(max)}** is the maximum junction temperature
- T_A** is the ambient temperature
- θ_{JA}** is the thermal resistance of a particular package

For example, for the LM7171 in a SOIC-8 package, the maximum power dissipation at 25°C ambient temperature is 730 mW.

Thermal resistance, θ_{JA} , depends on parameters such as die size, package size and package material. The smaller the die size and package, the higher θ_{JA} becomes. The 8-pin DIP package has a lower thermal resistance (108°C/W) than that of 8-pin SOIC (172°C/W). Therefore, for higher dissipation capability, use an 8-pin DIP package.

The total power dissipated in a device can be calculated as:

$$P_D = P_Q + P_L \quad (3)$$

P_Q is the quiescent power dissipated in a device with no load connected at the output. P_L is the power dissipated in the device with a load connected at the output; it is not the power dissipated by the load.

Furthermore,

P_Q : = supply current \times total supply voltage with no load

P_L : = output current \times (voltage difference between supply voltage and output voltage of the same side of supply voltage)

For example, the total power dissipated by the LM7171 with $V_S = \pm 15V$ and output voltage of 10V into 1 k Ω is

$$\begin{aligned} P_D &= P_Q + P_L \\ &= (6.5 \text{ mA}) \times (30V) + (10 \text{ mA}) \times (15V - 10V) \\ &= 195 \text{ mW} + 50 \text{ mW} \\ &= 245 \text{ mW} \end{aligned}$$

Application Circuit

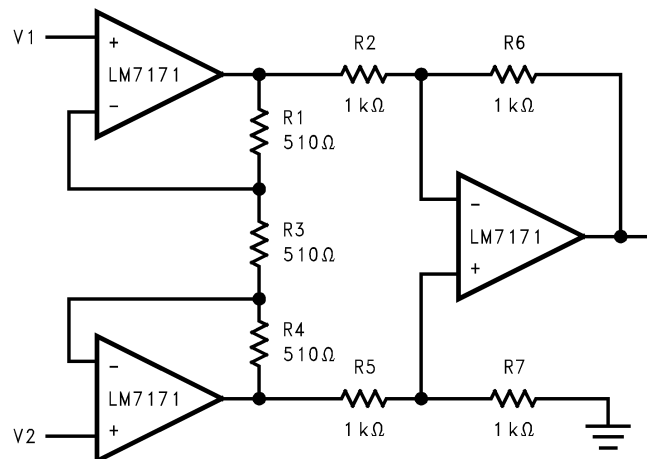

Figure 63. Fast Instrumentation Amplifier

$$\begin{aligned} V_{IN} &= V_2 - V_1 \\ \text{if } R_6 &= R_2, R_7 = R_5, \text{ and } R_1 = R_4 \\ \frac{V_{OUT}}{V_{IN}} &= \frac{R_6}{R_2} \left(1 + 2 \frac{R_1}{R_3} \right) = 3 \end{aligned}$$

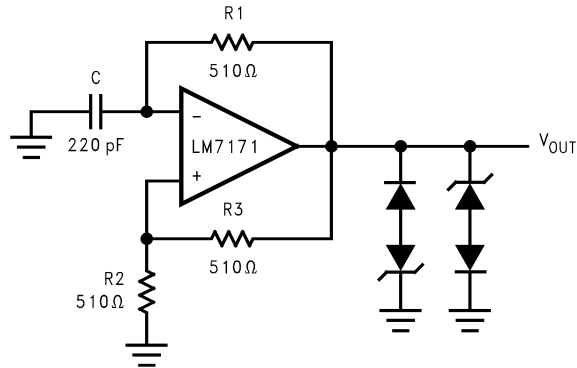

Figure 64. Multivibrator

$$f = \frac{1}{2 \left(R1 C \ln \left(1 + 2 \frac{R2}{R3} \right) \right)}$$

$$f = 4 \text{ MHz}$$

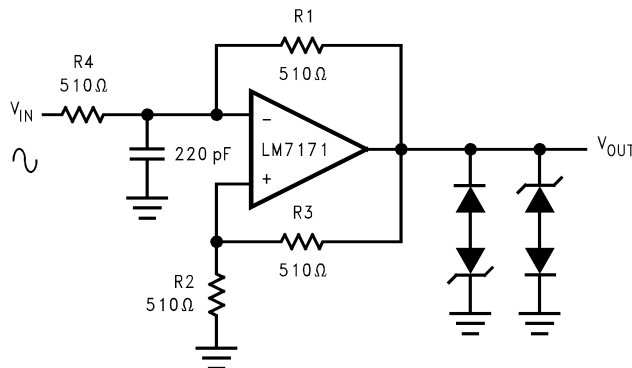

Figure 65. Pulse Width Modulator

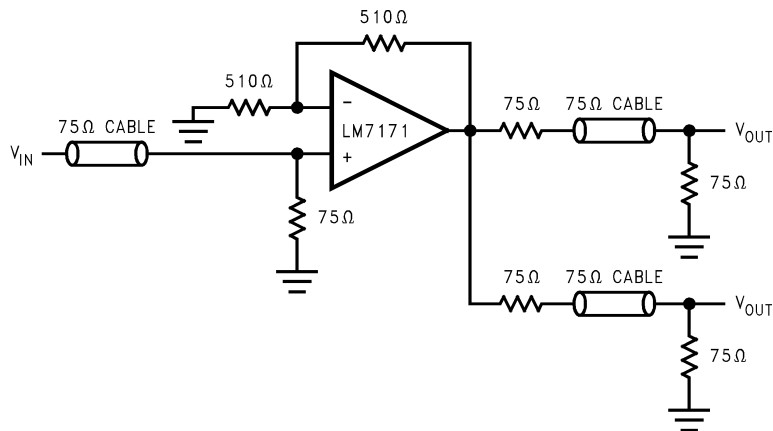

Figure 66. Video Line Driver

REVISION HISTORY

Changes from Revision A (March 2013) to Revision B	Page
<hr/> <ul style="list-style-type: none">• Changed layout of National Data Sheet to TI format	22

PACKAGING INFORMATION

Orderable Device	Status (1)	Package Type	Package Drawing	Pins	Package Qty	Eco Plan (2)	Lead/Ball Finish (6)	MSL Peak Temp (3)	Op Temp (°C)	Device Marking (4/5)	Samples
LM7171AIM	NRND	SOIC	D	8	95	TBD	Call TI	Call TI	-40 to 85	LM71 71AIM	
LM7171AIM/NOPB	ACTIVE	SOIC	D	8	95	Green (RoHS & no Sb/Br)	SN CU SN	Level-1-260C-UNLIM	-40 to 85	LM71 71AIM	Samples
LM7171AIMX	NRND	SOIC	D	8	2500	TBD	Call TI	Call TI	-40 to 85	LM71 71AIM	
LM7171AIMX/NOPB	ACTIVE	SOIC	D	8	2500	Green (RoHS & no Sb/Br)	SN CU SN	Level-1-260C-UNLIM	-40 to 85	LM71 71AIM	Samples
LM7171BIM	NRND	SOIC	D	8	95	TBD	Call TI	Call TI	-40 to 85	LM71 71BIM	
LM7171BIM/NOPB	ACTIVE	SOIC	D	8	95	Green (RoHS & no Sb/Br)	SN CU SN	Level-1-260C-UNLIM	-40 to 85	LM71 71BIM	Samples
LM7171BIMX/NOPB	ACTIVE	SOIC	D	8	2500	Green (RoHS & no Sb/Br)	SN CU SN	Level-1-260C-UNLIM	-40 to 85	LM71 71BIM	Samples
LM7171BIN	NRND	PDIP	P	8	40	TBD	Call TI	Call TI	-40 to 85	LM7171 BIN	
LM7171BIN/NOPB	ACTIVE	PDIP	P	8	40	Green (RoHS & no Sb/Br)	CU SN	Level-1-NA-UNLIM	-40 to 85	LM7171 BIN	Samples

(1) The marketing status values are defined as follows:

ACTIVE: Product device recommended for new designs.

LIFEBUY: TI has announced that the device will be discontinued, and a lifetime-buy period is in effect.

NRND: Not recommended for new designs. Device is in production to support existing customers, but TI does not recommend using this part in a new design.

PREVIEW: Device has been announced but is not in production. Samples may or may not be available.

OBSELETE: TI has discontinued the production of the device.

(2) Eco Plan - The planned eco-friendly classification: Pb-Free (RoHS), Pb-Free (RoHS Exempt), or Green (RoHS & no Sb/Br) - please check <http://www.ti.com/productcontent> for the latest availability information and additional product content details.

TBD: The Pb-Free/Green conversion plan has not been defined.

Pb-Free (RoHS): TI's terms "Lead-Free" or "Pb-Free" mean semiconductor products that are compatible with the current RoHS requirements for all 6 substances, including the requirement that lead not exceed 0.1% by weight in homogeneous materials. Where designed to be soldered at high temperatures, TI Pb-Free products are suitable for use in specified lead-free processes.

Pb-Free (RoHS Exempt): This component has a RoHS exemption for either 1) lead-based flip-chip solder bumps used between the die and package, or 2) lead-based die adhesive used between the die and leadframe. The component is otherwise considered Pb-Free (RoHS compatible) as defined above.

Green (RoHS & no Sb/Br): TI defines "Green" to mean Pb-Free (RoHS compatible), and free of Bromine (Br) and Antimony (Sb) based flame retardants (Br or Sb do not exceed 0.1% by weight in homogeneous material)

- (3) MSL, Peak Temp. - The Moisture Sensitivity Level rating according to the JEDEC industry standard classifications, and peak solder temperature.
- (4) There may be additional marking, which relates to the logo, the lot trace code information, or the environmental category on the device.
- (5) Multiple Device Markings will be inside parentheses. Only one Device Marking contained in parentheses and separated by a "~" will appear on a device. If a line is indented then it is a continuation of the previous line and the two combined represent the entire Device Marking for that device.
- (6) Lead/Ball Finish - Orderable Devices may have multiple material finish options. Finish options are separated by a vertical ruled line. Lead/Ball Finish values may wrap to two lines if the finish value exceeds the maximum column width.

Important Information and Disclaimer:The information provided on this page represents TI's knowledge and belief as of the date that it is provided. TI bases its knowledge and belief on information provided by third parties, and makes no representation or warranty as to the accuracy of such information. Efforts are underway to better integrate information from third parties. TI has taken and continues to take reasonable steps to provide representative and accurate information but may not have conducted destructive testing or chemical analysis on incoming materials and chemicals. TI and TI suppliers consider certain information to be proprietary, and thus CAS numbers and other limited information may not be available for release.

In no event shall TI's liability arising out of such information exceed the total purchase price of the TI part(s) at issue in this document sold by TI to Customer on an annual basis.

TAPE AND REEL INFORMATION



QUADRANT ASSIGNMENTS FOR PIN 1 ORIENTATION IN TAPE



*All dimensions are nominal

Device	Package Type	Package Drawing	Pins	SPQ	Reel Diameter (mm)	Reel Width W1 (mm)	A0 (mm)	B0 (mm)	K0 (mm)	P1 (mm)	W (mm)	Pin1 Quadrant
LM7171AIMX	SOIC	D	8	2500	330.0	12.4	6.5	5.4	2.0	8.0	12.0	Q1
LM7171AIMX/NOPB	SOIC	D	8	2500	330.0	12.4	6.5	5.4	2.0	8.0	12.0	Q1
LM7171BIMX/NOPB	SOIC	D	8	2500	330.0	12.4	6.5	5.4	2.0	8.0	12.0	Q1

TAPE AND REEL BOX DIMENSIONS

*All dimensions are nominal

Device	Package Type	Package Drawing	Pins	SPQ	Length (mm)	Width (mm)	Height (mm)
LM7171AIMX	SOIC	D	8	2500	367.0	367.0	35.0
LM7171AIMX/NOPB	SOIC	D	8	2500	367.0	367.0	35.0
LM7171BIMX/NOPB	SOIC	D	8	2500	367.0	367.0	35.0

P (R-PDIP-T8)

PLASTIC DUAL-IN-LINE PACKAGE

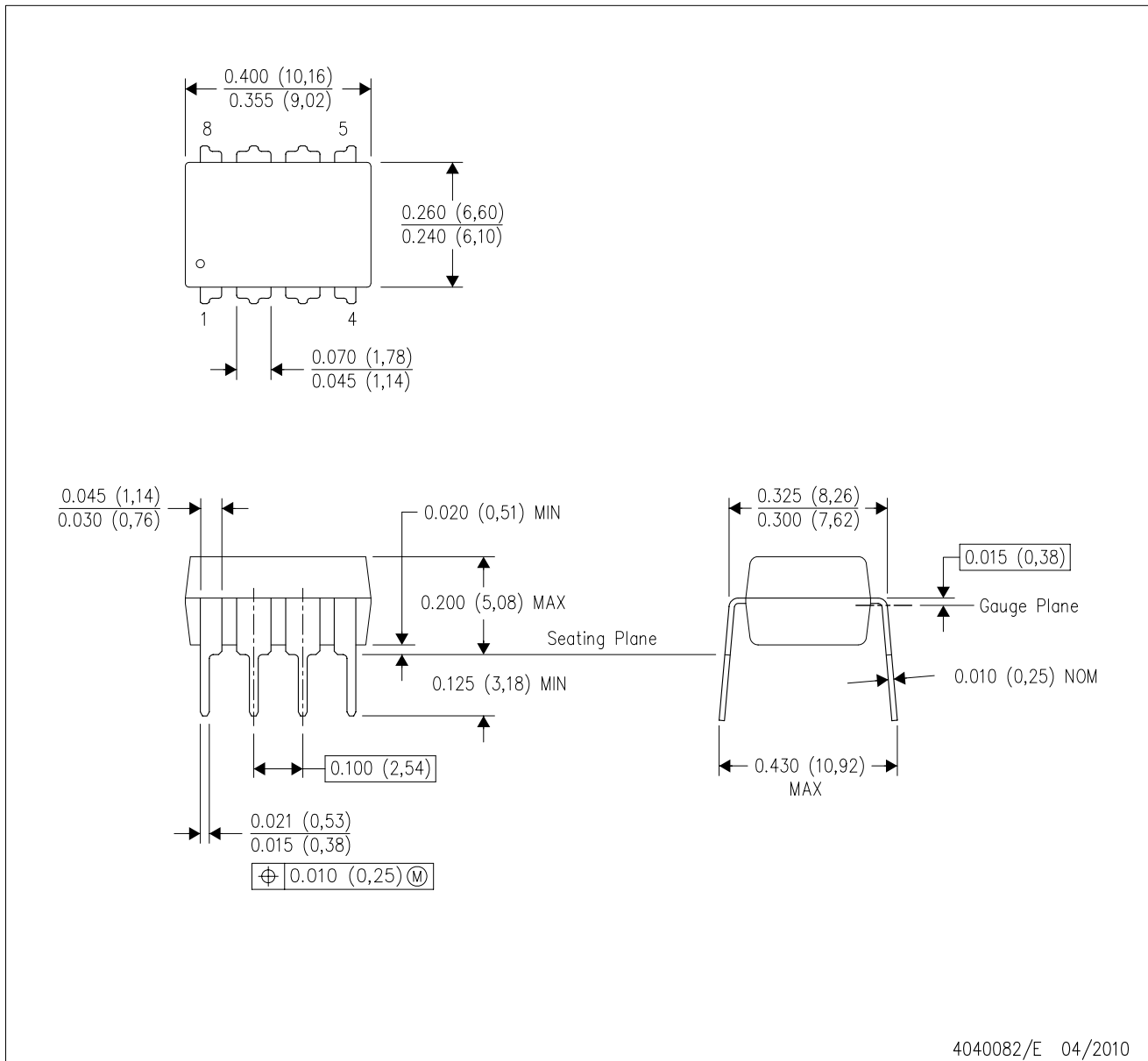

- NOTES:
- A. All linear dimensions are in inches (millimeters).
 - B. This drawing is subject to change without notice.
 - C. Falls within JEDEC MS-001 variation BA.

D (R-PDSO-G8)

PLASTIC SMALL OUTLINE

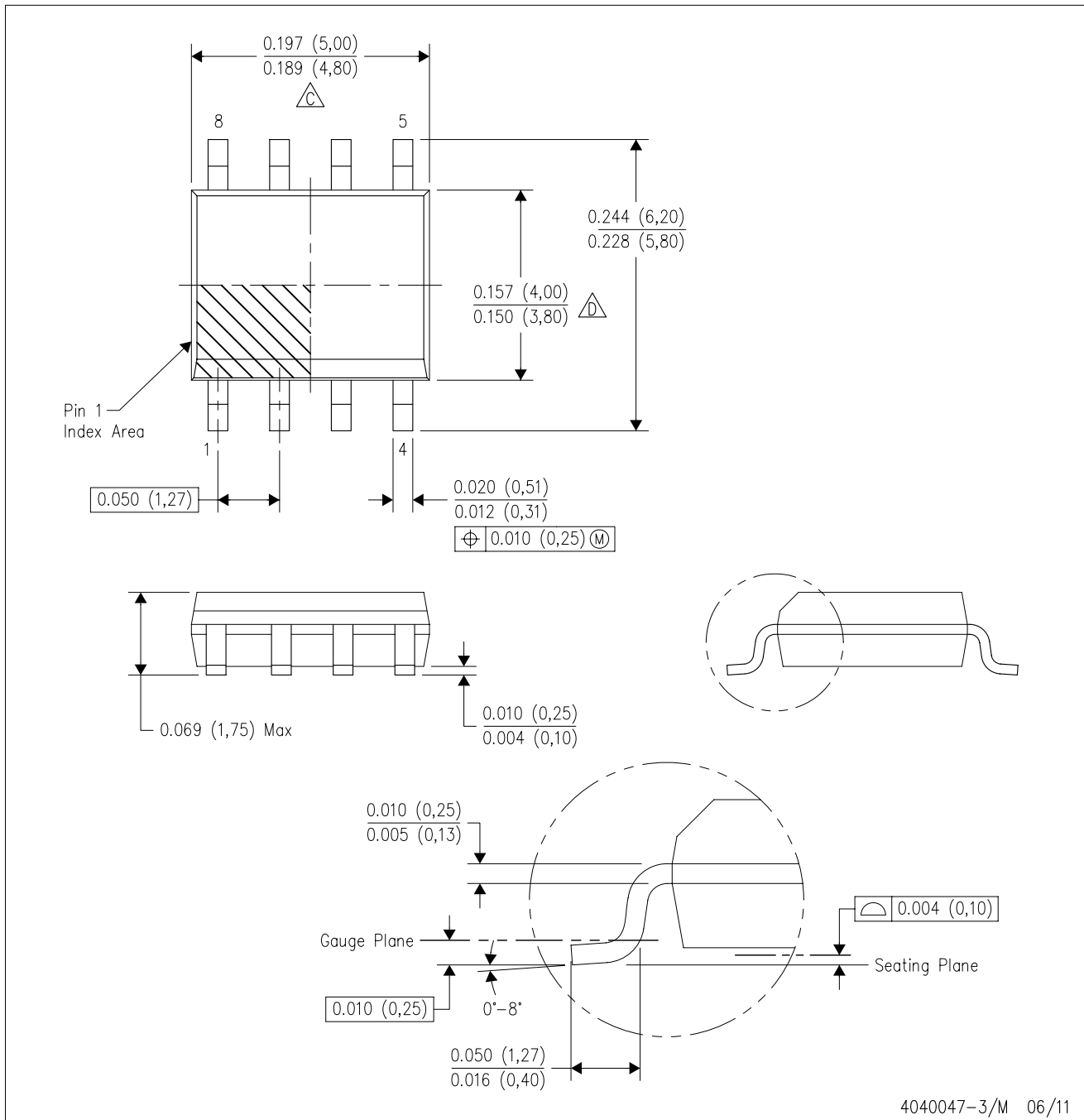

- NOTES:
- A. All linear dimensions are in inches (millimeters).
 - B. This drawing is subject to change without notice.
 - $\triangle C$ Body length does not include mold flash, protrusions, or gate burrs. Mold flash, protrusions, or gate burrs shall not exceed 0.006 (0,15) each side.
 - $\triangle D$ Body width does not include interlead flash. Interlead flash shall not exceed 0.017 (0,43) each side.
 - E. Reference JEDEC MS-012 variation AA.

IMPORTANT NOTICE

Texas Instruments Incorporated and its subsidiaries (TI) reserve the right to make corrections, enhancements, improvements and other changes to its semiconductor products and services per JESD46, latest issue, and to discontinue any product or service per JESD48, latest issue. Buyers should obtain the latest relevant information before placing orders and should verify that such information is current and complete. All semiconductor products (also referred to herein as "components") are sold subject to TI's terms and conditions of sale supplied at the time of order acknowledgment.

TI warrants performance of its components to the specifications applicable at the time of sale, in accordance with the warranty in TI's terms and conditions of sale of semiconductor products. Testing and other quality control techniques are used to the extent TI deems necessary to support this warranty. Except where mandated by applicable law, testing of all parameters of each component is not necessarily performed.

TI assumes no liability for applications assistance or the design of Buyers' products. Buyers are responsible for their products and applications using TI components. To minimize the risks associated with Buyers' products and applications, Buyers should provide adequate design and operating safeguards.

TI does not warrant or represent that any license, either express or implied, is granted under any patent right, copyright, mask work right, or other intellectual property right relating to any combination, machine, or process in which TI components or services are used. Information published by TI regarding third-party products or services does not constitute a license to use such products or services or a warranty or endorsement thereof. Use of such information may require a license from a third party under the patents or other intellectual property of the third party, or a license from TI under the patents or other intellectual property of TI.

Reproduction of significant portions of TI information in TI data books or data sheets is permissible only if reproduction is without alteration and is accompanied by all associated warranties, conditions, limitations, and notices. TI is not responsible or liable for such altered documentation. Information of third parties may be subject to additional restrictions.

Resale of TI components or services with statements different from or beyond the parameters stated by TI for that component or service voids all express and any implied warranties for the associated TI component or service and is an unfair and deceptive business practice. TI is not responsible or liable for any such statements.

Buyer acknowledges and agrees that it is solely responsible for compliance with all legal, regulatory and safety-related requirements concerning its products, and any use of TI components in its applications, notwithstanding any applications-related information or support that may be provided by TI. Buyer represents and agrees that it has all the necessary expertise to create and implement safeguards which anticipate dangerous consequences of failures, monitor failures and their consequences, lessen the likelihood of failures that might cause harm and take appropriate remedial actions. Buyer will fully indemnify TI and its representatives against any damages arising out of the use of any TI components in safety-critical applications.

In some cases, TI components may be promoted specifically to facilitate safety-related applications. With such components, TI's goal is to help enable customers to design and create their own end-product solutions that meet applicable functional safety standards and requirements. Nonetheless, such components are subject to these terms.

No TI components are authorized for use in FDA Class III (or similar life-critical medical equipment) unless authorized officers of the parties have executed a special agreement specifically governing such use.

Only those TI components which TI has specifically designated as military grade or "enhanced plastic" are designed and intended for use in military/aerospace applications or environments. Buyer acknowledges and agrees that any military or aerospace use of TI components which have **not** been so designated is solely at the Buyer's risk, and that Buyer is solely responsible for compliance with all legal and regulatory requirements in connection with such use.

TI has specifically designated certain components as meeting ISO/TS16949 requirements, mainly for automotive use. In any case of use of non-designated products, TI will not be responsible for any failure to meet ISO/TS16949.

Products

Audio	www.ti.com/audio
Amplifiers	amplifier.ti.com
Data Converters	dataconverter.ti.com
DLP® Products	www.dlp.com
DSP	dsp.ti.com
Clocks and Timers	www.ti.com/clocks
Interface	interface.ti.com
Logic	logic.ti.com
Power Mgmt	power.ti.com
Microcontrollers	microcontroller.ti.com
RFID	www.ti-rfid.com
OMAP Applications Processors	www.ti.com/omap
Wireless Connectivity	www.ti.com/wirelessconnectivity

Applications

Automotive and Transportation	www.ti.com/automotive
Communications and Telecom	www.ti.com/communications
Computers and Peripherals	www.ti.com/computers
Consumer Electronics	www.ti.com/consumer-apps
Energy and Lighting	www.ti.com/energy
Industrial	www.ti.com/industrial
Medical	www.ti.com/medical
Security	www.ti.com/security
Space, Avionics and Defense	www.ti.com/space-avionics-defense
Video and Imaging	www.ti.com/video

TI E2E Community

e2e.ti.com