

CMOS Quad Bilateral Switch

For Transmission or Multiplexing of Analog or Digital Signals

High-Voltage Types (20-Volt Rating)

■ CD4016B Series types are quad bilateral switches intended for the transmission or multiplexing of analog or digital signals. Each of the four independent bilateral switches has a single control signal input which simultaneously biases both the p and n device in a given switch on or off.

The CD4016 "B" Series types are supplied in 14-lead hermetic dual-in-line ceramic packages (F3A suffix), 14-lead dual-in-line plastic packages (E suffix), 14-lead small-outline packages (M, MT, M96, and NSR suffixes), and 14-lead thin shrink small-outline packages (PW and PWR suffixes).

Features:

- 20-V digital or ± 10 -V peak-to-peak switching
- 280- Ω typical on-state resistance for 15-V operation
- Switch on-state resistance matched to within 10 Ω typ. over 15-V signal-input range
- High on/off output-voltage ratio: 65 dB typ. @ $f_{is} = 10$ kHz, $R_L = 10$ k Ω
- High degree of linearity: <0.5% distortion typ. @ $f_{is} = 1$ kHz, $V_{is} = 5$ V_{p-p}, $V_{DD} - V_{SS} \geq 10$ V, $R_L = 10$ k Ω
- Extremely low off-state leakage resulting in very low offset current and high effective off-state resistance: 100 pA typ. @ $V_{DD} - V_{SS} = 18$ V, $T_A = 25^\circ\text{C}$
- Extremely high control input impedance (control circuit isolated from signal circuit): 1012 Ω typ.
- Low crosstalk between switches: -50 dB typ. @ $f_{is} = 0.9$ MHz, $R_L = 1$ k Ω
- Matched control-input to signal-output capacitance: Reduces output signal transients
- Frequency response, switch on = 40 MHz (typ.)
- 100% tested for quiescent current at 20 V
- Maximum control input current of 1 μA at 18 V over full package temperature range; 100 nA at 18 V at 25 $^\circ\text{C}$
- 5-V, 10-V, and 15-V parametric ratings

Applications:

- Analog signal switching/multiplexing
 - Signal gating ■ Modulator
 - Squelch control ■ Demodulator
 - Chopper ■ Commutating switch
- Digital signal switching/multiplexing
- CMOS logic implementation
- Analog-to-digital & digital-to-analog conversion
- Digital control of frequency, impedance, phase, and analog-signal gain

Terminal Assignment

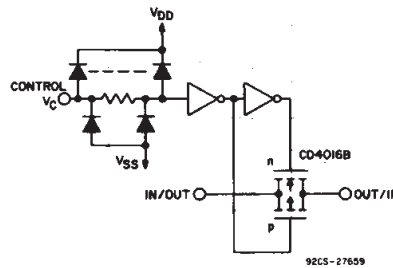
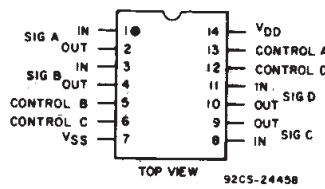

Schematic diagram - 1 of 4 identical sections.

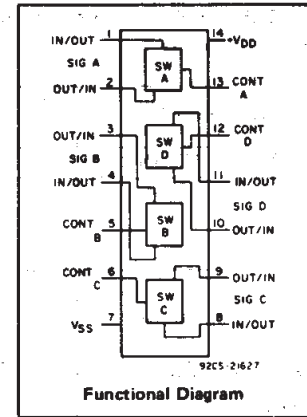

RECOMMENDED OPERATING CONDITIONS

For maximum reliability, nominal operating conditions should be selected so that operation is always within the following range:

CHARACTERISTIC	LIMITS		UNITS
	Min.	Max.	
Supply Voltage Range (For $T_A =$ Full Package Temperature Range)	3	18	V

MAXIMUM RATINGS, Absolute-Maximum Values:

- DC SUPPLY-VOLTAGE RANGE, (V_{DD}) Voltages referenced to V_{SS} Terminal) -0.5V to +20V
- INPUT VOLTAGE RANGE, ALL INPUTS -0.5V to $V_{DD} + 0.5$ V
- DC INPUT CURRENT, ANY ONE INPUT ± 10 mA
- POWER DISSIPATION PER PACKAGE (P_D):
 - For $T_A = -55^\circ\text{C}$ to $+100^\circ\text{C}$ 500mW
 - For $T_A = +100^\circ\text{C}$ to $+125^\circ\text{C}$ Derate Linearly at 12mW/ $^\circ\text{C}$ to 200mW
- DEVICE DISSIPATION PER OUTPUT TRANSISTOR
 - FOR $T_A =$ FULL PACKAGE-TEMPERATURE RANGE (All Package Types) 100mW
- OPERATING-TEMPERATURE RANGE (T_A) -55°C to $+125^\circ\text{C}$
- STORAGE TEMPERATURE RANGE (T_{stg}) -65°C to $+150^\circ\text{C}$
- LEAD TEMPERATURE (DURING SOLDERING):
 - At distance $1/16 \pm 1/32$ inch (1.59 \pm 0.79mm) from case for 10s max $+265^\circ\text{C}$

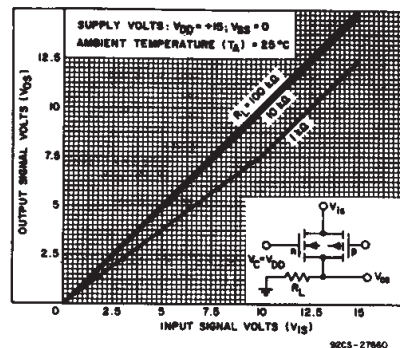

Fig. 1— Typ. on-state characteristics for 1 of 4 switches with $V_{DD} = +15$ V, $V_{SS} = 0$ V.

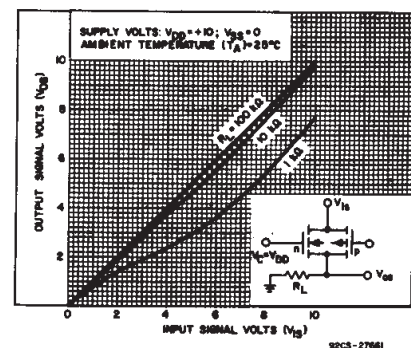

Fig. 2— Typ. on-state characteristics for 1 of 4 switches with $V_{DD} = +10$ V, $V_{SS} = 0$ V.

CD4016B Types

ELECTRICAL CHARACTERISTICS

CHARACTERISTIC	TEST CONDITIONS	LIMITS AT INDICATED TEMPERATURES (°C)							UNITS	
		V _{IN} (V)	V _{DD} (V)					+25		
				-55	-40	+85	+125	Typ.		Max.
Quiescent Device Current, I _{DD}		0,5	5	0,25	0,25	7,5	7,5	0,01	0,25	μA
		0,10	10	0,5	0,5	15	15	0,01	0,5	
		0,15	15	1	1	30	30	0,01	1	
		0,20	20	5	5	150	150	0,02	5	
Signal Inputs (V _{is}) and Output (V _{os})										
On-State Resistance, r _{on} Max.	V _C = V _{DD} R _L = 10 kΩ Returned to V _{DD} - V _{SS} 2	V _{is} = V _{DD} or V _{SS}	10	600	610	840	960	-	660	Ω
		V _{is} = 4.75 to 5.75 V	10	1870	1900	2380	2600	-	2000	
Δ On-State Resistance Between Any 2 Switches, Δr _{on}	R _L = 10 kΩ, V _C = V _{DD}	V _{is} = V _{DD} or V _{SS}	15	360	370	520	600	-	400	Ω
		V _{is} = 7.25 to 7.75 V	15	775	790	1080	1230	-	850	
Total Harmonic Distortion, THD	V _C = V _{DD} = 5 V, V _{SS} = -5 V, V _{is} (p-p) = 5 V (Sine wave centered on 0 V) R _L = 10 kΩ, f _{is} = 1 kHz sine wave		-	-	-	-	0.4	-	%	
-3dB Cutoff Frequency (Switch on)	V _C = V _{DD} = 5 V, V _{SS} = -5 V, V _{is} (p-p) = 5 V (Sine wave centered on 0 V) R _L = 1 kΩ.		-	-	-	-	40	-	MHz	
-50dB Feed-through Frequency (Switch off)	V _C = V _{SS} = -5 V, V _{is} (p-p) = 5 V (Sine wave centered on 0 V) R _L = 1 kΩ		-	-	-	-	1.25	-	MHz	
Input/Output Leakage Current (Switch off) I _{is} Max.	V _C = 0 V V _{is} = 18 V, V _{os} = 0 V; V _{is} = 0 V, V _{os} = 18 V	18	±0.1	±0.1	±1	±1	10 ⁻⁴	±0.1	μA	
-50 dB Crosstalk Frequency	V _C (A) = V _{DD} = +5 V, V _C (B) = V _{SS} = -5 V, V _{is} (A) = 5 V p-p, 50 Ω source R _L = 1 kΩ		-	-	-	-	0.9	-	MHz	
Propagation Delay (Signal Input to Signal Output) t _{pd}	R _L = 200 kΩ V _C = V _{DD} , V _{SS} = GND, C _L = 50 pF V _{is} = Square Wave 0 to V _{DD} t _r , t _f = 20 ns	5	-	-	-	-	40	100	ns	
		10	-	-	-	-	20	40		
		15	-	-	-	-	15	30		
Capacitance: Input, C _{is} Output, C _{os} Feedthrough, C _{ios}	V _{DD} = +5 V V _C = V _{SS} = -5 V		-	-	-	-	4	-	pF	
			-	-	-	-	4	-		
			-	-	-	-	0.2	-		

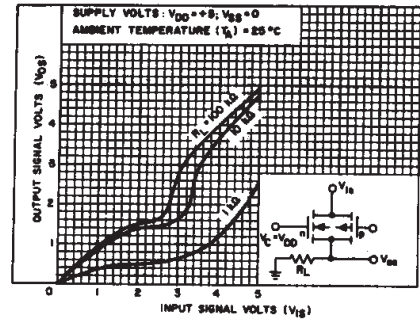

Fig. 3—Typ. on-state characteristics for 1 of 4 switches with V_{DD} = +5 V, V_{SS} = 0 V.

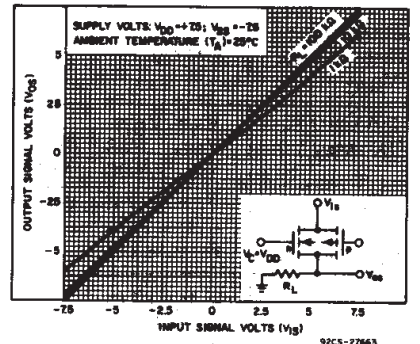

Fig. 4—Typ. on-state characteristics for 1 of 4 switches with V_{DD} = +7.5 V, V_{SS} = -7.5 V.

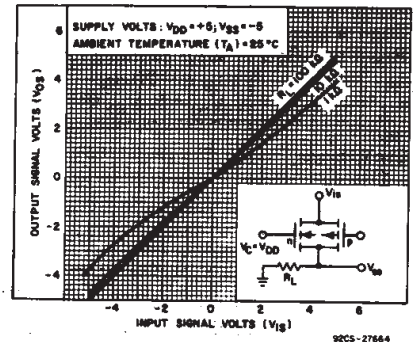

Fig. 5—Typ. on-state characteristics for 1 of 4 switches with V_{DD} = +5 V, V_{SS} = -5 V.

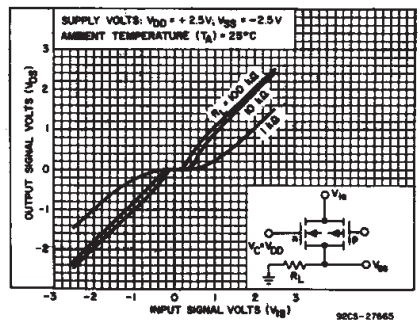

Fig. 6—Typ. on-state characteristics for 1 of 4 switches with V_{DD} = +2.5 V, V_{SS} = -2.5 V.

3
COMMERCIAL CMOS
HIGH VOLTAGE ICs

CD4016B Types

ELECTRICAL CHARACTERISTICS (cont'd)

CHARACTERISTIC	TEST CONDITIONS	LIMITS AT INDICATED TEMPERATURES (°C)						UNITS	
		V _{DD} (V)		+25					
		-55	-40	+85	+125	Typ.	Max.		
Control (V_C)									
Control Input Low Voltage, V _{ILC} (Max.)	I _{is} < 10 μA V _{is} = V _{SS} , V _{OS} = V _{DD} and V _{is} = V _{DD} , V _{OS} = V _{SS}	5, 10, 15	0.9	0.9	0.4	0.4	-	0.7	V
Control Input High Voltage, V _{IHC}	See Fig. 10	5, 10, 15	3.5 (Min.) 7 (Min.) 11 (Min.)				-	-	V
Input Current, I _{IN} (Max.)	V _{is} ≤ V _{DD} V _{DD} - V _{SS} = 18 V V _{CC} ≤ V _{DD} - V _{SS}	18	±0.1	±0.1	±1	±1	±10 ⁻⁵	±0.1	μA
Crosstalk (Control Input to Signal Output)	V _C = 10 V (Sq. Wave) t _r , t _f = 20 ns R _L = 10 kΩ	10	-	-	-	-	50	-	mV
Turn-On Propagation Delay	t _r , t _f = 20 ns C _L = 50 pF R _L = 1 kΩ	5, 10, 15	-	-	-	-	35, 20, 15	70, 40, 30	ns
Maximum Control Input Repetition Rate	V _{is} = V _{DD} , V _{SS} = GND, R _L = 1 kΩ to gnd, C _L = 50 pF, V _C = 10 V (Square wave centered on 5 V) t _r , t _f = 20 ns, V _{os} = ½ V _{os} @ 1 kHz	10	-	-	-	-	10	-	MHz
Input Capacitance, C _{IN}			-	-	-	-	5	7.5	μF

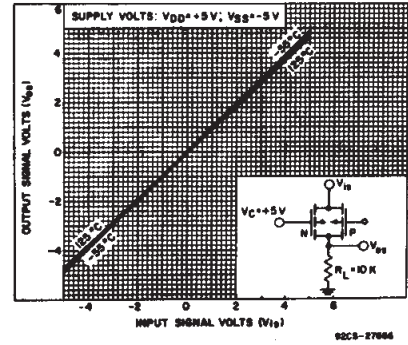

Fig. 7—Typ. on-state characteristics as a function of temp. for 1 of 4 switches with V_{DD} = +5 V, V_{SS} = -5 V.

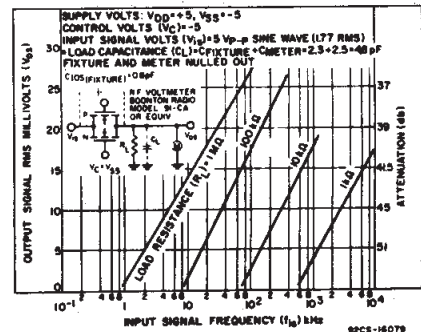

Fig. 8—Typ. feedthrough vs. frequency—switch off.

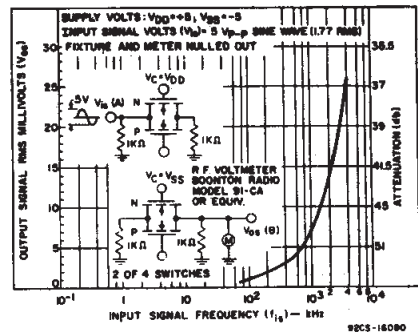

Fig. 9—Typical crosstalk between switch circuits in the same package.

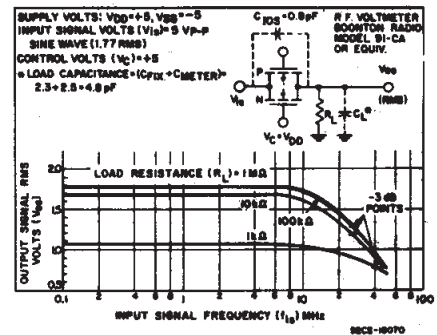

Fig. 11—Typical frequency response—switch on.

V _{DD} (V)	V _{is} (V)	Switch Input I _{is} (mA)						Switch Output V _{os} (V)	
		-55°C	-40°C	25°C*	25°C▲	+85°C	+125°C	Min.	Max.
5	0	0.25	0.2	0.2	0.16	0.12	0.14	-	0.4
5	5	-0.25	-0.2	-0.2	-0.16	-0.12	-0.14	4.6	-
10	0	0.62	0.5	0.5	0.4	0.3	0.35	-	0.5
10	10	-0.62	-0.5	-0.5	-0.4	-0.3	-0.35	9.5	-
15	0	1.8	1.4	1.5	1.2	1	1.1	-	1.5
15	15	-1.8	-1.4	-1.5	-1.2	-1	-1.1	13.5	-

* Plastic package

▲ Ceramic package

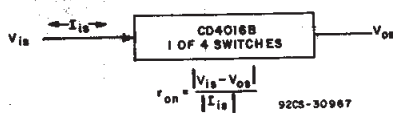

Fig. 10—Determination of r_{on} as a test condition for control input high voltage (V_{IHC}) specification.

CD4016B Types

TYPICAL ON-STATE RESISTANCE CHARACTERISTICS, $T_A = 25^\circ\text{C}$

CHARACTERISTIC*	SUPPLY CONDITIONS		LOAD CONDITIONS					
			$R_L = 1k\Omega$		$R_L = 10k\Omega$		$R_L = 100k\Omega$	
			VALUE (Ω)	V_{IS} (V)	VALUE (Ω)	V_{IS} (V)	VALUE (Ω)	V_{IS} (V)
r_{on}	+15	0	200	+15	200	+15	180	+15
r_{on} (max.)	+15	0	200	0	200	0	200	0
r_{on}	+10	0	290	+10	250	+10	240	+10
r_{on} (max.)	+10	0	290	0	250	0	300	0
r_{on}	+10	0	500	+7.4	560	+5.6	610	+5.5
r_{on}	+5	0	860	+5	470	+5	450	+5
r_{on} (max.)	+5	0	600	0	580	0	800	0
r_{on}	+5	0	1.7k	+4.2	7k	+2.9	33k	+2.7
r_{on}	+7.5	-7.5	200	+7.5	200	+7.5	180	+7.5
r_{on} (max.)	+7.5	-7.5	200	-7.5	200	-7.5	180	-7.5
r_{on}	+7.5	-7.5	290	± 0.25	280	± 25	400	± 0.25
r_{on}	+5	-5	260	+5	250	+5	240	+5
r_{on} (max.)	+5	-5	310	-5	250	-5	240	-5
r_{on}	+5	-5	600	± 0.25	580	± 0.25	760	± 0.25
r_{on}	+2.5	-2.5	590	+2.5	450	+2.5	490	+2.5
r_{on} (max.)	+2.5	-2.5	720	-2.5	520	-2.5	520	-2.5
r_{on}	+2.5	-2.5	232k	± 0.25	300k	± 0.25	870k	± 0.25

* Variation from perfect switch, $r_{on} = 0 \Omega$.

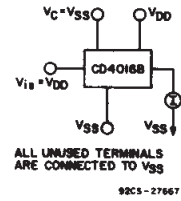

Fig. 12 - Off-state switch input or output leakage current test circuit.

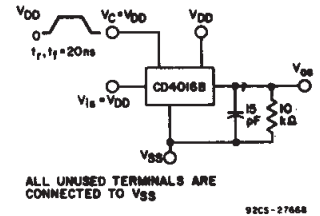
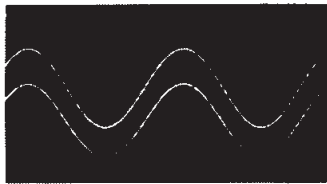

Fig. 13 - Test circuit for square-wave response.



SCALE: X = 0.2 ms/DIV Y = 2.0 V/DIV
 $V_{DD} = V_C = +7.5V, V_{SS} = -7.5V, R_L = 10K\Omega$
 $C_L = 15 pF$
 $f_{IS} = 1 KHz, V_{IS} = 5V p-p$
 DISTORTION = 0.2 %

92CS-27612

Fig. 14 - Typical sine wave response of $V_{DD} = +7.5 V, V_{SS} = -7.5 V$.



SCALE: X = 0.2 ms/DIV Y = 2.0 V/DIV
 $V_{DD} = V_C = +5V, V_{SS} = -5V, R_L = 10K\Omega$
 $C_L = 15 pF$
 $f_{IS} = 1 KHz, V_{IS} = 5V p-p$
 DISTORTION = 0.4 %

92CS-27613

Fig. 15 - Typical sine wave response of $V_{DD} = +5 V, V_{SS} = -5 V$.

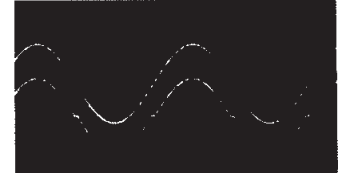

SCALE: X = 0.2 ms/DIV Y = 2.0 V/DIV
 $V_{DD} = V_C = +2.5V, V_{SS} = -2.5V, R_L = 10K\Omega$
 $C_L = 15 pF$
 $f_{IS} = 1 KHz, V_{IS} = 5V p-p$
 DISTORTION = 3 %

92CS-27614

Fig. 16 - Typical sine wave response of $V_{DD} = +2.5 V, V_{SS} = -2.5 V$.

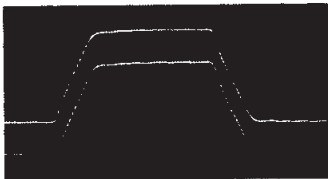

SCALE: X = 100 ns/DIV
 Y = 5.0 V/DIV

92CS-27615

Fig. 17 - Typical square wave response at $V_{DD} = V_C = +15 V, V_{SS} = Gnd$.



SCALE: X = 100 ns/DIV
 Y = 5.0 V/DIV

92CS-27616

Fig. 18 - Typical square wave response at $V_{DD} = V_C = +10 V, V_{SS} = Gnd$.



SCALE: X = 100 ns/DIV
 Y = 2 V/DIV

92CS-27617

Fig. 19 - Typical square wave response at $V_{DD} = V_C = +5 V, V_{SS} = Gnd$.

3
 COMMERCIAL CMOS
 HIGH VOLTAGE ICs

CD4016B Types

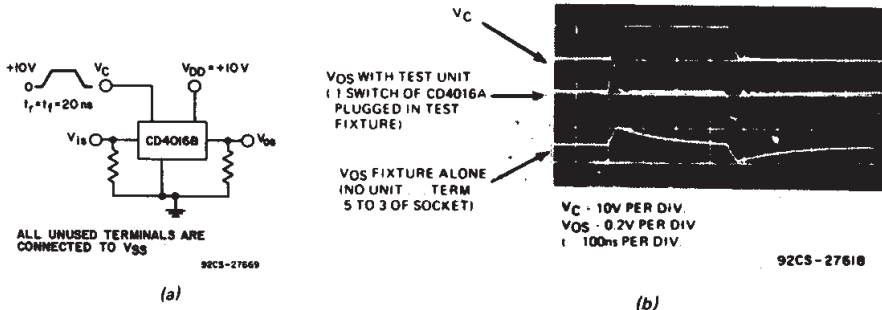

Fig. 20 - Crosstalk-control input to signal output.

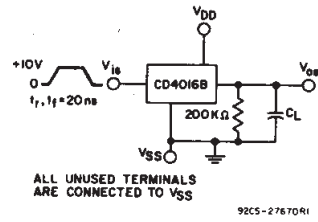

Fig. 21 - Propagation delay time signal input (V_{IS}) to signal output (V_{OS}).

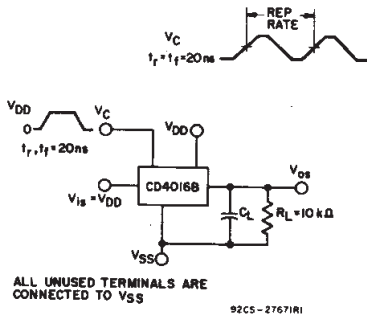

Fig. 22 - Max. control-input repetition rate.

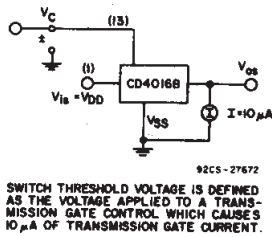

Fig. 23 - Switch threshold voltage.

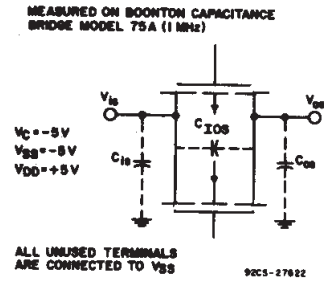

Fig. 24 - Capacitance C_{IOs} and C_{OS} .

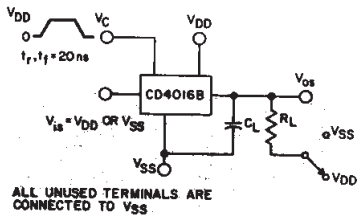
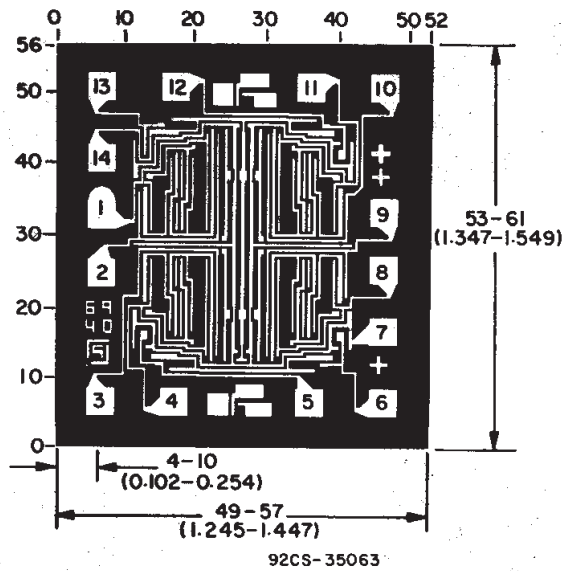

Fig. 25 - Turn-On propagation delay-control input.

Dimensions and pad layout for CD4016BH



Dimensions in parentheses are in millimeters and are derived from the basic inch dimensions as indicated. Grid graduations are in mils (10^{-3} inch).

PACKAGING INFORMATION

Orderable Device	Status (1)	Package Type	Package Drawing	Pins	Package Qty	Eco Plan (2)	Lead/Ball Finish	MSL Peak Temp (3)	Op Temp (°C)	Device Marking (4/5)	Samples
5962-9064001CA	ACTIVE	CDIP	J	14	1	TBD	A42	N / A for Pkg Type	-55 to 125	5962-9064001CA CD4016BF3A	Samples
CD4016BE	ACTIVE	PDIP	N	14	25	Pb-Free (RoHS)	CU NIPDAU	N / A for Pkg Type	-55 to 125	CD4016BE	Samples
CD4016BEE4	ACTIVE	PDIP	N	14	25	Pb-Free (RoHS)	CU NIPDAU	N / A for Pkg Type	-55 to 125	CD4016BE	Samples
CD4016BF	ACTIVE	CDIP	J	14	1	TBD	A42	N / A for Pkg Type	-55 to 125	CD4016BF	Samples
CD4016BF3A	ACTIVE	CDIP	J	14	1	TBD	A42	N / A for Pkg Type	-55 to 125	5962-9064001CA CD4016BF3A	Samples
CD4016BM	ACTIVE	SOIC	D	14	50	Green (RoHS & no Sb/Br)	CU NIPDAU	Level-1-260C-UNLIM	-55 to 125	CD4016BM	Samples
CD4016BM96	ACTIVE	SOIC	D	14	2500	Green (RoHS & no Sb/Br)	CU NIPDAU	Level-1-260C-UNLIM	-55 to 125	CD4016BM	Samples
CD4016BM96E4	ACTIVE	SOIC	D	14	2500	Green (RoHS & no Sb/Br)	CU NIPDAU	Level-1-260C-UNLIM	-55 to 125	CD4016BM	Samples
CD4016BM96G4	ACTIVE	SOIC	D	14	2500	Green (RoHS & no Sb/Br)	CU NIPDAU	Level-1-260C-UNLIM	-55 to 125	CD4016BM	Samples
CD4016BME4	ACTIVE	SOIC	D	14	50	Green (RoHS & no Sb/Br)	CU NIPDAU	Level-1-260C-UNLIM	-55 to 125	CD4016BM	Samples
CD4016BMG4	ACTIVE	SOIC	D	14	50	Green (RoHS & no Sb/Br)	CU NIPDAU	Level-1-260C-UNLIM	-55 to 125	CD4016BM	Samples
CD4016BMT	ACTIVE	SOIC	D	14	250	Green (RoHS & no Sb/Br)	CU NIPDAU	Level-1-260C-UNLIM	-55 to 125	CD4016BM	Samples
CD4016BMTE4	ACTIVE	SOIC	D	14	250	Green (RoHS & no Sb/Br)	CU NIPDAU	Level-1-260C-UNLIM	-55 to 125	CD4016BM	Samples
CD4016BMTG4	ACTIVE	SOIC	D	14	250	Green (RoHS & no Sb/Br)	CU NIPDAU	Level-1-260C-UNLIM	-55 to 125	CD4016BM	Samples
CD4016BNSR	ACTIVE	SO	NS	14	2000	Green (RoHS & no Sb/Br)	CU NIPDAU	Level-1-260C-UNLIM	-55 to 125	CD4016B	Samples
CD4016BNSRE4	ACTIVE	SO	NS	14	2000	Green (RoHS & no Sb/Br)	CU NIPDAU	Level-1-260C-UNLIM	-55 to 125	CD4016B	Samples
CD4016BNSRG4	ACTIVE	SO	NS	14	2000	Green (RoHS & no Sb/Br)	CU NIPDAU	Level-1-260C-UNLIM	-55 to 125	CD4016B	Samples

Orderable Device	Status (1)	Package Type	Package Drawing	Pins	Package Qty	Eco Plan (2)	Lead/Ball Finish	MSL Peak Temp (3)	Op Temp (°C)	Device Marking (4/5)	Samples
CD4016BPW	ACTIVE	TSSOP	PW	14	90	Green (RoHS & no Sb/Br)	CU NIPDAU	Level-1-260C-UNLIM	-55 to 125	CM016B	Samples
CD4016BPWE4	ACTIVE	TSSOP	PW	14	90	Green (RoHS & no Sb/Br)	CU NIPDAU	Level-1-260C-UNLIM	-55 to 125	CM016B	Samples
CD4016BPWG4	ACTIVE	TSSOP	PW	14	90	Green (RoHS & no Sb/Br)	CU NIPDAU	Level-1-260C-UNLIM	-55 to 125	CM016B	Samples
CD4016BPWR	ACTIVE	TSSOP	PW	14	2000	Green (RoHS & no Sb/Br)	CU NIPDAU	Level-1-260C-UNLIM	-55 to 125	CM016B	Samples
CD4016BPWRE4	ACTIVE	TSSOP	PW	14	2000	Green (RoHS & no Sb/Br)	CU NIPDAU	Level-1-260C-UNLIM	-55 to 125	CM016B	Samples
CD4016BPWRG4	ACTIVE	TSSOP	PW	14	2000	Green (RoHS & no Sb/Br)	CU NIPDAU	Level-1-260C-UNLIM	-55 to 125	CM016B	Samples

(1) The marketing status values are defined as follows:

ACTIVE: Product device recommended for new designs.

LIFEBUY: TI has announced that the device will be discontinued, and a lifetime-buy period is in effect.

NRND: Not recommended for new designs. Device is in production to support existing customers, but TI does not recommend using this part in a new design.

PREVIEW: Device has been announced but is not in production. Samples may or may not be available.

OBSELETE: TI has discontinued the production of the device.

(2) Eco Plan - The planned eco-friendly classification: Pb-Free (RoHS), Pb-Free (RoHS Exempt), or Green (RoHS & no Sb/Br) - please check <http://www.ti.com/productcontent> for the latest availability information and additional product content details.

TBD: The Pb-Free/Green conversion plan has not been defined.

Pb-Free (RoHS): TI's terms "Lead-Free" or "Pb-Free" mean semiconductor products that are compatible with the current RoHS requirements for all 6 substances, including the requirement that lead not exceed 0.1% by weight in homogeneous materials. Where designed to be soldered at high temperatures, TI Pb-Free products are suitable for use in specified lead-free processes.

Pb-Free (RoHS Exempt): This component has a RoHS exemption for either 1) lead-based flip-chip solder bumps used between the die and package, or 2) lead-based die adhesive used between the die and leadframe. The component is otherwise considered Pb-Free (RoHS compatible) as defined above.

Green (RoHS & no Sb/Br): TI defines "Green" to mean Pb-Free (RoHS compatible), and free of Bromine (Br) and Antimony (Sb) based flame retardants (Br or Sb do not exceed 0.1% by weight in homogeneous material)

(3) MSL, Peak Temp. -- The Moisture Sensitivity Level rating according to the JEDEC industry standard classifications, and peak solder temperature.

(4) There may be additional marking, which relates to the logo, the lot trace code information, or the environmental category on the device.

(5) Multiple Device Markings will be inside parentheses. Only one Device Marking contained in parentheses and separated by a "-" will appear on a device. If a line is indented then it is a continuation of the previous line and the two combined represent the entire Device Marking for that device.

Important Information and Disclaimer: The information provided on this page represents TI's knowledge and belief as of the date that it is provided. TI bases its knowledge and belief on information provided by third parties, and makes no representation or warranty as to the accuracy of such information. Efforts are underway to better integrate information from third parties. TI has taken and continues to take reasonable steps to provide representative and accurate information but may not have conducted destructive testing or chemical analysis on incoming materials and chemicals. TI and TI suppliers consider certain information to be proprietary, and thus CAS numbers and other limited information may not be available for release.

In no event shall TI's liability arising out of such information exceed the total purchase price of the TI part(s) at issue in this document sold by TI to Customer on an annual basis.

OTHER QUALIFIED VERSIONS OF CD4016B, CD4016B-MIL :

- Catalog: [CD4016B](#)
- Military: [CD4016B-MIL](#)

NOTE: Qualified Version Definitions:

- Catalog - TI's standard catalog product
- Military - QML certified for Military and Defense Applications

TAPE AND REEL INFORMATION
REEL DIMENSIONS

TAPE DIMENSIONS

A0	Dimension designed to accommodate the component width
B0	Dimension designed to accommodate the component length
K0	Dimension designed to accommodate the component thickness
W	Overall width of the carrier tape
P1	Pitch between successive cavity centers

TAPE AND REEL INFORMATION

*All dimensions are nominal

Device	Package Type	Package Drawing	Pins	SPQ	Reel Diameter (mm)	Reel Width W1 (mm)	A0 (mm)	B0 (mm)	K0 (mm)	P1 (mm)	W (mm)	Pin1 Quadrant
CD4016BM96	SOIC	D	14	2500	330.0	16.4	6.5	9.0	2.1	8.0	16.0	Q1
CD4016BMT	SOIC	D	14	250	330.0	16.4	6.5	9.0	2.1	8.0	16.0	Q1
CD4016BNSR	SO	NS	14	2000	330.0	16.4	8.2	10.5	2.5	12.0	16.0	Q1
CD4016BPWR	TSSOP	PW	14	2000	330.0	12.4	6.9	5.6	1.6	8.0	12.0	Q1

TAPE AND REEL BOX DIMENSIONS

*All dimensions are nominal

Device	Package Type	Package Drawing	Pins	SPQ	Length (mm)	Width (mm)	Height (mm)
CD4016BM96	SOIC	D	14	2500	367.0	367.0	38.0
CD4016BMT	SOIC	D	14	250	367.0	367.0	38.0
CD4016BNSR	SO	NS	14	2000	367.0	367.0	38.0
CD4016BPWR	TSSOP	PW	14	2000	367.0	367.0	35.0

J (R-GDIP-T**)

14 LEADS SHOWN

CERAMIC DUAL IN-LINE PACKAGE



DIM \ PINS **	14	16	18	20
A	0.300 (7,62) BSC	0.300 (7,62) BSC	0.300 (7,62) BSC	0.300 (7,62) BSC
B MAX	0.785 (19,94)	.840 (21,34)	0.960 (24,38)	1.060 (26,92)
B MIN	—	—	—	—
C MAX	0.300 (7,62)	0.300 (7,62)	0.310 (7,87)	0.300 (7,62)
C MIN	0.245 (6,22)	0.245 (6,22)	0.220 (5,59)	0.245 (6,22)



4040083/F 03/03

- NOTES:
- All linear dimensions are in inches (millimeters).
 - This drawing is subject to change without notice.
 - This package is hermetically sealed with a ceramic lid using glass frit.
 - Index point is provided on cap for terminal identification only on press ceramic glass frit seal only.
 - Falls within MIL STD 1835 GDIP1-T14, GDIP1-T16, GDIP1-T18 and GDIP1-T20.

N (R-PDIP-T**)

PLASTIC DUAL-IN-LINE PACKAGE

16 PINS SHOWN



- NOTES:
- A. All linear dimensions are in inches (millimeters).
 - B. This drawing is subject to change without notice.
 - Falls within JEDEC MS-001, except 18 and 20 pin minimum body length (Dim A).
 - The 20 pin end lead shoulder width is a vendor option, either half or full width.

D (R-PDSO-G14)

PLASTIC SMALL OUTLINE



4040047-5/M 06/11

- NOTES:
- A. All linear dimensions are in inches (millimeters).
 - B. This drawing is subject to change without notice.
 -  Body length does not include mold flash, protrusions, or gate burrs. Mold flash, protrusions, or gate burrs shall not exceed 0.006 (0,15) each side.
 -  Body width does not include interlead flash. Interlead flash shall not exceed 0.017 (0,43) each side.
 - E. Reference JEDEC MS-012 variation AB.

D (R-PDSO-G14)

PLASTIC SMALL OUTLINE



- NOTES:
- A. All linear dimensions are in millimeters.
 - B. This drawing is subject to change without notice.
 - C. Publication IPC-7351 is recommended for alternate designs.
 - D. Laser cutting apertures with trapezoidal walls and also rounding corners will offer better paste release. Customers should contact their board assembly site for stencil design recommendations. Refer to IPC-7525 for other stencil recommendations.
 - E. Customers should contact their board fabrication site for solder mask tolerances between and around signal pads.

PW (R-PDSO-G14)

PLASTIC SMALL OUTLINE



- NOTES:
- A. All linear dimensions are in millimeters. Dimensioning and tolerancing per ASME Y14.5M-1994.
 - B. This drawing is subject to change without notice.
 - C. Body length does not include mold flash, protrusions, or gate burrs. Mold flash, protrusions, or gate burrs shall not exceed 0,15 each side.
 - D. Body width does not include interlead flash. Interlead flash shall not exceed 0,25 each side.
 - E. Falls within JEDEC MO-153

PW (R-PDSO-G14)

PLASTIC SMALL OUTLINE



- NOTES:
- All linear dimensions are in millimeters.
 - This drawing is subject to change without notice.
 - Publication IPC-7351 is recommended for alternate designs.
 - Laser cutting apertures with trapezoidal walls and also rounding corners will offer better paste release. Customers should contact their board assembly site for stencil design recommendations. Refer to IPC-7525 for other stencil recommendations.
 - Customers should contact their board fabrication site for solder mask tolerances between and around signal pads.

MECHANICAL DATA

NS (R-PDSO-G)**

PLASTIC SMALL-OUTLINE PACKAGE

14-PINS SHOWN

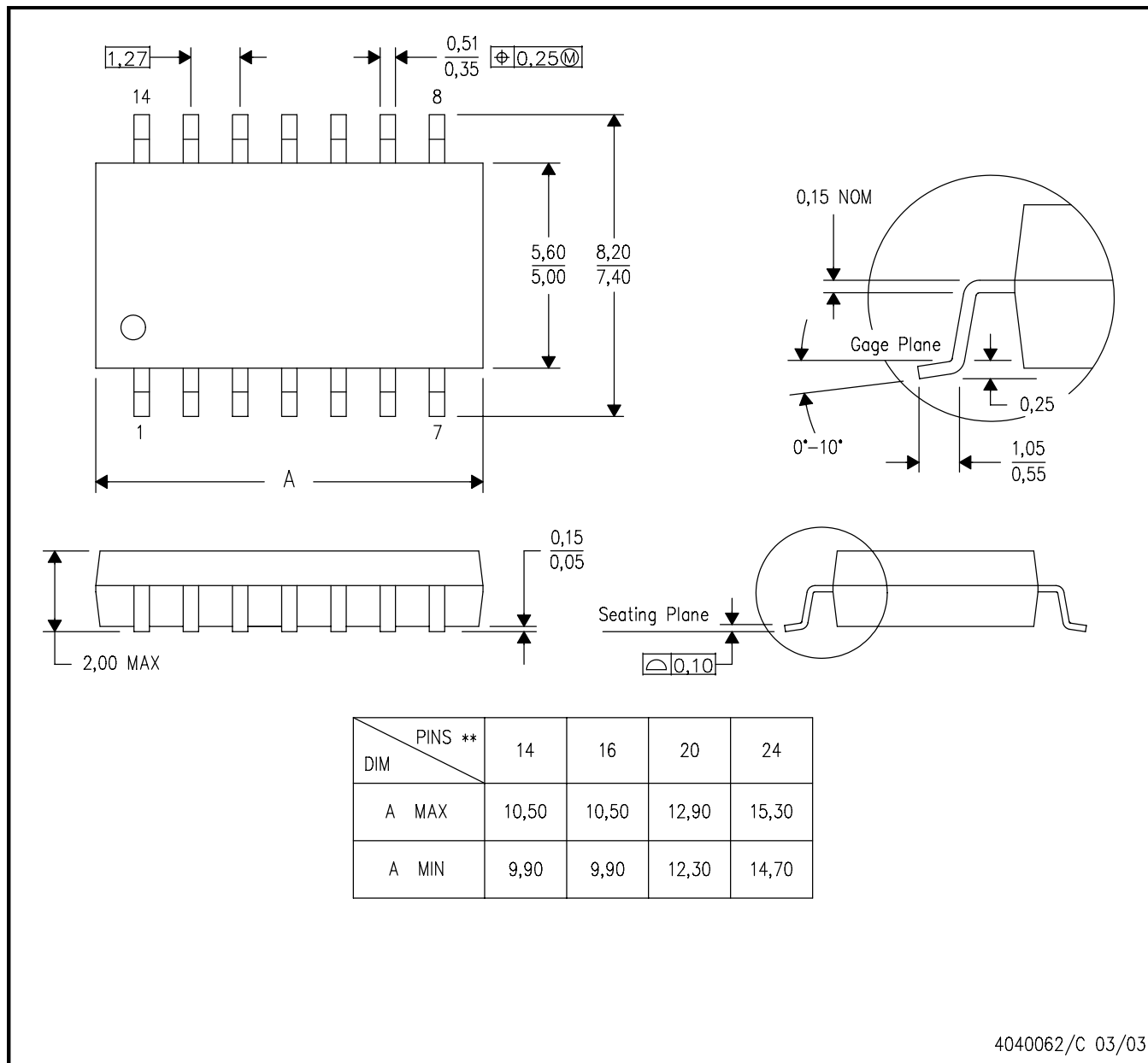

- NOTES:
- A. All linear dimensions are in millimeters.
 - B. This drawing is subject to change without notice.
 - C. Body dimensions do not include mold flash or protrusion, not to exceed 0,15.

IMPORTANT NOTICE

Texas Instruments Incorporated and its subsidiaries (TI) reserve the right to make corrections, enhancements, improvements and other changes to its semiconductor products and services per JESD46, latest issue, and to discontinue any product or service per JESD48, latest issue. Buyers should obtain the latest relevant information before placing orders and should verify that such information is current and complete. All semiconductor products (also referred to herein as "components") are sold subject to TI's terms and conditions of sale supplied at the time of order acknowledgment.

TI warrants performance of its components to the specifications applicable at the time of sale, in accordance with the warranty in TI's terms and conditions of sale of semiconductor products. Testing and other quality control techniques are used to the extent TI deems necessary to support this warranty. Except where mandated by applicable law, testing of all parameters of each component is not necessarily performed.

TI assumes no liability for applications assistance or the design of Buyers' products. Buyers are responsible for their products and applications using TI components. To minimize the risks associated with Buyers' products and applications, Buyers should provide adequate design and operating safeguards.

TI does not warrant or represent that any license, either express or implied, is granted under any patent right, copyright, mask work right, or other intellectual property right relating to any combination, machine, or process in which TI components or services are used. Information published by TI regarding third-party products or services does not constitute a license to use such products or services or a warranty or endorsement thereof. Use of such information may require a license from a third party under the patents or other intellectual property of the third party, or a license from TI under the patents or other intellectual property of TI.

Reproduction of significant portions of TI information in TI data books or data sheets is permissible only if reproduction is without alteration and is accompanied by all associated warranties, conditions, limitations, and notices. TI is not responsible or liable for such altered documentation. Information of third parties may be subject to additional restrictions.

Resale of TI components or services with statements different from or beyond the parameters stated by TI for that component or service voids all express and any implied warranties for the associated TI component or service and is an unfair and deceptive business practice. TI is not responsible or liable for any such statements.

Buyer acknowledges and agrees that it is solely responsible for compliance with all legal, regulatory and safety-related requirements concerning its products, and any use of TI components in its applications, notwithstanding any applications-related information or support that may be provided by TI. Buyer represents and agrees that it has all the necessary expertise to create and implement safeguards which anticipate dangerous consequences of failures, monitor failures and their consequences, lessen the likelihood of failures that might cause harm and take appropriate remedial actions. Buyer will fully indemnify TI and its representatives against any damages arising out of the use of any TI components in safety-critical applications.

In some cases, TI components may be promoted specifically to facilitate safety-related applications. With such components, TI's goal is to help enable customers to design and create their own end-product solutions that meet applicable functional safety standards and requirements. Nonetheless, such components are subject to these terms.

No TI components are authorized for use in FDA Class III (or similar life-critical medical equipment) unless authorized officers of the parties have executed a special agreement specifically governing such use.

Only those TI components which TI has specifically designated as military grade or "enhanced plastic" are designed and intended for use in military/aerospace applications or environments. Buyer acknowledges and agrees that any military or aerospace use of TI components which have **not** been so designated is solely at the Buyer's risk, and that Buyer is solely responsible for compliance with all legal and regulatory requirements in connection with such use.

TI has specifically designated certain components as meeting ISO/TS16949 requirements, mainly for automotive use. In any case of use of non-designated products, TI will not be responsible for any failure to meet ISO/TS16949.

Products

Audio	www.ti.com/audio
Amplifiers	amplifier.ti.com
Data Converters	dataconverter.ti.com
DLP® Products	www.dlp.com
DSP	dsp.ti.com
Clocks and Timers	www.ti.com/clocks
Interface	interface.ti.com
Logic	logic.ti.com
Power Mgmt	power.ti.com
Microcontrollers	microcontroller.ti.com
RFID	www.ti-rfid.com
OMAP Applications Processors	www.ti.com/omap
Wireless Connectivity	www.ti.com/wirelessconnectivity

Applications

Automotive and Transportation	www.ti.com/automotive
Communications and Telecom	www.ti.com/communications
Computers and Peripherals	www.ti.com/computers
Consumer Electronics	www.ti.com/consumer-apps
Energy and Lighting	www.ti.com/energy
Industrial	www.ti.com/industrial
Medical	www.ti.com/medical
Security	www.ti.com/security
Space, Avionics and Defense	www.ti.com/space-avionics-defense
Video and Imaging	www.ti.com/video

TI E2E Community

e2e.ti.com