

A 0.6-3VIN, 1.8-3.6VOUT, 3.5µA, High-Efficiency Boost + Output Load Switch

FEATURES

- ◆ Boost Regulator
 - Input Voltage: 0.6V- 3V
 - Output Voltage: 3V
 - Shutdown Control Jumper
 - Coilcraft 10µH Inductor (LPS4018-103ML)
 - Resistor Pad Available for Anti-Crush™ Voltage Setting

COMPONENT LIST

DESIGNATION	QTY	DESCRIPTION
L1	1	10µH ±20% Shielded Inductor (4mmx4mm) LPS4018-103ML
C1, C4	2	22µF ±10% capacitor (X5R) (25V) (1206) GRM31CR61E226KE15L
C2	1	3.3nF ±10% capacitor (0603), 445-5084-2-ND
R1, R6	2	1.37MΩ ± 1% (0805), 311-1.37MCRTR-ND
R3	1	6.81MΩ ± 1% (0805), 311-6.81MCRTR-ND
U1	1	TS3300
BOOST, BOOST_OUT, REG_OUT, GND (2)	5	Test points
J1, J3, REG_IN	3	Jumper

DESCRIPTION

The demo board for the TS3300 is a completely assembled and tested circuit board that can be used for evaluating the TS3300. The TS3300 is a first generation Touchstone Semi power management product that combines a high-efficiency boost regulator plus an output load switch in one package.

The TS3300 includes an *anti-crush™* feature to prevent the collapse of the input voltage to the boost regulator when the input is a weak (high impedance) source. If the input voltage drops below a pre-determined voltage threshold (settable by a resistor divider), the boost regulator switching cycles are paused, effectively limiting the minimum input voltage. A pull-down resistor pad is available in order to set the *anti-crush™* voltage.

The TS3300 boost regulator is set to an output voltage of 3V via a resistor divider circuit. The TS3300 is fully specified over the -40°C to +85°C temperature range and is available in a low-profile, thermally-enhanced 16-pin 3x3mm TQFN package with an exposed back-side paddle.

Product datasheet and additional documentation can be found on the factory web site at www.touchstonesemi.com.

ORDERING INFORMATION

Order Number	Description
TS3300DB	TS3300 Demo Board

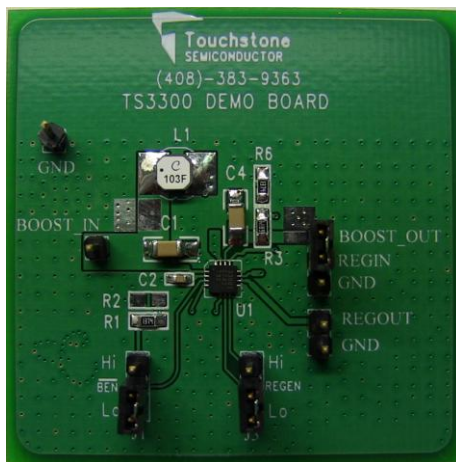

Figure 1. TS3300 Demo Board (Top View)

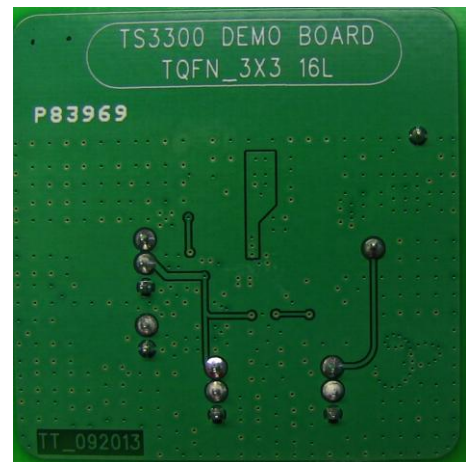

Figure 2. TS3300 Demo Board (Bottom View)

DESCRIPTION

BOOST REGULATOR OUTPUT VOLTAGE SETTING

The TS3300 boost regulator is set to an output voltage of 3V via a resistor divider circuit as shown in Figure 3.

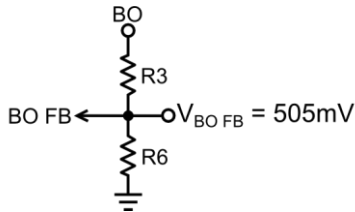

Figure 3: Setting the Boost Output Voltage with a Voltage Divider

The output feedback (BO FB) pin is 505mV. It is recommended to use large resistor values to minimize additional current draw at the output. Resistor values less than 8MΩ are recommended. Boost output voltage can be set by solving for R3 for a given R6 value in the following equation:

$$R3 = \frac{(V_{BO} - 0.505)R6}{0.505}$$

To set a 3V output voltage with R6 = 1.37MΩ, R3 is calculated to be 6.77MΩ. A 1% standard resistor value of 6.81MΩ is selected. This results in an output voltage of 3.02V.

ANTI-CRUSH™ VOLTAGE SETTING

To set the *anti-crush™* voltage, a feedback pin (BI FB) in conjunction with a voltage divider circuit can be implemented as shown in Figure 4. The feedback pin voltage is 392mV. It is recommended to use large resistor values to minimize additional current draw at the input.

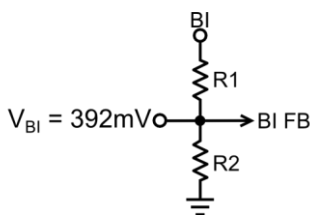

Figure 4: Setting the Anti-Crush™ Voltage with a Voltage Divider

Using the following equation to solve for R1 for a given R2 value, the output voltage can be set:

$$R1 = \frac{(V_{\text{ANTI-CRUSH}} - 0.392)R2}{0.392}$$

To set a 0.8V output voltage with R2 = 1.37MΩ, R1 is calculated to be 1.42MΩ. A 1% standard resistor value of 1.37MΩ is selected. This results in an anti-crush voltage of 784mV. The *anti-crush™* voltage is to be set above the minimum input voltage specification of the TS3300. Refer to the TS3300 product datasheet “Applications Information” section for more details.

TS3300 CONFIGURATIONS

The TS3300 can be operated in either a Boost Only Configuration or in a Boost + Output Load Switch Configuration. The TS3300 Demo Board is designed so that both circuit configurations can be evaluated. Two sets of Quick Start Procedures are provided detailing how to evaluate each circuit configuration. If the Output Load Switch is not needed, it is recommended to use the Boost Only Configuration, since the lowest quiescent current is achievable this way.

QUICK START PROCEDURE

Required Equipment

- TS3300 Demo Board
- 1.2V Battery or Power Supply
- Two Digital Multimeters
- Oscilloscope

Boost + Output Load Switch Configuration

To evaluate the Boost + Output Load Switch configuration, the following steps are to be performed.

- 1) Connect Jumper J1 LOW. The $\overline{\text{BEN}}$ pin should be connected to the Lo pin, otherwise PCB ground.
- 2) Connect the provided Jumper so that the REGIN pin is connected to the BOOST_OUT pin.
- 3) Connect Jumper J3 LOW. The REGEN pin should be connected to the Lo pin, otherwise PCB ground.
- 4) Connect the battery positive terminal to the test point labeled BOOST_IN. Connect the negative terminal of the battery to the test point labeled GND.

- 5) To monitor the boost regulator output voltage, connect the positive terminal of the voltmeter to the test point labeled BOOST_OUT. Connect the negative terminal of the voltmeter to the test point labeled GND. Connect the Oscilloscope probe to the test point labeled BOOST_OUT to monitor the output ripple. The BOOST_OUT voltage should be regulated at approximately 3.02V.
- 6) To monitor the output load switch voltage, V_{REGOUT} , connect the positive terminal of the voltmeter to the test point labeled REGOUT. Connect the negative terminal of the voltmeter to the test point labeled GND. The REGOUT voltage should be regulated at approximately 3.02V. Connect the Oscilloscope probe to the test point labeled REGOUT to monitor the output load switch.
- 7) To disable the Output Load Switch, connect Jumper J3 HIGH. The REGEN pin should be connected to the Hi pin, otherwise REGIN. The output load switch voltage, V_{REGOUT} , should drop to 0V.
- 8) To enable the Output Load Switch, connect Jumper J3 LOW. The REGEN pin should be connected to the Lo pin, otherwise PCB ground. The output load switch voltage, V_{REGOUT} , should be approximately equal to V_{BOOST_OUT} .

OUTPUT LOAD SWITCH FUNCTION				
REG FB	SW EN	REGIN	REG EN	FUNCTION
REG FB, SW EN, REGIN should be connected to BO.			High	$V_{REGOUT}=GND$ (OFF State)
			Low	$V_{REGOUT}=V_{BO}$ (ON State)

Table 1. Output Load Switch settings for Boost + Output Load Switch Configuration

Boost Only Configuration

To evaluate the Boost Only configuration, the following steps are to be performed.

- 1) Connect Jumper J1 LOW. The \overline{BEN} pin should be connected to the Lo pin, otherwise PCB ground.
- 2) Connect the provided Jumper so that the REGIN pin is connected to the GND pin.
- 3) Connect Jumper J3 LOW. The REGEN pin should be connected to the LO pin, otherwise PCB ground.
- 4) Connect REGOUT to PCB Ground.
- 5) Connect the battery positive terminal to the test point labeled BOOST_IN. Connect the negative terminal of the battery to the test point labeled GND.
- 6) To monitor the boost regulator output voltage, connect the positive terminal of the voltmeter to the test point labeled BOOST_OUT. Connect the negative terminal of the voltmeter to the test point labeled GND. Connect the Oscilloscope probe to the test point labeled BOOST_OUT to monitor the output ripple. The BOOST_OUT voltage should be regulated at approximately 3.02V.
- 7) To shutdown the boost regulator, connect Jumper J1 HIGH. The \overline{BEN} pin should be connected to the Hi pin, otherwise BOOST_IN. The boost output voltage, V_{BOOST_OUT} , should drop to 0V. The input supply current reduces to 0.1 μ A.

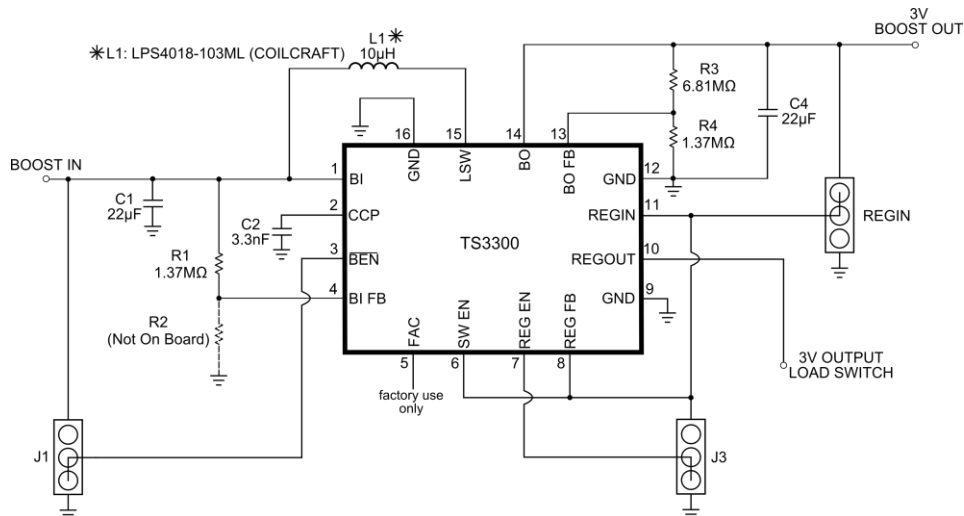

Figure 5. TS3300 Demo Board Circuit Schematic

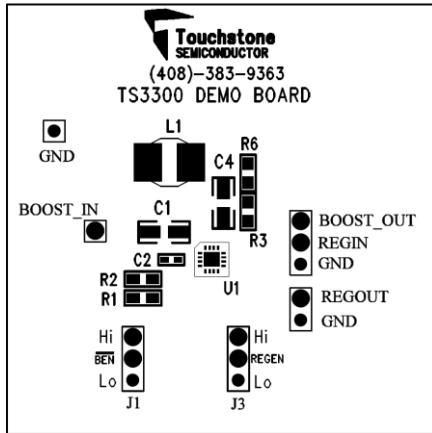

Figure 6. Top Layer #1

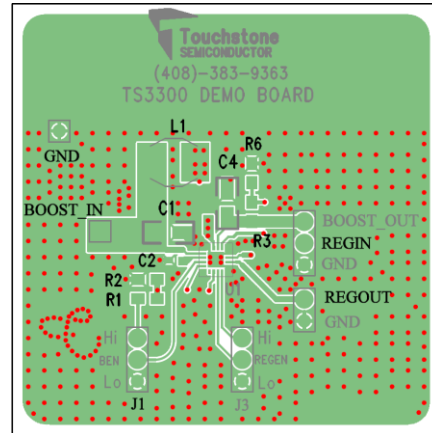

Figure 7. Top Layer #2

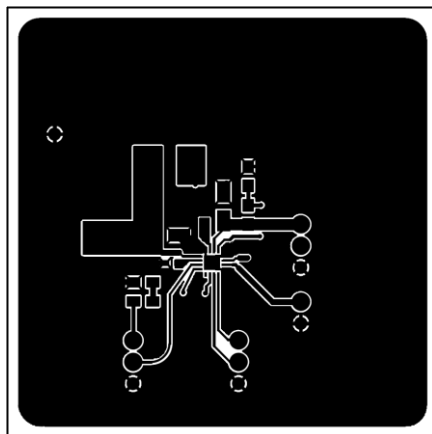

Figure 8. Top Layer #3

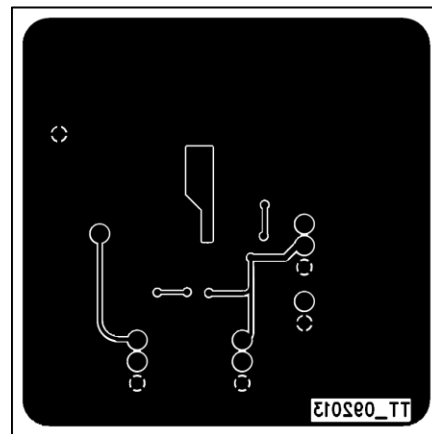

Figure 9. Bottom Layer #1

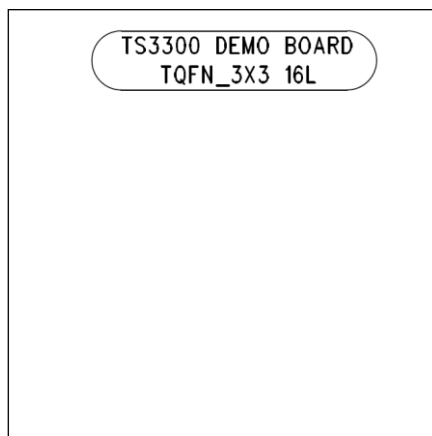

Figure 10. Bottom Layer #2

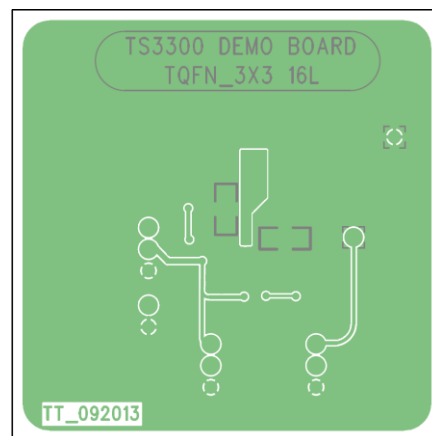

Figure 11. Bottom Layer #3