

PESDxV4UF; PESDxV4UG; PESDxV4UW

Very low capacitance unidirectional quadruple ESD protection diode arrays

Rev. 03 — 28 January 2008

Product data sheet

1. Product profile

1.1 General description

Very low capacitance unidirectional quadruple ElectroStatic Discharge (ESD) protection diode arrays in small Surface-Mounted Device (SMD) plastic packages designed to protect up to four signal lines from the damage caused by ESD and other transients.

Table 1. Product overview

Type number	Package			Package configuration
	NXP	JEITA	JEDEC	
PESD3V3V4UF	SOT886	-	MO-252	leadless ultra small
PESD5V0V4UF	SOT886	-	MO-252	leadless ultra small
PESD3V3V4UG	SOT353	SC-88A	-	very small
PESD5V0V4UG	SOT353	SC-88A	-	very small
PESD3V3V4UW	SOT665	-	-	ultra small and flat lead
PESD5V0V4UW	SOT665	-	-	ultra small and flat lead

1.2 Features

- ESD protection of up to four lines
- Very low diode capacitance
- Max. peak pulse power: $P_{PP} = 16 \text{ W}$
- Low clamping voltage: $V_{CL} = 11 \text{ V}$
- Ultra low leakage current: $I_{RM} = 25 \text{ nA}$
- ESD protection up to 12 kV
- IEC 61000-4-2; level 4 (ESD)
- IEC 61000-4-5 (surge); $I_{PP} = 1.5 \text{ A}$

1.3 Applications

- Computers and peripherals
- Audio and video equipment
- Cellular handsets and accessories
- Communication systems
- Portable electronics
- Subscriber Identity Module (SIM) card protection

1.4 Quick reference data

Table 2. Quick reference data
T_{amb} = 25 °C unless otherwise specified.

Symbol	Parameter	Conditions	Min	Typ	Max	Unit
Per diode						
V _{RWM}	reverse standoff voltage					
	PESD3V3V4UF PESD3V3V4UG PESD3V3V4UW		-	-	3.3	V
	PESD5V0V4UF PESD5V0V4UG PESD5V0V4UW		-	-	5.0	V
C _d	diode capacitance	f = 1 MHz; V _R = 0 V				
	PESD3V3V4UF PESD3V3V4UG PESD3V3V4UW		-	15	18	pF
	PESD5V0V4UF PESD5V0V4UG PESD5V0V4UW		-	12	15	pF

2. Pinning information

Table 3. Pinning

Pin	Description	Simplified outline	Symbol
PESD3V3V4UF; PESD5V0V4UF			
1	cathode (diode 1)	<p>bottom view</p>	<p>006aaa156</p>
2	common anode		
3	cathode (diode 2)		
4	cathode (diode 3)		
5	common anode		
6	cathode (diode 4)		
PESD3V3V4UG; PESD5V0V4UG			
1	cathode (diode 1)		<p>006aaa157</p>
2	common anode		
3	cathode (diode 2)		
4	cathode (diode 3)		
5	cathode (diode 4)		
PESD3V3V4UW; PESD5V0V4UW			
1	cathode (diode 1)		<p>006aaa157</p>
2	common anode		
3	cathode (diode 2)		
4	cathode (diode 3)		
5	cathode (diode 4)		

3. Ordering information

Table 4. Ordering information

Type number	Package		Version
	Name	Description	
PESD3V3V4UF PESD5V0V4UF	XSON6	plastic extremely thin small outline package; no leads; 6 terminals; body 1 × 1.45 × 0.5 mm	SOT886
PESD3V3V4UG PESD5V0V4UG	SC-88A	plastic surface-mounted package; 5 leads	SOT353
PESD3V3V4UW PESD5V0V4UW	-	plastic surface-mounted package; 5 leads	SOT665

4. Marking

Table 5. Marking codes

Type number	Marking code ^[1]
PESD3V3V4UF	A7
PESD5V0V4UF	A8
PESD3V3V4UG	V1*
PESD5V0V4UG	V2*
PESD3V3V4UW	W1
PESD5V0V4UW	W2

[1] * = -: made in Hong Kong

* = p: made in Hong Kong

* = t: made in Malaysia

* = W: made in China

5. Limiting values

Table 6. Limiting values

In accordance with the Absolute Maximum Rating System (IEC 60134).

Symbol	Parameter	Conditions	Min	Max	Unit
Per diode					
P_{PP}	peak pulse power	$t_p = 8/20 \mu s$	[1] [2] [3] -	16	W
I_{PP}	peak pulse current	$t_p = 8/20 \mu s$	[1] [2] [3] -	1.5	A
Per device					
T_j	junction temperature		-	150	°C
T_{amb}	ambient temperature		-65	+150	°C
T_{stg}	storage temperature		-65	+150	°C

[1] Non-repetitive current pulse 8/20 μs exponential decay waveform according to IEC 61000-4-5.

[2] For PESDxV4UF measured from pin 1, 3, 4 or 6 to pin 2 or 5.

[3] For PESDxV4UG and PESDxV4UW measured from pin 1, 3, 4 or 5 to pin 2.

Table 7. ESD maximum ratings
T_{amb} = 25 °C unless otherwise specified.

Symbol	Parameter	Conditions	Min	Max	Unit
Per diode					
V _{ESD}	electrostatic discharge voltage	IEC 61000-4-2 (contact discharge)	[1][2][3]	-	12 kV
		MIL-STD-883 (human body model)	-	10	kV

- [1] Device stressed with ten non-repetitive ESD pulses.
- [2] For PESDxV4UF measured from pin 1, 3, 4 or 6 to pin 2 or 5.
- [3] For PESDxV4UG and PESDxV4UW measured from pin 1, 3, 4 or 5 to pin 2.

Table 8. ESD standards compliance

Standard	Conditions
Per diode	
IEC 61000-4-2; level 4 (ESD)	> 8 kV (contact)
MIL-STD-883; class 3 (human body model)	> 4 kV

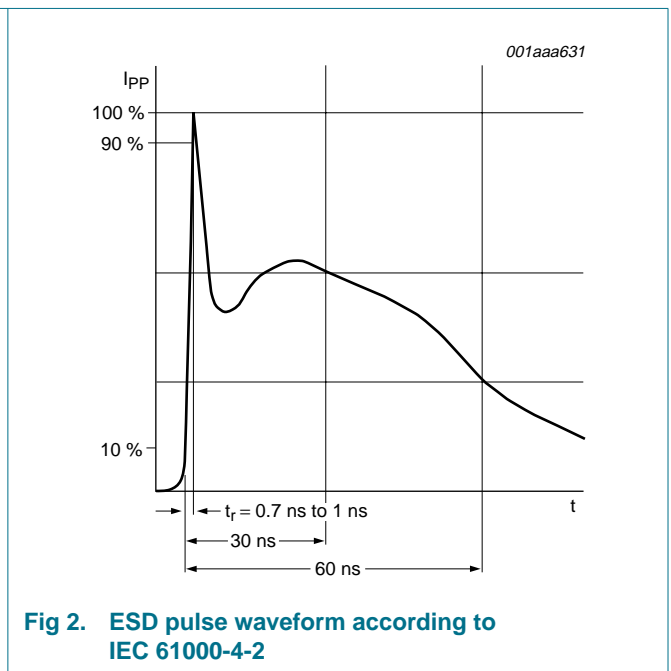
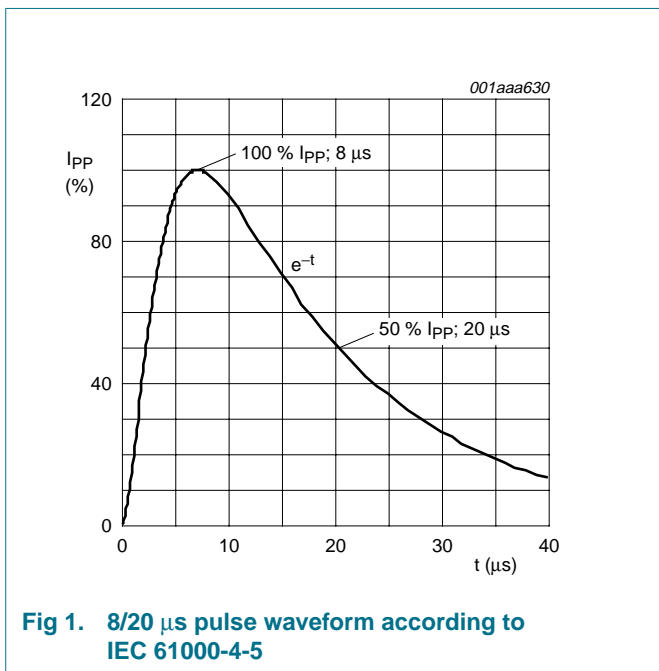

6. Characteristics

Table 9. Characteristics

$T_{amb} = 25\text{ }^{\circ}\text{C}$ unless otherwise specified.

Symbol	Parameter	Conditions	Min	Typ	Max	Unit	
Per diode							
V_{RWM}	reverse standoff voltage						
	PESD3V3V4UF PESD3V3V4UG PESD3V3V4UW		-	-	3.3	V	
	PESD5V0V4UF PESD5V0V4UG PESD5V0V4UW		-	-	5.0	V	
	I_{RM}	reverse leakage current					
		PESD3V3V4UF PESD3V3V4UG PESD3V3V4UW	$V_{RWM} = 3.3\text{ V}$	-	40	300	nA
		PESD5V0V4UF PESD5V0V4UG PESD5V0V4UW	$V_{RWM} = 5.0\text{ V}$	-	3	25	nA
V_{BR}	breakdown voltage	$I_R = 1\text{ mA}$					
	PESD3V3V4UF PESD3V3V4UG PESD3V3V4UW		5.3	5.6	5.9	V	
	PESD5V0V4UF PESD5V0V4UG PESD5V0V4UW		6.4	6.8	7.2	V	
	C_d	diode capacitance	$f = 1\text{ MHz}$				
		PESD3V3V4UF PESD3V3V4UG PESD3V3V4UW	$V_R = 0\text{ V}$	-	15	18	pF
		PESD3V3V4UF PESD3V3V4UG PESD3V3V4UW	$V_R = 3.3\text{ V}$	-	9	12	pF
PESD5V0V4UF PESD5V0V4UG PESD5V0V4UW		$V_R = 0\text{ V}$	-	12	15	pF	
PESD5V0V4UF PESD5V0V4UG PESD5V0V4UW		$V_R = 5\text{ V}$	-	6	9	pF	

Table 9. Characteristics ...continued
 $T_{amb} = 25^{\circ}\text{C}$ unless otherwise specified.

Symbol	Parameter	Conditions	Min	Typ	Max	Unit
V_{CL}	clamping voltage		[1][2][3]			
	PESD3V3V4UF PESD3V3V4UG PESD3V3V4UW	$I_{PP} = 1\text{ A}$	-	-	9	V
	PESD3V3V4UF PESD3V3V4UG PESD3V3V4UW	$I_{PP} = 2\text{ A}$	-	-	11	V
	PESD5V0V4UF PESD5V0V4UG PESD5V0V4UW	$I_{PP} = 1\text{ A}$	-	-	11	V
	PESD5V0V4UF PESD5V0V4UG PESD5V0V4UW	$I_{PP} = 1.7\text{ A}$	-	-	13	V
	r_{dif}	differential resistance	$I_R = 1\text{ mA}$			
PESD3V3V4UF PESD3V3V4UG PESD3V3V4UW			-	-	200	Ω
PESD5V0V4UF PESD5V0V4UG PESD5V0V4UW			-	-	100	Ω

- [1] Non-repetitive current pulse 8/20 μs exponential decay waveform according to IEC 61000-4-5.
- [2] For PESDxV4UF measured from pin 1, 3, 4 or 6 to pin 2 or 5.
- [3] For PESDxV4UG and PESDxV4UW measured from pin 1, 3, 4 or 5 to pin 2.

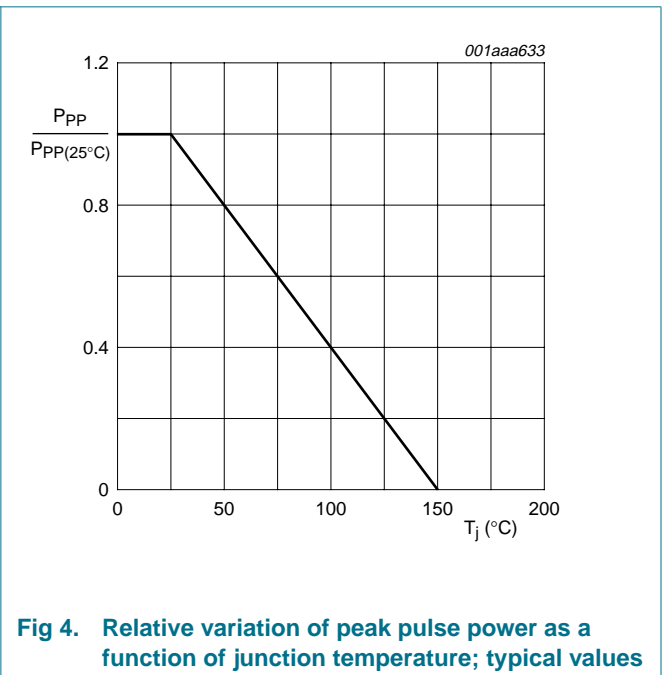
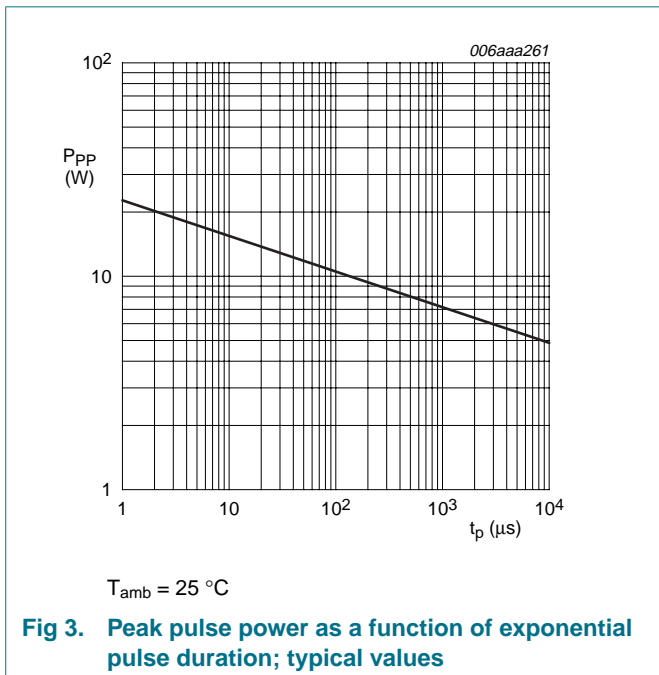

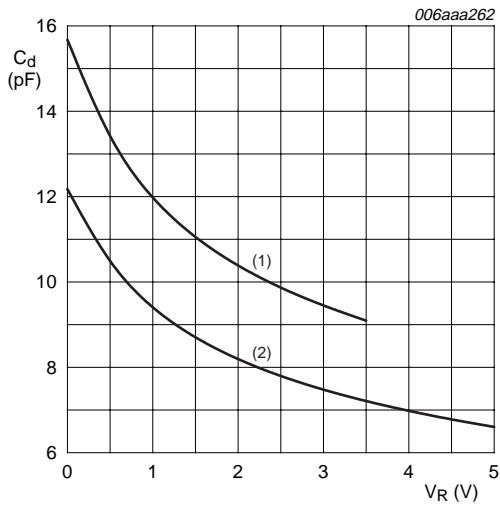

f = 1 MHz; T_{amb} = 25 °C

- (1) PESD3V3V4UF; PESD3V3V4UG; PESD3V3V4UW
- (2) PESD5V0V4UF; PESD5V0V4UG; PESD5V0V4UW

Fig 5. Diode capacitance as a function of reverse voltage; typical values

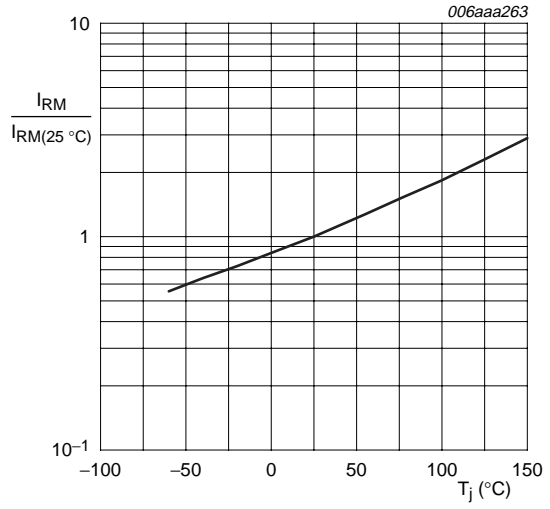

Fig 6. Relative variation of reverse leakage current as a function of junction temperature; typical values

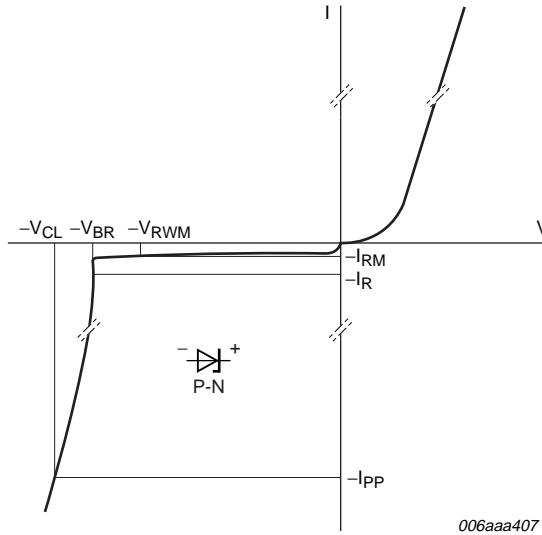

Fig 7. V-I characteristics for a unidirectional ESD protection diode

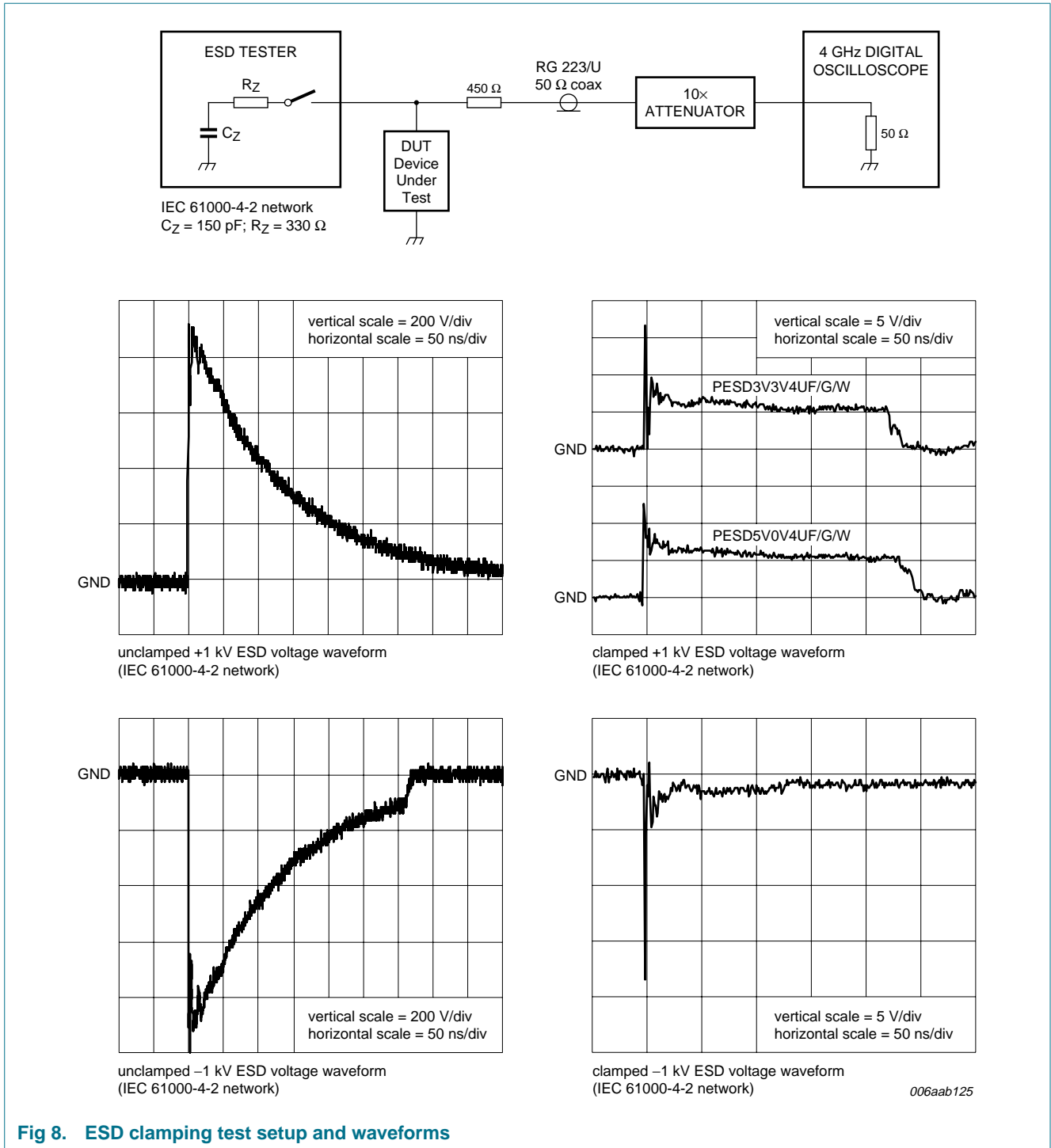
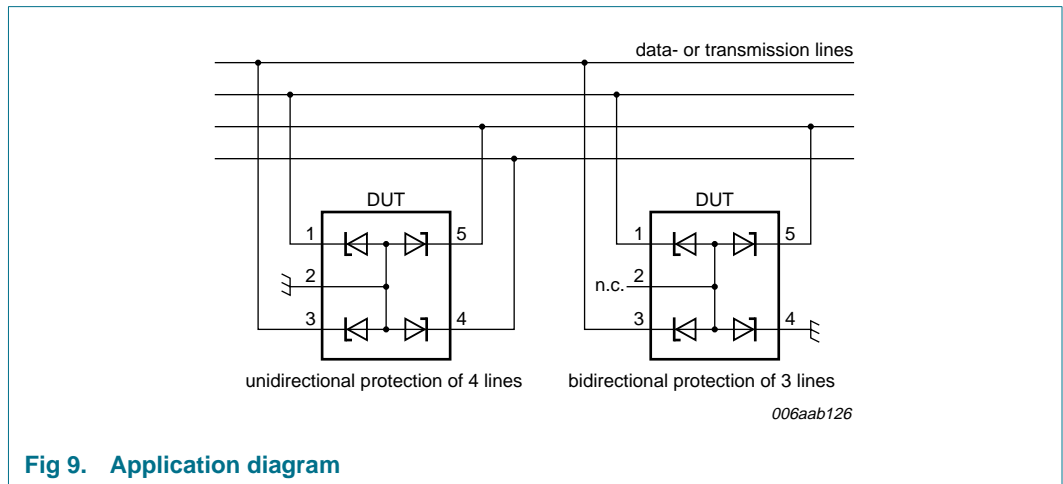

Fig 8. ESD clamping test setup and waveforms

7. Application information

The devices are designed for the protection of up to four unidirectional data or signal lines from the damage caused by ESD and surge pulses. The devices may be used on lines where the signal polarities are both, positive and negative with respect to ground. The devices provide a surge capability of 16 W per line for an 8/20 μ s waveform each.



Circuit board layout and protection device placement

Circuit board layout is critical for the suppression of ESD, Electrical Fast Transient (EFT) and surge transients. The following guidelines are recommended:

1. Place the device as close to the input terminal or connector as possible.
2. The path length between the device and the protected line should be minimized.
3. Keep parallel signal paths to a minimum.
4. Avoid running protected conductors in parallel with unprotected conductors.
5. Minimize all Printed-Circuit Board (PCB) conductive loops including power and ground loops.
6. Minimize the length of the transient return path to ground.
7. Avoid using shared transient return paths to a common ground point.
8. Ground planes should be used whenever possible. For multilayer PCBs, use ground vias.

8. Package outline

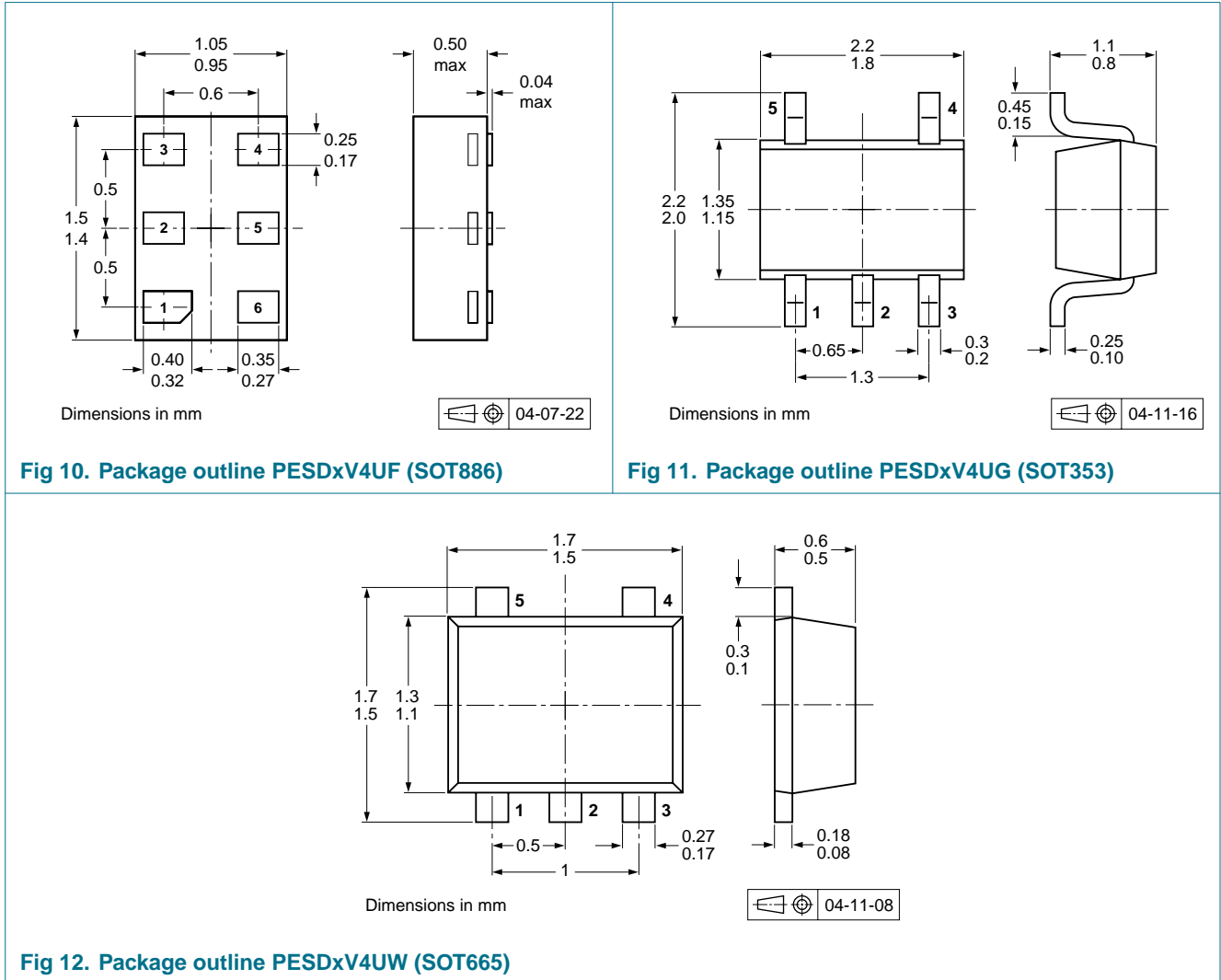

9. Packing information

Table 10. Packing methods

The indicated -xxx are the last three digits of the 12NC ordering code.^[1]

Type number	Package	Description	Packing quantity					
			3000	4000	5000	8000	10000	
PESD3V3V4UF	SOT886	4 mm pitch, 8 mm tape and reel; T1	[2]	-	-	-115	-	-
		4 mm pitch, 8 mm tape and reel; T4	[3]	-	-	-132	-	-
PESD5V0V4UF	SOT886	4 mm pitch, 8 mm tape and reel; T1	[2]	-	-	-115	-	-
		4 mm pitch, 8 mm tape and reel; T4	[3]	-	-	-132	-	-
PESD3V3V4UG	SOT353	4 mm pitch, 8 mm tape and reel; T1	[2]	-115	-	-	-	-135
		4 mm pitch, 8 mm tape and reel; T2	[4]	-125	-	-	-	-165
PESD5V0V4UG	SOT353	4 mm pitch, 8 mm tape and reel; T1	[2]	-115	-	-	-	-135
		4 mm pitch, 8 mm tape and reel; T2	[4]	-125	-	-	-	-165
PESD3V3V4UW	SOT665	2 mm pitch, 8 mm tape and reel	-	-	-	-	-315	-
		4 mm pitch, 8 mm tape and reel	-	-115	-	-	-	-
PESD5V0V4UW	SOT665	2 mm pitch, 8 mm tape and reel	-	-	-	-	-315	-
		4 mm pitch, 8 mm tape and reel	-	-115	-	-	-	-

[1] For further information and the availability of packing methods, see [Section 13](#).

[2] T1: normal taping

[3] T4: 90° rotated reverse taping

[4] T2: reverse taping

10. Soldering

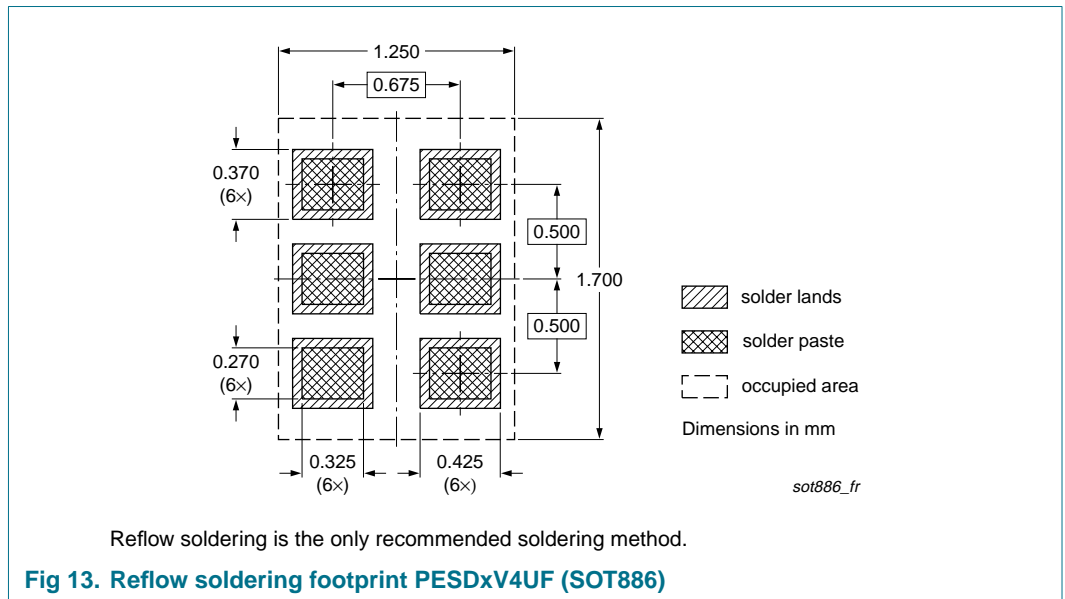

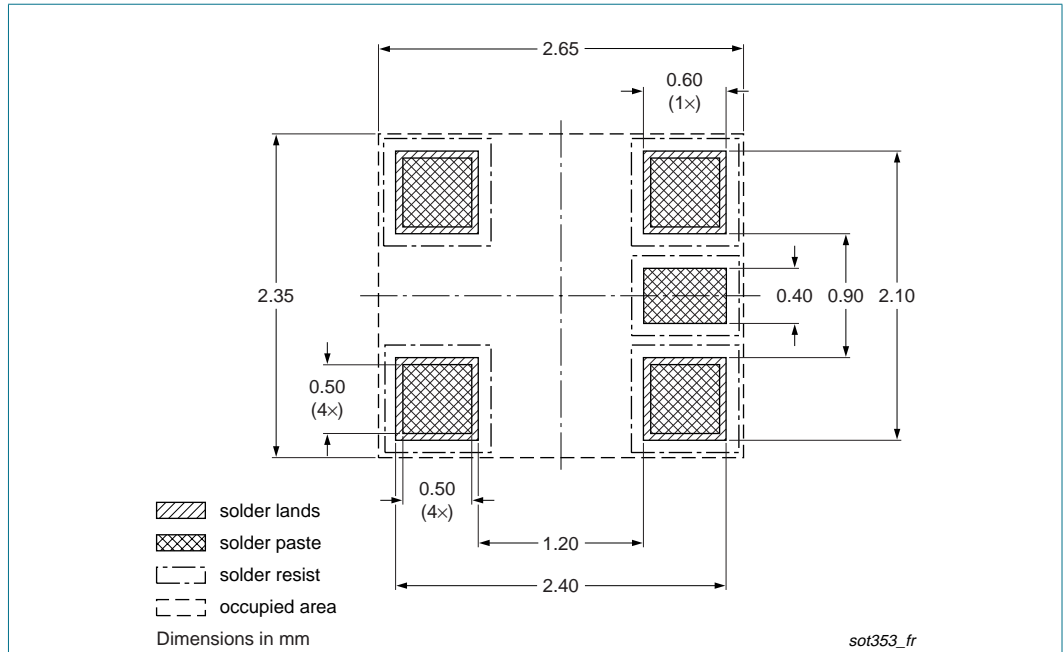

Fig 14. Reflow soldering footprint PESDxV4UG (SOT353/SC-88A)

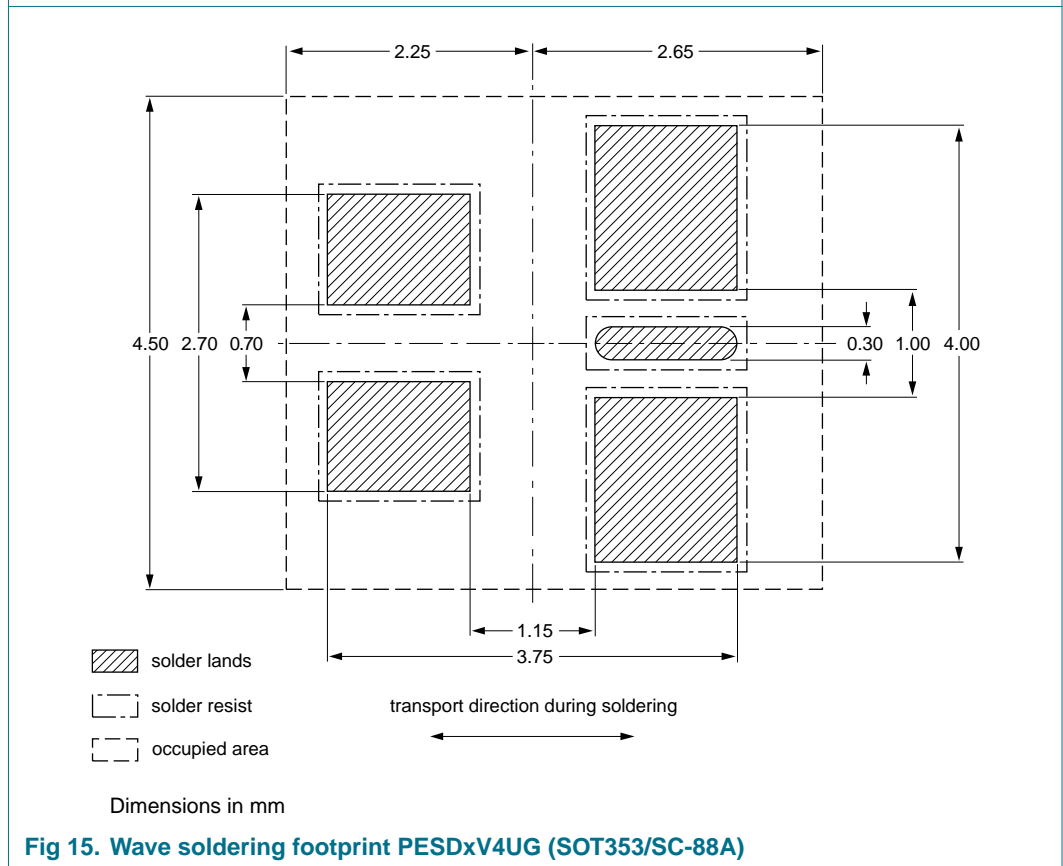
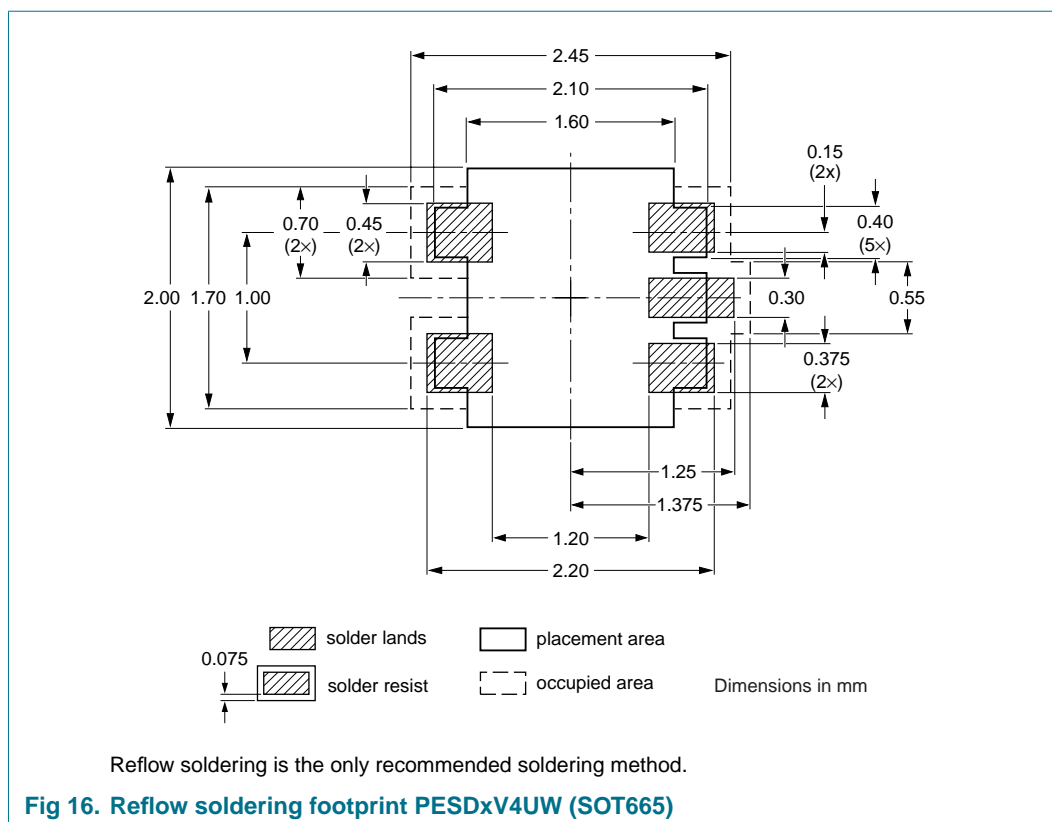

Fig 15. Wave soldering footprint PESDxV4UG (SOT353/SC-88A)



11. Revision history

Table 11. Revision history

Document ID	Release date	Data sheet status	Change notice	Supersedes
PESDXV4UF_G_W_3	20080128	Product data sheet	-	PESDXV4UG_SER_2 PESDXV4UW_SER_1
Modifications:		<ul style="list-style-type: none"> • The format of this data sheet has been redesigned to comply with the new identity guidelines of NXP Semiconductors. • Legal texts have been adapted to the new company name where appropriate. • Type numbers PESD3V3V4UF and PESD5V0V4UF added • Table 1 “Product overview”: added • Figure 7: added • Section 9 “Packing information”: added • Section 10 “Soldering”: added • Section 12 “Legal information”: updated 		
PESDXV4UG_SER_2	20050407	Product data sheet	-	PESDXV4UG_SER_1
PESDXV4UW_SER_1	20050422	Product data sheet	-	-

12. Legal information

12.1 Data sheet status

Document status ^{[1][2]}	Product status ^[3]	Definition
Objective [short] data sheet	Development	This document contains data from the objective specification for product development.
Preliminary [short] data sheet	Qualification	This document contains data from the preliminary specification.
Product [short] data sheet	Production	This document contains the product specification.

[1] Please consult the most recently issued document before initiating or completing a design.

[2] The term 'short data sheet' is explained in section "Definitions".

[3] The product status of device(s) described in this document may have changed since this document was published and may differ in case of multiple devices. The latest product status information is available on the Internet at URL <http://www.nxp.com>.

12.2 Definitions

Draft — The document is a draft version only. The content is still under internal review and subject to formal approval, which may result in modifications or additions. NXP Semiconductors does not give any representations or warranties as to the accuracy or completeness of information included herein and shall have no liability for the consequences of use of such information.

Short data sheet — A short data sheet is an extract from a full data sheet with the same product type number(s) and title. A short data sheet is intended for quick reference only and should not be relied upon to contain detailed and full information. For detailed and full information see the relevant full data sheet, which is available on request via the local NXP Semiconductors sales office. In case of any inconsistency or conflict with the short data sheet, the full data sheet shall prevail.

12.3 Disclaimers

General — Information in this document is believed to be accurate and reliable. However, NXP Semiconductors does not give any representations or warranties, expressed or implied, as to the accuracy or completeness of such information and shall have no liability for the consequences of use of such information.

Right to make changes — NXP Semiconductors reserves the right to make changes to information published in this document, including without limitation specifications and product descriptions, at any time and without notice. This document supersedes and replaces all information supplied prior to the publication hereof.

Suitability for use — NXP Semiconductors products are not designed, authorized or warranted to be suitable for use in medical, military, aircraft, space or life support equipment, nor in applications where failure or

malfunction of an NXP Semiconductors product can reasonably be expected to result in personal injury, death or severe property or environmental damage. NXP Semiconductors accepts no liability for inclusion and/or use of NXP Semiconductors products in such equipment or applications and therefore such inclusion and/or use is at the customer's own risk.

Applications — Applications that are described herein for any of these products are for illustrative purposes only. NXP Semiconductors makes no representation or warranty that such applications will be suitable for the specified use without further testing or modification.

Limiting values — Stress above one or more limiting values (as defined in the Absolute Maximum Ratings System of IEC 60134) may cause permanent damage to the device. Limiting values are stress ratings only and operation of the device at these or any other conditions above those given in the Characteristics sections of this document is not implied. Exposure to limiting values for extended periods may affect device reliability.

Terms and conditions of sale — NXP Semiconductors products are sold subject to the general terms and conditions of commercial sale, as published at <http://www.nxp.com/profile/terms>, including those pertaining to warranty, intellectual property rights infringement and limitation of liability, unless explicitly otherwise agreed to in writing by NXP Semiconductors. In case of any inconsistency or conflict between information in this document and such terms and conditions, the latter will prevail.

No offer to sell or license — Nothing in this document may be interpreted or construed as an offer to sell products that is open for acceptance or the grant, conveyance or implication of any license under any copyrights, patents or other industrial or intellectual property rights.

12.4 Trademarks

Notice: All referenced brands, product names, service names and trademarks are the property of their respective owners.

13. Contact information

For additional information, please visit: <http://www.nxp.com>

For sales office addresses, send an email to: salesaddresses@nxp.com

14. Contents

1	Product profile	1
1.1	General description	1
1.2	Features	1
1.3	Applications	1
1.4	Quick reference data	2
2	Pinning information	2
3	Ordering information	3
4	Marking	3
5	Limiting values	3
6	Characteristics	5
7	Application information	9
8	Package outline	10
9	Packing information	11
10	Soldering	11
11	Revision history	14
12	Legal information	15
12.1	Data sheet status	15
12.2	Definitions	15
12.3	Disclaimers	15
12.4	Trademarks	15
13	Contact information	15
14	Contents	16



Please be aware that important notices concerning this document and the product(s) described herein, have been included in section 'Legal information'.

© NXP B.V. 2008.

All rights reserved.

For more information, please visit: <http://www.nxp.com>

For sales office addresses, please send an email to: salesaddresses@nxp.com

Date of release: 28 January 2008

Document identifier: PESDXV4UF_G_W_3