

# NUD4700

## LED Shunt

The NUD4700 is an electronic shunt which provides a current bypass in the case of a single LED going into open circuit. LEDs are by nature quite fragile when subjected to transients and surge conditions. There are also many cases where high reliability of the LED lighting must be maintained such as headlights, lighthouses, bridges, aircraft, runways and so forth. In these cases the low cost addition of the NUD4700 will provide full assurance that an entire string of LEDs will not extinguish should one LED fail. NUD4700 is also applicable to other loads where circuit continuity is required. This device is designed to be used with 1 W LEDs (nominally 350 mA @ 3 V).

### Features

- A Simple Two Terminal Device
- Automatically Resets Itself if the LED Heals Itself or is Replaced
- ON-State Voltage Typically 1 V
- OFF-State Current less than 250  $\mu$ A
- This is a Pb-Free Device

### Typical Applications

- LEDs where Preventive Maintenance is Non Practical
- LED Headlights
- LEDs with High Reliability Requirements
- Crowbar Protection for Open Circuit Conditions
- Overvoltage Protection for Sensitive Circuits



**ON Semiconductor®**

<http://onsemi.com>

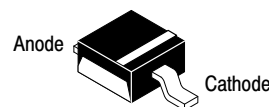
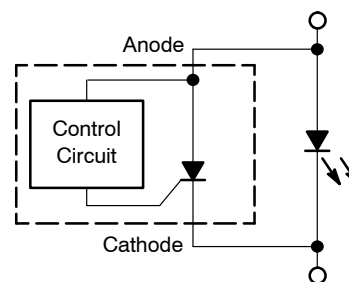

**POWERMITE®  
CASE 457  
PLASTIC**

### MARKING DIAGRAM

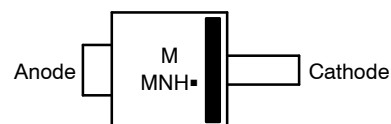

M = Date Code  
MNH = Device Code  
▪ = Pb-Free Package

### PIN FUNCTION DESCRIPTION

| Pin     | Description                          |
|---------|--------------------------------------|
| Anode   | Positive Input Voltage to the Device |
| Cathode | Negative Input Voltage to the Device |

### ORDERING INFORMATION

| Device       | Package             | Shipping†        |
|--------------|---------------------|------------------|
| NUD4700SNT1G | POWERMITE (Pb-Free) | 3000/Tape & Reel |

†For information on tape and reel specifications, including part orientation and tape sizes, please refer to our Tape and Reel Packaging Specifications Brochure, BRD8011/D.

# NUD4700

**MAXIMUM RATINGS** (Maximum ratings are those, that, if exceeded, may cause damage to the device. Electrical Characteristics are not guaranteed over this range)

| Rating  | Symbol       | Value        | Unit                      |
|---|--------------|--------------|---------------------------|
| Peak Repetitive Off State Voltage (Anode to Cathode)                            | $V_{DM}$     | -0.3 to 10   | V                         |
| Average On-State Current, ( $T_A = 25^\circ\text{C}$ ),<br>(Note 1)<br>(Note 2) | $I_{T(AVG)}$ | 1.3<br>0.376 | A                         |
| Thermal Resistance, Junction-to-Air<br>(Note 1)<br>(Note 2)                     | $Q_{JA}$     | 80<br>277    | $^\circ\text{C}/\text{W}$ |
| Thermal Resistance, Junction-to-Lead  | $Q_{JL}$     | 35           | $^\circ\text{C}/\text{W}$ |
| Power Dissipation ( $T_A = 25^\circ\text{C}$ )<br>(Note 1)<br>(Note 2)          | $P_{MAX}$    | 1.56<br>0.45 | W                         |
| Operating Temperature Range   | $T_J$        | -40 to 150   | $^\circ\text{C}$          |
| Non-Operating Temperature Range   | $T_J$        | 150          | $^\circ\text{C}$          |
| Lead Temperature, Soldering (10 Sec)  | $T_L$        | 260          | $^\circ\text{C}$          |

Stresses exceeding Maximum Ratings may damage the device. Maximum Ratings are stress ratings only. Functional operation above the Recommended Operating Conditions is not implied. Extended exposure to stresses above the Recommended Operating Conditions may affect device reliability.

1. Mounted onto a 1" x 1" square copper pad.

Normally this device would be mounted on the same copper heat sink and adjacent to the LED. If the LED were to go open, then the NUD4700 shunt would now dissipate the power using the same copper heat sink. Since the NUD4700 has a voltage that is nominally 30% of the LED, then the power dissipation would be easily handled by the same heat sink as the LED.

2. Device mounted on minimum copper pad.

## ELECTRICAL CHARACTERISTICS (Unless otherwise noted: $T_A = 25^\circ\text{C}$ )

| Characteristics  | Symbol     | Min         | Typ               | Max           | Unit          |
|--|------------|-------------|-------------------|---------------|---------------|
| Off-State Current<br>( $V_{Anode} = 5\text{ V}$ )  | $I_{LEAK}$ | -           | 100               | 250           | $\mu\text{A}$ |
| Breakdown Voltage<br>( $I_{BR} = 1\text{ mA}$ )  | $V_{(BR)}$ | 5.5         | -                 | 7.5           | V             |
| Holding Current<br>( $V_{Anode} = 10\text{ V}$ , $I_{initial} = 100\text{ mA}$ )                         | $I_H$      | -           | 6.0               | 12            | mA            |
| Latching Current<br>( $V_{Anode} = 10\text{ V}$ )  | $I_L$      | -           | 35                | 70            | mA            |
| On-State Voltage<br>( $I_T = 0.350\text{ A}$ )<br>( $I_T = 0.750\text{ A}$ )<br>( $I_T = 1.0\text{ A}$ ) | $V_T$      | -<br>-<br>- | 1.0<br>1.0<br>1.0 | 1.2<br>-<br>- | V             |

## DYNAMIC CHARACTERISTICS

|   |       |     |   |   |                  |
|---|-------|-----|---|---|------------------|
| Critical Rate-of-Rise of Off State Voltage<br>( $V_{pk} = \text{Rated } V_{(BR)}$ , $T_J = 125^\circ\text{C}$ , Exponential Method) | dV/dt | 250 | - | - | V/ $\mu\text{s}$ |
|---|-------|-----|---|---|------------------|

# NUD4700

## TYPICAL PERFORMANCE CURVES

( $T_A = 25^\circ\text{C}$  unless otherwise noted)

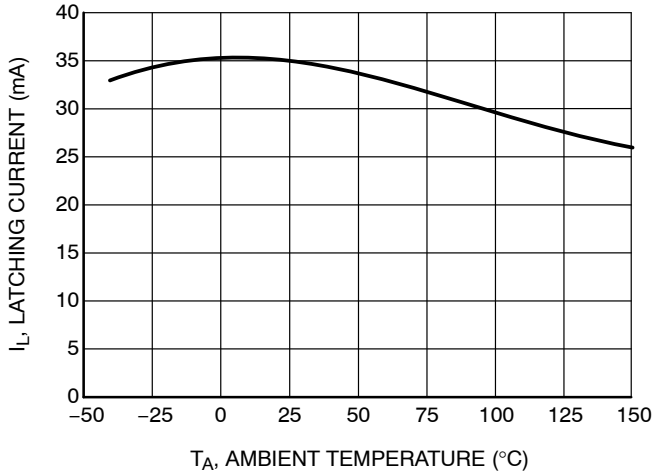

**Figure 1. Latching Current vs Temperature**

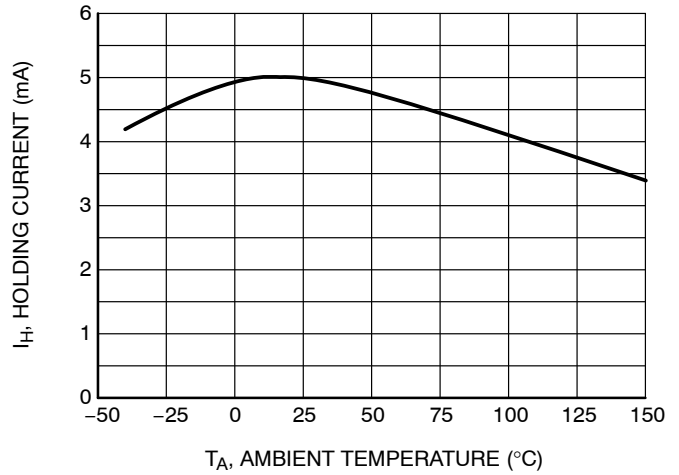

**Figure 2. Holding Current vs Temperature**

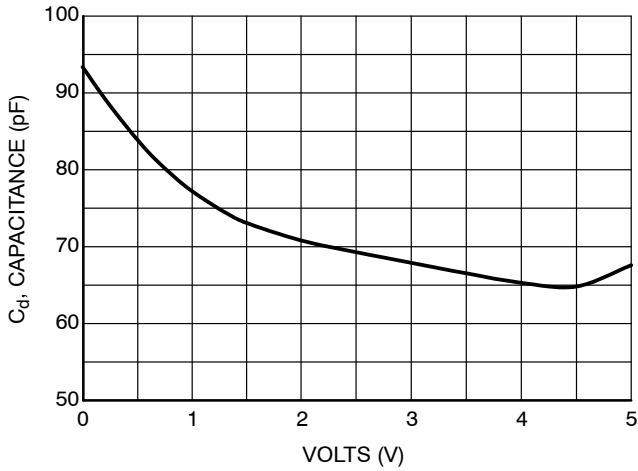

**Figure 3. Capacitance vs Voltage**

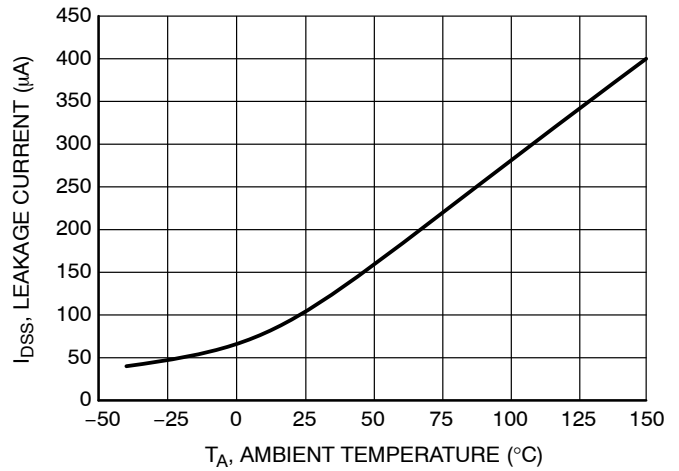

**Figure 4. Leakage Current vs Temperature**

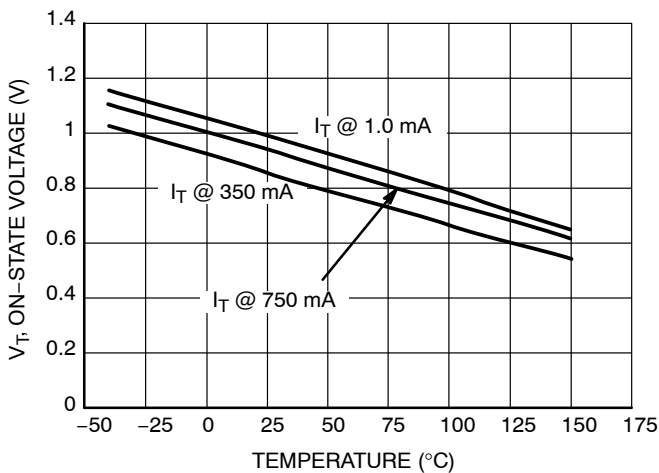

**Figure 5. On-State Voltage vs. Temperature**

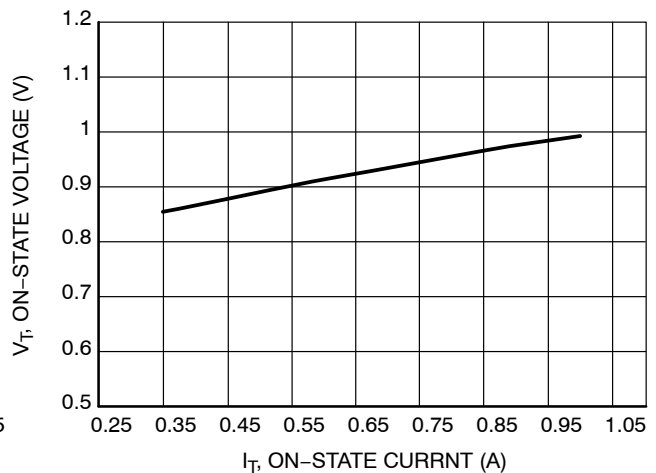

**Figure 6. On-State Voltage vs. On-State Current ( $I_T$ ) at  $25^\circ\text{C}$**

# NUD4700

## TYPICAL APPLICATION CIRCUIT

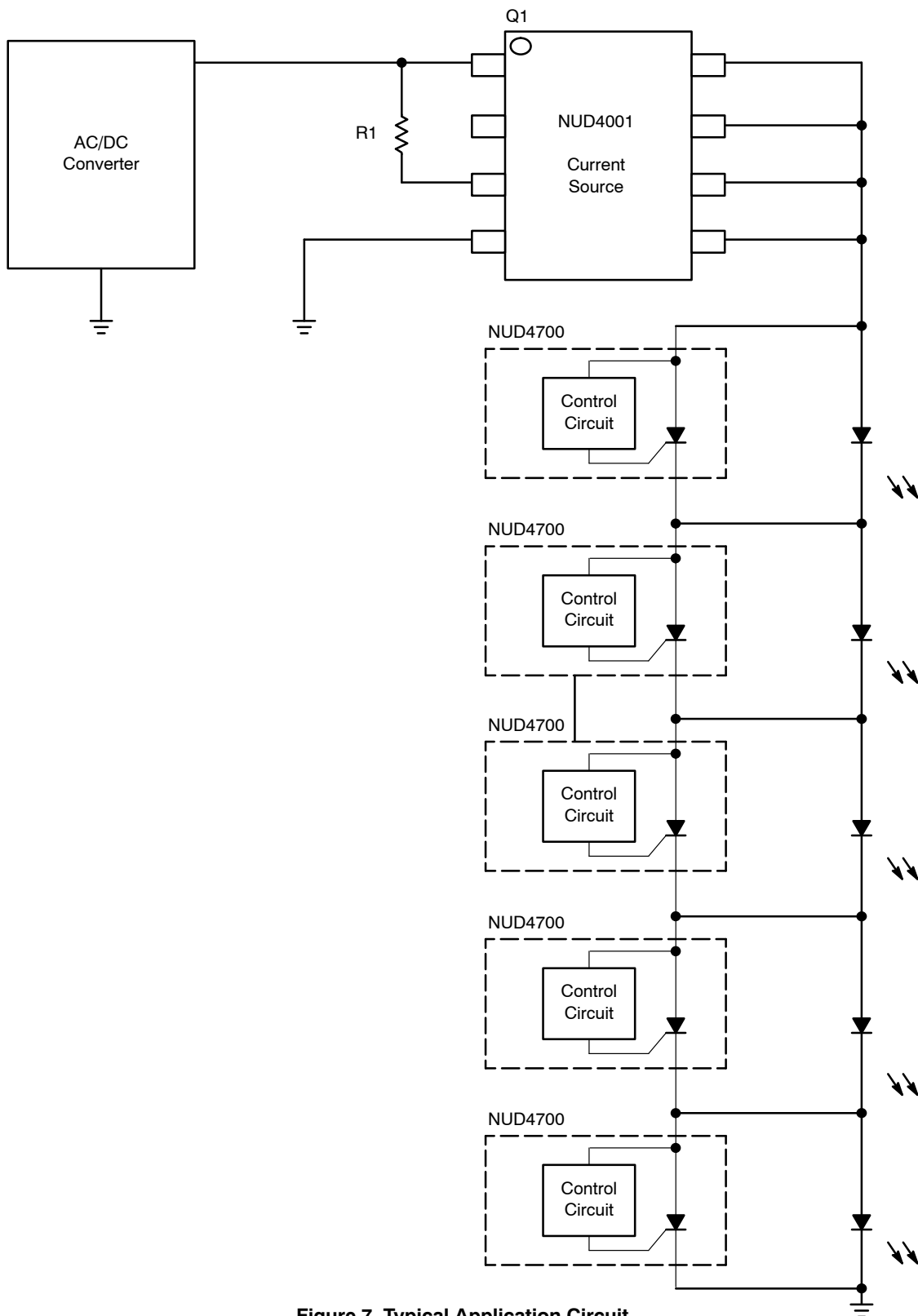

Figure 7. Typical Application Circuit

# NUD4700

## TYPICAL OPERATION WAVEFORMS

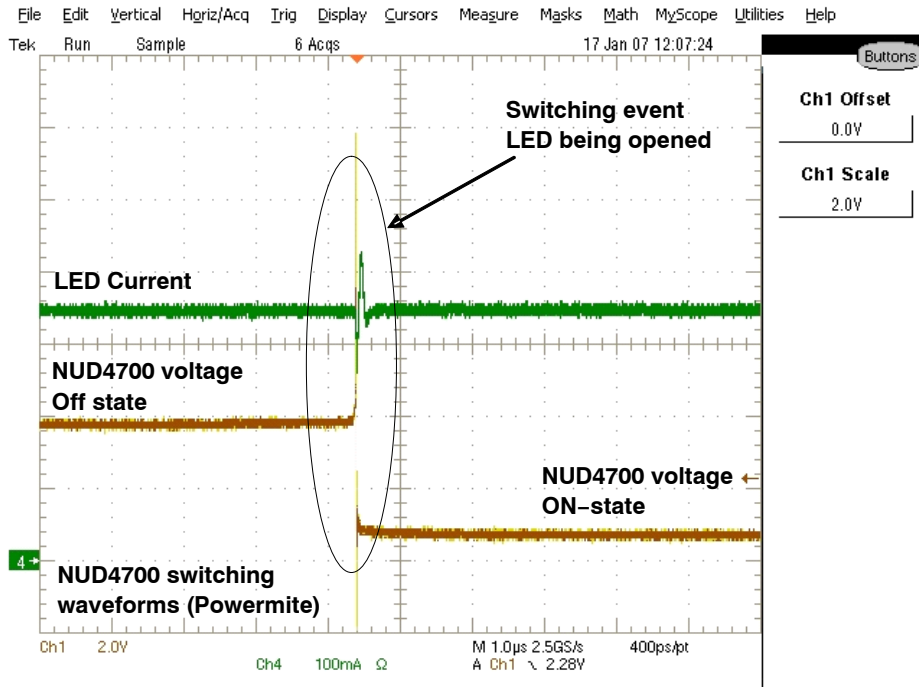

Figure 8. NUD4700 Switching Waveforms

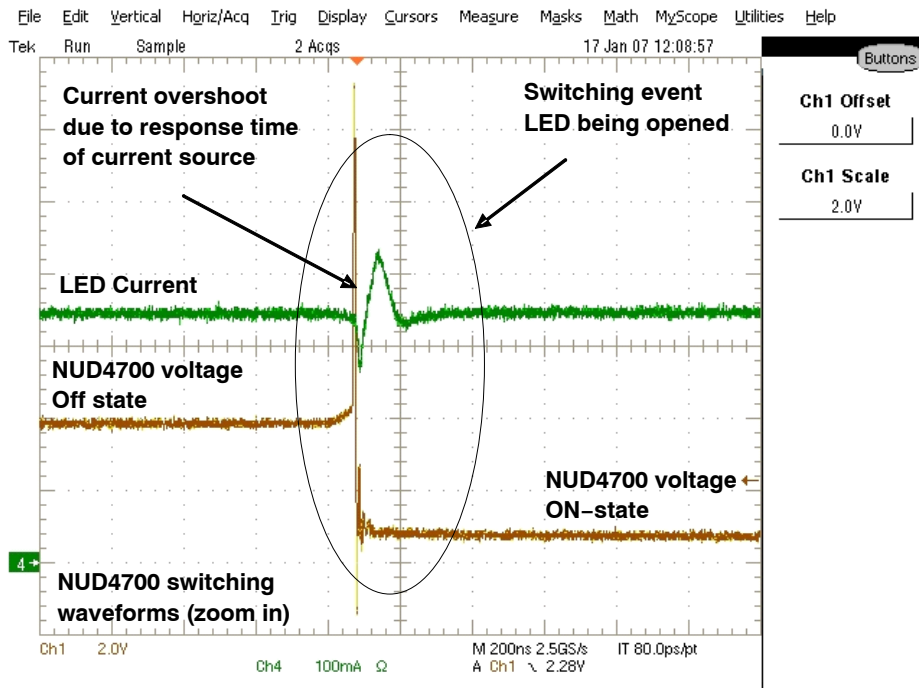
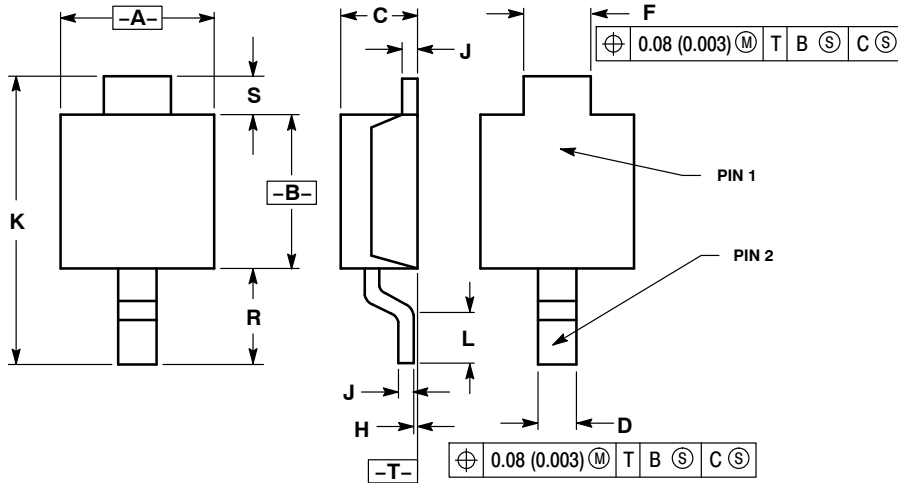

Figure 9. Zoom in of Figure 8

# NUD4700

## PACKAGE DIMENSIONS

POWERMITE  
CASE 457-04  
ISSUE E



### NOTES:

- DIMENSIONING AND TOLERANCING PER ANSI Y14.5M, 1982.
- CONTROLLING DIMENSION: MILLIMETER.
- DIMENSION A DOES NOT INCLUDE MOLD FLASH, PROTRUSIONS OR GATE BURRS. MOLD FLASH, PROTRUSIONS OR GATE BURRS SHALL NOT EXCEED 0.15 (0.006) PER SIDE.

| DIM | MILLIMETERS |       | INCHES    |        |
|-----|-------------|-------|-----------|--------|
|     | MIN         | MAX   | MIN       | MAX    |
| A   | 1.75        | 2.05  | 0.069     | 0.081  |
| B   | 1.75        | 2.18  | 0.069     | 0.086  |
| C   | 0.85        | 1.15  | 0.033     | 0.045  |
| D   | 0.40        | 0.69  | 0.016     | 0.027  |
| F   | 0.70        | 1.00  | 0.028     | 0.039  |
| H   | -0.05       | +0.10 | -0.002    | +0.004 |
| J   | 0.10        | 0.25  | 0.004     | 0.010  |
| K   | 3.60        | 3.90  | 0.142     | 0.154  |
| L   | 0.50        | 0.80  | 0.020     | 0.031  |
| R   | 1.20        | 1.50  | 0.047     | 0.059  |
| S   | 0.50 REF    |       | 0.019 REF |        |

### SOLDERING FOOTPRINT\*

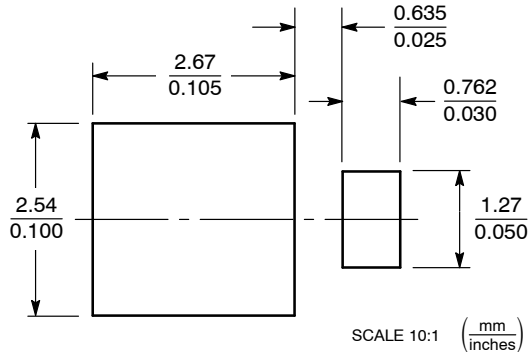

\*For additional information on our Pb-Free strategy and soldering details, please download the ON Semiconductor Soldering and Mounting Techniques Reference Manual, SOLDERRM/D.

POWERMITE is a registered trademark of and used under a license from Microsemi Corporation.

The product described herein (NUD4700), may be covered by one or more U.S. patents. There may be other patents pending.

ON Semiconductor and are registered trademarks of Semiconductor Components Industries, LLC (SCILLC). SCILLC reserves the right to make changes without further notice to any products herein. SCILLC makes no warranty, representation or guarantee regarding the suitability of its products for any particular purpose, nor does SCILLC assume any liability arising out of the application or use of any product or circuit, and specifically disclaims any and all liability, including without limitation special, consequential or incidental damages. "Typical" parameters which may be provided in SCILLC data sheets and/or specifications can and do vary in different applications and actual performance may vary over time. All operating parameters, including "Typicals" must be validated for each customer application by customer's technical experts. SCILLC does not convey any license under its patent rights nor the rights of others. SCILLC products are not designed, intended, or authorized for use as components in systems intended for surgical implant into the body, or other applications intended to support or sustain life, or for any other application in which the failure of the SCILLC product could create a situation where personal injury or death may occur. Should Buyer purchase or use SCILLC products for any such unintended or unauthorized application, Buyer shall indemnify and hold SCILLC and its officers, employees, subsidiaries, affiliates, and distributors harmless against all claims, costs, damages, and expenses, and reasonable attorney fees arising out of, directly or indirectly, any claim of personal injury or death associated with such unintended or unauthorized use, even if such claim alleges that SCILLC was negligent regarding the design or manufacture of the part. SCILLC is an Equal Opportunity/Affirmative Action Employer. This literature is subject to all applicable copyright laws and is not for resale in any manner.

### PUBLICATION ORDERING INFORMATION

#### LITERATURE FULFILLMENT:

Literature Distribution Center for ON Semiconductor  
P.O. Box 5163, Denver, Colorado 80217 USA  
Phone: 303-675-2175 or 800-344-3860 Toll Free USA/Canada  
Fax: 303-675-2176 or 800-344-3867 Toll Free USA/Canada  
Email: orderlit@onsemi.com

N. American Technical Support: 800-282-9855 Toll Free  
USA/Canada  
Europe, Middle East and Africa Technical Support:  
Phone: 421 33 790 2910  
Japan Customer Focus Center  
Phone: 81-3-5773-3850

ON Semiconductor Website: [www.onsemi.com](http://www.onsemi.com)

Order Literature: <http://www.onsemi.com/orderlit>

For additional information, please contact your local Sales Representative