



## Film Capacitors

### Metallized Polypropylene Film Capacitors (MKP)

**Series/Type:** B32671L ... B32672L

**Date:** December 2012

**Typical applications**

- Electronic ballasts (resonant circuits)
- SMPS
- High-frequency AC loads
- Pulse circuits

**Climatic**

- Max. operating temperature: 125 °C
- Climatic category (IEC 60068-1): 55/110/56

**Construction**

- Dielectric: metallized polypropylene (PP)
- Wound capacitor technology
- Plastic case (UL 94 V-0)
- Epoxy resin sealing

**Features**

- Very high AC voltages for all frequency ranges
- Very small dimensions
- High peak voltage for short time periods
- High peak current
- High pulse withstand capability
- RoHS-compatible
- Halogen-free capacitors available on request

**Terminals**

- Parallel wire leads, lead-free tinned
- Special lead lengths available on request

**Marking**

- Manufacturer's logo
- lot number, series number
- Rated capacitance (coded)
- Capacitance tolerance (code letter)
- Rated AC voltage
- Date of manufacture (coded)

**Delivery mode**

- Bulk (untaped)
- Taped (Ammo pack or reel)

For notes on taping, refer to chapter "Taping and packing".

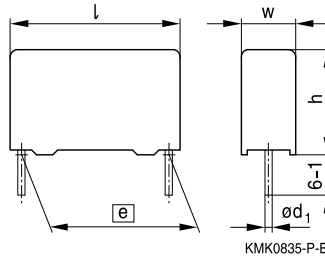
**Dimensional drawing**

Dimensions in mm

Lead spacing	Lead diameter	Type
$e \pm 0.4$	$d_1$	
10	0.6	B32671L
15	0.8	B32672L

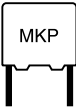

Overview of available types

Lead spacing	10 mm						15 mm							
Type	B32671L						B32672L							
Page	4						6							
$V_{RMS}$ (V AC)	200	250	250	500	600	700	160	200	250	250	500	600	700	900
$V_R$ (V DC)	400	630	1000	1000	1600	2000	250	420	630	1000	1300	1600	2000	2000
$C_R$ (nF)														
0.68														
1.0														
1.2														
1.5														
2.2														
2.7														
3.3														
3.9														
4.7														
5.6														
6.2														
6.8														
8.2														
10														
12														
15														
22														
33														
47														
56														
68														
100														
150														
220														
330														
390														
470														
680														
1000														

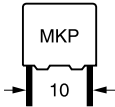
**B32671L**
**High V AC, high temperature (wound)**
**Ordering codes and packing units (lead spacing 10 mm)**

$V_{RMS}$ $f \leq 1$ kHz V AC	$V_R$ V DC	$C_R$ nF	Max. dimensions $w \times h \times l$ mm	Ordering code (composition see below)	Ammo pack pcs./MOQ	Reel pcs./ MOQ	Untaped pcs./ MOQ
200	400	22	4.0 × 9.0 × 13.0	B32671L4223+***	4000	6800	4000
		33	4.0 × 9.0 × 13.0	B32671L4333+***	4000	6800	4000
		47	5.0 × 11.0 × 13.0	B32671L4473+***	3320	5200	4000
		68	5.0 × 11.0 × 13.0	B32671L4683+***	3320	5200	4000
		100	6.0 × 12.0 × 13.0	B32671L4104+***	2720	4400	4000
250	630	15	4.0 × 9.0 × 13.0	B32671L6153+***	4000	6800	4000
		22	5.0 × 11.0 × 13.0	B32671L6223+***	3320	5200	4000
		33	5.0 × 11.0 × 13.0	B32671L6333+***	3320	5200	4000
		47	6.0 × 12.0 × 13.0	B32671L6473+***	2720	4400	4000
		56	6.0 × 12.0 × 13.0	B32671L6563+***	2720	4400	4000
250	1000	4.7	4.0 × 9.0 × 13.0	B32671L9472+***	4000	6800	4000
		6.8	4.0 × 9.0 × 13.0	B32671L9682+***	4000	6800	4000
		10	5.0 × 11.0 × 13.0	B32671L9103+***	3320	5200	4000
		15	5.0 × 11.0 × 13.0	B32671L9153+***	3320	5200	4000
		22	6.0 × 12.0 × 13.0	B32671L9223+***	2720	4400	4000
500	1000	3.3	4.0 × 9.0 × 13.0	B32671L0332+***	4000	6800	4000
		3.9	4.0 × 9.0 × 13.0	B32671L0392+***	4000	6800	4000
		4.7	4.0 × 9.0 × 13.0	B32671L0472+***	4000	6800	4000
		5.6	5.0 × 11.0 × 13.0	B32671L0562+***	3320	5200	4000
		6.2	5.0 × 11.0 × 13.0	B32671L0622+***	3320	5200	4000
		6.8	5.0 × 11.0 × 13.0	B32671L0682+***	3320	5200	4000
		8.2	6.0 × 12.0 × 13.0	B32671L0822+***	3320	5200	4000
		10	6.0 × 12.0 × 13.0	B32671L0103+***	2720	4400	4000
		12	6.0 × 12.0 × 13.0	B32671L0123+***	2720	4400	4000

MOQ = Minimum Order Quantity, consisting of 4 packing units.

Further E series, intermediate capacitance values and closer tolerances on request.

**Composition of ordering code**

+ = Capacitance tolerance code:

K = ±10%

J = ±5%

\*\*\* = Packaging code:

289 = Ammo pack

189 = Reel

000 = Untaped (lead length 6 – 1 mm)

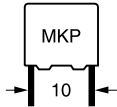
**Ordering codes and packing units (lead spacing 10 mm)**

$V_{RMS}$ f ≤ 1 kHz V AC	$V_R$ V DC	$C_R$ nF	Max. dimensions w × h × l mm	Ordering code (composition see below)	Ammo pack pcs./MOQ	Reel pcs./ MOQ	Untaped pcs./ MOQ
600	1600	1.2	4.0 × 9.0 × 13.0	B32671L1122+***	4000	6800	4000
		1.5	4.0 × 9.0 × 13.0	B32671L1152+***	4000	6800	4000
		2.2	5.0 × 11.0 × 13.0	B32671L1222+***	3320	5200	4000
		2.7	5.0 × 11.0 × 13.0	B32671L1272+***	3320	5200	4000
		3.3	6.0 × 12.0 × 13.0	B32671L1332+***	2720	4400	4000
		3.9	6.0 × 12.0 × 13.0	B32671L1392+***	2720	4400	4000
		4.7	6.0 × 12.0 × 13.0	B32671L1472+***	2720	4400	4000
700	2000	1.0	4.0 × 9.0 × 13.0	B32671L8102+***	4000	6800	4000
		1.2	4.0 × 9.0 × 13.0	B32671L8122+***	4000	6800	4000
		1.5	4.0 × 9.0 × 13.0	B32671L8152+***	4000	6800	4000
		2.2	5.0 × 11.0 × 13.0	B32671L8222+***	3320	5200	4000
		2.7	5.0 × 11.0 × 13.0	B32671L8272+***	3320	5200	4000
		3.3	5.0 × 11.0 × 13.0	B32671L8332+***	3320	5200	4000
		3.9	6.0 × 12.0 × 13.0	B32671L8392+***	2720	4400	4000
		4.7	6.0 × 12.0 × 13.0	B32671L8472+***	2720	4400	4000

MOQ = Minimum Order Quantity, consisting of 4 packing units.

Further E series, intermediate capacitance values and closer tolerances on request.

**Composition of ordering code**

+ = Capacitance tolerance code:

K = ±10%

J = ±5%

\*\*\* = Packaging code:

289 = Ammo pack

189 = Reel

000 = Untaped (lead length 6 – 1 mm)

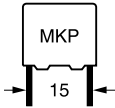
**B32672L**
**High V AC, high temperature (wound)**
**Ordering codes and packing units (lead spacing 15 mm)**

$V_{RMS}$ $f \leq 1$ kHz V AC	$V_R$ V DC	$C_R$ nF	Max. dimensions $w \times h \times l$ mm	Ordering code (composition see below)	Ammo pack pcs./MOQ	Reel pcs./ MOQ	Untaped pcs./ MOQ
160	250	150	5.0 × 10.5 × 18.0	B32672L2154+***	4680	5200	4000
		220	6.0 × 11.0 × 18.0	B32672L2224+***	3840	4400	4000
		330	7.0 × 12.5 × 18.0	B32672L2334+***	3320	3600	4000
		470	8.5 × 14.5 × 18.0	B32672L2474+***	2720	2800	2000
		680	9.0 × 17.5 × 18.0	B32672L2684+***	2560	2800	2000
		1000	11.0 × 18.5 × 18.0	B32672L2105+***	–	2200	1000
200	420	68	5.0 × 10.5 × 18.0	B32672L4683+***	4680	5200	4000
		100	5.0 × 10.5 × 18.0	B32672L4104+***	4680	5200	4000
		150	6.0 × 11.0 × 18.0	B32672L4154+***	3840	4400	4000
		220	7.0 × 12.5 × 18.0	B32672L4224+***	3320	3600	4000
		330	8.0 × 14.0 × 18.0	B32672L4334+***	2920	3000	2000
		470	9.0 × 17.5 × 18.0	B32672L4474+***	2560	2800	2000
		680	11.0 × 18.5 × 18.0	B32672L4684+***	–	2200	1000
250	630	33	5.0 × 10.5 × 18.0	B32672L6333+***	4680	5200	4000
		47	5.0 × 10.5 × 18.0	B32672L6473+***	4680	5200	4000
		68	6.0 × 11.0 × 18.0	B32672L6683+***	3840	4400	4000
		100	7.0 × 12.5 × 18.0	B32672L6104+***	3320	3600	4000
		150	8.5 × 14.5 × 18.0	B32672L6154+***	2720	2800	2000
		220	9.0 × 17.5 × 18.0	B32672L6224+***	2560	2800	2000
		390	11.0 × 18.5 × 18.0	B32672L6394J***	–	2200	1000
250	1000	10	5.0 × 10.5 × 18.0	B32672L0103+***	4680	5200	4000
		15	5.0 × 10.5 × 18.0	B32672L0153+***	4680	5200	4000
		22	5.0 × 10.5 × 18.0	B32672L0223+***	4680	5200	4000
		33	6.0 × 11.0 × 18.0	B32672L0333+***	3840	4400	4000
		47	7.0 × 12.5 × 18.0	B32672L0473+***	3320	3600	4000
		68	8.5 × 14.5 × 18.0	B32672L0683+***	2720	2800	2000
		100	9.0 × 17.5 × 18.0	B32672L0104+***	2560	2800	2000
		150	11.0 × 18.5 × 18.0	B32672L0154J***	–	2200	1000

MOQ = Minimum Order Quantity, consisting of 4 packing units.

Further E series, intermediate capacitance values and closer tolerances on request.

**Composition of ordering code**

+ = Capacitance tolerance code:

K = ±10%

J = ±5%

\*\*\* = Packaging code:

289 = Ammo pack

189 = Reel

000 = Untaped (lead length 6 – 1 mm)

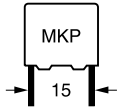
**Ordering codes and packing units (lead spacing 15 mm)**

$V_{RMS}$ $f \leq 1$ kHz V AC	$V_R$ V DC	$C_R$ nF	Max. dimensions $w \times h \times l$ mm	Ordering code (composition see below)	Ammo pack pcs./MOQ	Reel pcs./ MOQ	Untaped pcs./ MOQ
500	1300	6.8	5.0 × 10.5 × 18.0	B32672L7682+***	4680	5200	4000
		10	5.0 × 10.5 × 18.0	B32672L7103+***	4680	5200	4000
		22	7.0 × 12.5 × 18.0	B32672L7223+***	3320	3600	4000
		33	8.5 × 14.5 × 18.0	B32672L7333+***	2720	2800	2000
		47	9.0 × 17.5 × 18.0	B32672L7473+***	2560	2800	2000
		68	11.0 × 18.5 × 18.0	B32672L7683J***	–	2200	1000
600	1600	6.2	5.0 × 10.5 × 18.0	B32672L1622+***	4680	5200	4000
		6.8	5.0 × 10.5 × 18.0	B32672L1682+***	4680	5200	4000
		8.2	6.0 × 11.0 × 18.0	B32672L1822+***	3840	4400	4000
		10	6.0 × 11.0 × 18.0	B32672L1103+***	3840	4400	4000
		12	6.0 × 12.0 × 18.0	B32672L1123+***	3840	4400	4000
		15	7.0 × 12.5 × 18.0	B32672L1153+***	3320	3600	4000
		22	8.5 × 14.5 × 18.0	B32672L1223+***	2720	2800	2000
		33	9.0 × 17.5 × 18.0	B32672L1333+***	2560	2800	2000
		47	11.0 × 18.5 × 18.0	B32672L1473J***	–	2200	1000
		700	2000	1.0	5.0 × 10.5 × 18.0	B32672L8102+***	4680
1.2	5.0 × 10.5 × 18.0			B32672L8122+***	4680	5200	4000
1.5	5.0 × 10.5 × 18.0			B32672L8152+***	4680	5200	4000
2.2	5.0 × 10.5 × 18.0			B32672L8222+***	4680	5200	4000
2.7	5.0 × 10.5 × 18.0			B32672L8272+***	4680	5200	4000
3.3	5.0 × 10.5 × 18.0			B32672L8332+***	4680	5200	4000
3.9	5.0 × 10.5 × 18.0			B32672L8392+***	4680	5200	4000
4.7	5.0 × 10.5 × 18.0			B32672L8472+***	4680	5200	4000
5.6	6.0 × 11.0 × 18.0			B32672L8562+***	3840	4400	4000
6.2	6.0 × 11.0 × 18.0			B32672L8622+***	3840	4400	4000
6.8	6.0 × 11.0 × 18.0			B32672L8682+***	3840	4400	4000
8.2	6.0 × 12.0 × 18.0			B32672L8822+***	3840	4400	4000

MOQ = Minimum Order Quantity, consisting of 4 packing units.

Further E series, intermediate capacitance values and closer tolerances on request.

**Composition of ordering code**

+ = Capacitance tolerance code:

K = ±10%

J = ±5%

\*\*\* = Packaging code:

289 = Ammo pack

189 = Reel

000 = Untaped (lead length 6 – 1 mm)

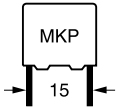
**B32672L**
**High V AC, high temperature (wound)**
**Ordering codes and packing units (lead spacing 15 mm)**

$V_{RMS}$ $f \leq 1$ kHz V AC	$V_R$ V DC	$C_R$ nF	Max. dimensions $w \times h \times l$ mm	Ordering code (composition see below)	Ammo pack pcs./MOQ	Reel pcs./ MOQ	Untaped pcs./ MOQ
700	2000	10	7.0 × 12.5 × 18.0	B32672L8103+***	3320	3600	4000
		12	8.5 × 14.5 × 18.0	B32672L8123+***	2720	2800	2000
		15	8.5 × 14.5 × 18.0	B32672L8153+***	2720	2800	2000
		22	9.0 × 17.5 × 18.0	B32672L8223+***	2560	2800	2000
		33	11.0 × 18.5 × 18.0	B32672L8333J***	–	2200	1000
900	2000	0.68	5.0 × 10.5 × 18.0	B32672L9681+***	4680	5200	4000
		1.0	5.0 × 10.5 × 18.0	B32672L9102+***	4680	5200	4000
		1.2	6.0 × 11.0 × 18.0	B32672L9122J***	3840	4400	4000
		1.5	6.0 × 11.0 × 18.0	B32672L9152+***	3840	4400	4000
		2.2	7.0 × 12.5 × 18.0	B32672L9222+***	3320	3600	4000
		2.7	8.0 × 14.5 × 18.0	B32672L9272J***	2920	3000	2000
		3.3	8.5 × 14.5 × 18.0	B32672L9332+***	2720	2800	2000
		3.9	9.0 × 17.5 × 18.0	B32672L9392J***	2560	2800	2000
		4.7	9.0 × 17.5 × 18.0	B32672L9472+***	2560	2800	2000
		5.6	11.0 × 18.5 × 18.0	B32672L9562+***	–	2200	1000
		6.2	11.0 × 18.5 × 18.0	B32672L9622J***	–	2200	1000
6.8	11.0 × 18.5 × 18.0	B32672L9682K***	–	2200	1000		

MOQ = Minimum Order Quantity, consisting of 4 packing units.

Further E series, intermediate capacitance values and closer tolerances on request.

**Composition of ordering code**

+ = Capacitance tolerance code:

K = ±10%

J = ±5%

\*\*\* = Packaging code:

289 = Ammo pack

189 = Reel

000 = Untaped (lead length 6 – 1 mm)



**Technical data**

Operating temperature range	Max. operating temperature $T_{op,max}$		+125 °C		
	Upper category temperature $T_{max}$		+110 °C		
	Lower category temperature $T_{min}$		-55 °C		
	Rated temperature $T_R$		+85 °C		
Dissipation factor $\tan \delta$ (in $10^{-3}$ ) at 20 °C (upper limit values)	at	$\leq 27$ nF	$27$ nF $< C_R \leq 0.1$ $\mu$ F	$0.1$ $\mu$ F $< C_R \leq 1$ $\mu$ F	$> 1$ $\mu$ F
	1 kHz	0.8	0.8	0.8	0.8
	10 kHz	1.0	1.0	1.0	—
	100 kHz	2.0	3.0	—	—
Insulation resistance $R_{ins}$ at 20 °C, rel. humidity $\leq 65\%$ (minimum as-delivered values)	$> 100$ G $\Omega$ ( $C_R \leq 0.33$ $\mu$ F) $< 30000$ s ( $C_R > 0.33$ $\mu$ F)				
DC test voltage	$1.6 \cdot V_R$ , 2 s				
Category voltage $V_C$ (continuous operation with $V_{DC}$ or $V_{AC}$ at $f \leq 1$ kHz)	$T_A$ (°C)	DC voltage derating		AC voltage derating	
	$T_A \leq 85$ $85 < T_A \leq 110$	$V_C = V_R$ $V_C = V_R \cdot (165 - T_A)/80$		$V_{C,RMS} = V_{RMS}$ $V_{C,RMS} = V_{RMS} \cdot (165 - T_A)/80$	
Operating voltage $V_{op}$ for short operating periods ( $V_{DC}$ or $V_{AC}$ at $f \leq 1$ kHz)	$T_A$ (°C)	DC voltage (max. hours)		AC voltage (max. hours)	
	$T_A \leq 100$ $100 < T_A \leq 125$	$V_{op} = 1.25 \cdot V_C$ (2000 h) $V_{op} = 1.25 \cdot V_C$ (1000 h)		$V_{op} = 1.0 \cdot V_{C,RMS}$ (2000 h) $V_{op} = 1.0 \cdot V_{C,RMS}$ (1000 h)	
Damp heat test	56 days/40 °C/93% relative humidity				
Limit values after damp heat test	Capacitance change $ \Delta C/C $		$\leq 2\%$		
	Dissipation factor change $\Delta \tan \delta$		$\leq 1.0 \cdot 10^{-3}$ (at 1 kHz)		
	Insulation resistance $R_{ins}$		$\geq 50$ G $\Omega$		
Reliability:					
Failure rate $\lambda$	1 fit ( $\leq 1 \cdot 10^{-9}$ /h) at $0.5 \cdot V_R$ , 40 °C				
Service life $t_{SL}$	200 000 h at $1.0 \cdot V_R$ , 85 °C				
	For conversion to other operating conditions and temperatures, refer to chapter "Quality, 2 Reliability".				
Failure criteria:					
Total failure	Short circuit or open circuit				
Failure due to variation of parameters	Capacitance change $ \Delta C/C $		$> 10\%$		
	Dissipation factor $\tan \delta$		$> 4 \cdot$ upper limit values		
	Insulation resistance $R_{ins}$		$< 1500$ M $\Omega$		

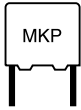
**B32671L ... B32672L**
**High V AC, high temperature (wound)**

### Pulse handling capability

"dV/dt" represents the maximum permissible voltage change per unit of time for non-sinusoidal voltages, expressed in V/ $\mu$ s.

"k<sub>0</sub>" represents the maximum permissible pulse characteristic of the waveform applied to the capacitor, expressed in V<sup>2</sup>/ $\mu$ s.

*Note:*

*The values of dV/dt and k<sub>0</sub> provided below must not be exceeded in order to avoid damaging the capacitor.*

### dV/dt values

Lead spacing	10 mm					
Type	B32671L					
V <sub>RMS</sub> (V AC)	200	250		500	600	700
V <sub>R</sub> (V DC)	400	630	1000	1000	1600	2000
C <sub>R</sub> (nF)	dV/dt in V/ $\mu$ s					
1.0	–	–	–	–	–	11000
1.2	–	–	–	–	6000	10000
1.5	–	–	–	–	5600	9500
2.2	–	–	–	–	5200	9000
2.7	–	–	–	–	5000	8600
3.3	–	–	–	4700	4700	8500
3.9	–	–	–	4300	4500	8200
4.7	–	–	810	3800	4000	8000
5.6	–	–	–	3400	–	–
6.2	–	–	–	3200	–	–
6.8	–	–	810	3100	–	–
8.2	–	–	–	2700	–	–
10	–	–	810	2500	–	–
12	–	–	–	2300	–	–
15	–	540	810	–	–	–
22	400	540	810	–	–	–
33	400	540	–	–	–	–
47	400	540	–	–	–	–
56	–	540	–	–	–	–
68	400	–	–	–	–	–
100	400	–	–	–	–	–

**dV/dt values**

Lead spacing	15 mm							
Type	B32672L							
V <sub>RMS</sub> (V AC)	160	200	250		500	600	700	900
V <sub>R</sub> (V DC)	250	420	630	1000	1300	1600	2000	2000
C <sub>R</sub> (nF)	dV/dt in V/μs							
0.68	–	–	–	–	–	–	–	15000
1.0	–	–	–	–	–	–	10000	15000
1.2	–	–	–	–	–	–	9400	14100
1.5	–	–	–	–	–	–	9000	13500
2.2	–	–	–	–	–	–	7500	11000
2.7	–	–	–	–	–	–	7100	10600
3.3	–	–	–	–	–	–	6800	10000
3.9	–	–	–	–	–	–	6000	9000
4.7	–	–	–	–	–	–	5500	8200
5.6	–	–	–	–	–	–	5000	7500
6.2	–	–	–	–	–	3600	4700	7000
6.8	–	–	–	–	1000	3500	4500	6700
8.2	–	–	–	–	–	3100	4200	–
10	–	–	–	445	1000	2800	3900	–
12	–	–	–	–	–	2600	3600	–
15	–	–	–	445	–	2300	3300	–
22	–	–	–	445	1000	2000	2900	–
33	–	–	300	445	1000	1700	2300	–
47	–	–	300	445	1000	1400	–	–
56	–	–	–	–	–	–	–	–
68	–	200	300	445	1000	–	–	–
100	–	200	300	445	–	–	–	–
150	170	200	300	445	–	–	–	–
220	170	200	300	–	–	–	–	–
330	170	200	–	–	–	–	–	–
390	–	–	300	–	–	–	–	–
470	170	200	–	–	–	–	–	–
680	170	200	–	–	–	–	–	–
1000	170	–	–	–	–	–	–	–

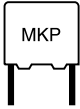
**B32671L ... B32672L**
**High V AC, high temperature (wound)**
 **$k_0$  values**

Lead spacing	10 mm					
Type	B32671L					
$V_{RMS}$ (V AC)	200	250		500	600	700
$V_R$ (V DC)	400	630	1000	1000	1600	2000
$C_R$ (nF)	$k_0$ in $V^2/\mu s$					
1.0	–	–	–	–	–	25000000
1.2	–	–	–	–	14400000	23000000
1.5	–	–	–	–	14000000	22500000
2.2	–	–	–	–	13800000	22000000
2.7	–	–	–	–	13600000	21500000
3.3	–	–	–	9400000	13300000	21000000
3.9	–	–	–	8600000	13100000	20900000
4.7	–	–	400000	8200000	12000000	20800000
5.6	–	–	–	7600000	–	–
6.2	–	–	–	6800000	–	–
6.8	–	–	400000	6200000	–	–
8.2	–	–	–	5400000	–	–
10	–	–	400000	5000000	–	–
12	–	–	–	4600000	–	–
15	–	200000	400000	–	–	–
22	150000	200000	400000	–	–	–
33	150000	200000	–	–	–	–
47	150000	200000	–	–	–	–
56	–	200000	–	–	–	–
68	150000	–	–	–	–	–
100	150000	–	–	–	–	–

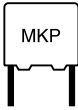
 **$k_0$  values**

Lead spacing	15 mm							
Type	B32672L							
$V_{RMS}$ (V AC)	160	200	250		500	600	700	900
$V_R$ (V DC)	250	420	630	1000	1300	1600	2000	2000
$C_R$ (nF)	$k_0$ in $V^2/\mu s$							
0.68	–	–	–	–	–	–	–	3000000
1.0	–	–	–	–	–	–	20300000	3000000
1.2	–	–	–	–	–	–	19600000	29400000
1.5	–	–	–	–	–	–	19200000	28000000
2.2	–	–	–	–	–	–	18600000	27500000
2.7	–	–	–	–	–	–	18200000	27300000
3.3	–	–	–	–	–	–	18000000	27000000
3.9	–	–	–	–	–	–	16800000	25200000
4.7	–	–	–	–	–	–	15800000	23500000
5.6	–	–	–	–	–	–	13100000	19500000
6.2	–	–	–	–	–	11520000	12700000	19000000
6.8	–	–	–	–	3000000	11200000	12300000	18400000
8.2	–	–	–	–	–	9920000	11800000	–
10	–	–	–	1000000	3000000	8960000	11100000	–
12	–	–	–	–	–	8320000	10600000	–
15	–	–	–	1000000	–	7360000	10400000	–
22	–	–	–	1000000	3000000	6400000	9300000	–
33	–	–	500000	1000000	3000000	5440000	9000000	–
47	–	–	500000	1000000	3000000	4480000	–	–
56	–	–	–	–	–	–	–	–
68	–	120000	500000	1000000	3000000	–	–	–
100	–	120000	500000	1000000	–	–	–	–
150	100000	120000	500000	1000000	–	–	–	–
220	100000	120000	500000	–	–	–	–	–
330	100000	120000	–	–	–	–	–	–
390	–	–	500000	–	–	–	–	–
470	100000	120000	–	–	–	–	–	–
680	100000	–	–	–	–	–	–	–
1000	100000	–	–	–	–	–	–	–

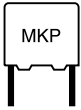

B32671L ... B32672L

High V AC, high temperature (wound)

### Impedance Z versus frequency f

(typical values)

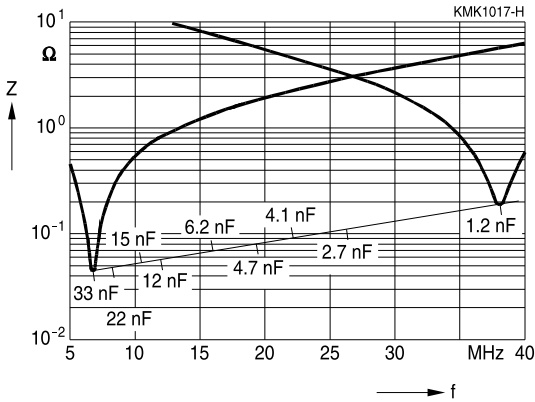

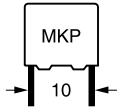

**Permissible AC voltage  $V_{RMS}$  versus frequency  $f$  (for sinusoidal waveforms  $T_A \leq 100^\circ\text{C}$ )**  
 For  $T_A > 100^\circ\text{C}$ , please refer to "General technical information", section 3.2.3.

**Lead spacing 10 mm**

400 V DC/200 V AC

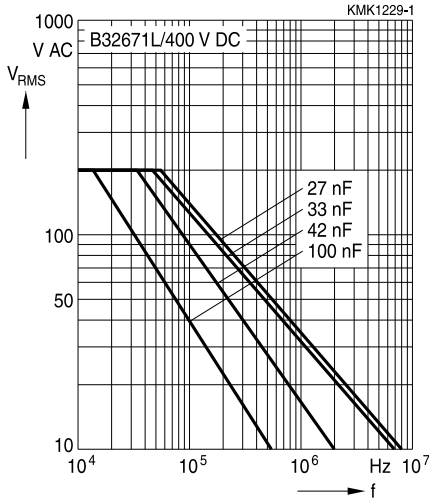

630 V DC/250 V AC

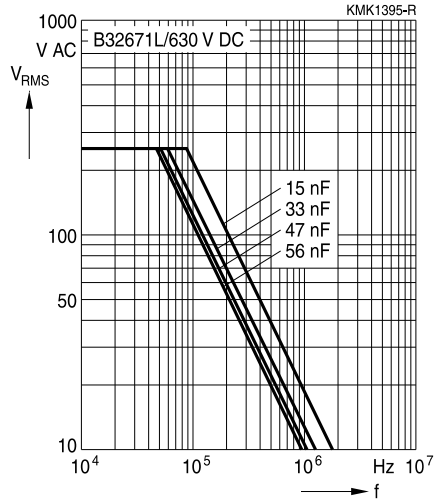

1000 V DC/250 V AC

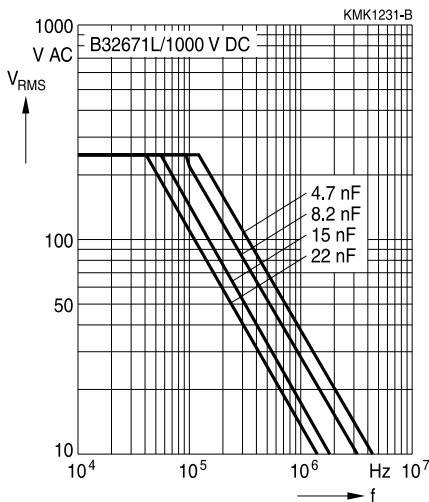

1000 V DC/500 V AC

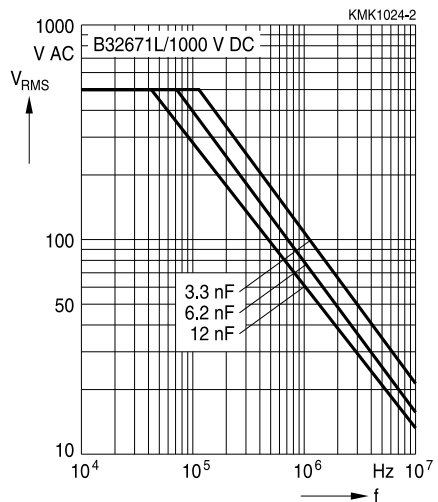

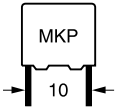

**B32671L**

**High V AC, high temperature (wound)**

**Permissible AC voltage  $V_{RMS}$  versus frequency  $f$  (for sinusoidal waveforms  $T_A \leq 100\text{ }^\circ\text{C}$ )**  
 For  $T_A > 100\text{ }^\circ\text{C}$ , please refer to "General technical information", section 3.2.3.

**Lead spacing 10 mm**

**1600 V DC/600 V AC**

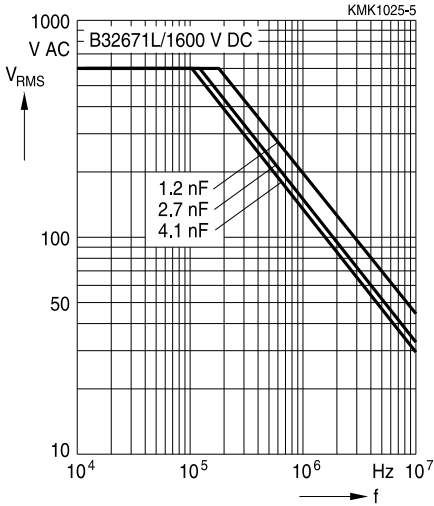

**2000 V DC/700 V AC**

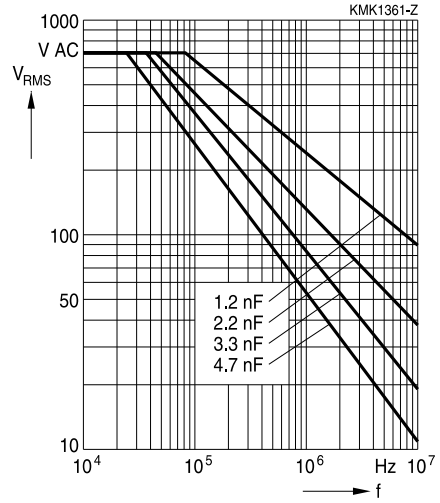



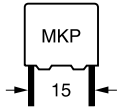

**Permissible AC voltage  $V_{RMS}$  versus frequency  $f$  (for sinusoidal waveforms  $T_A \leq 100^\circ\text{C}$ )**  
 For  $T_A > 100^\circ\text{C}$ , please refer to "General technical information", section 3.2.3.

**Lead spacing 15 mm**

**250 V DC/160 V AC**

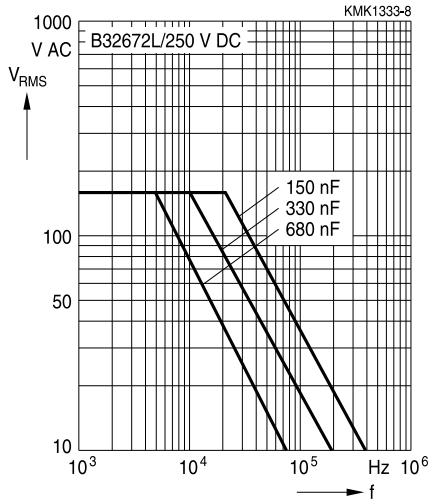

**420 V DC/200 V AC**

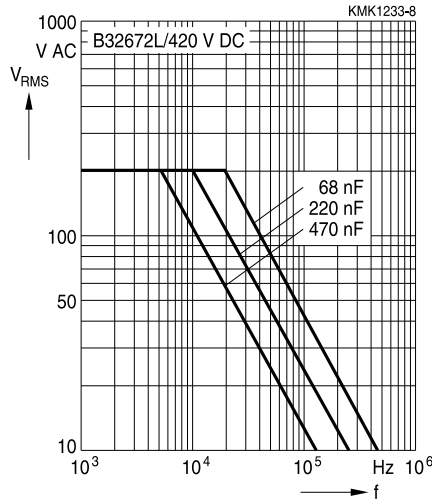

**630 V DC/250 V AC**

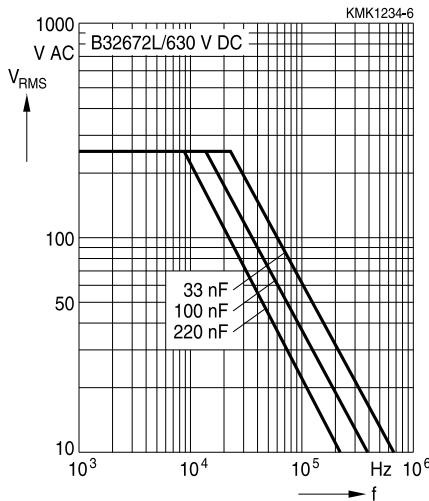

**1000 V DC/250 V AC**

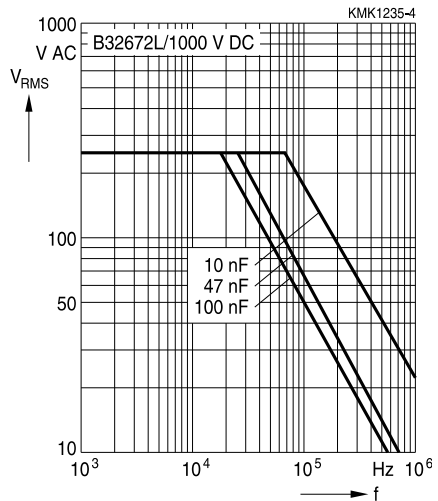

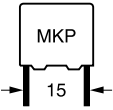

**B32672L**

**High V AC, high temperature (wound)**

**Permissible AC voltage  $V_{RMS}$  versus frequency  $f$  (for sinusoidal waveforms  $T_A \leq 100^\circ C$ )**  
 For  $T_A > 100^\circ C$ , please refer to "General technical information", section 3.2.3.

**Lead spacing 15 mm**

**1300 V DC/500 V AC**

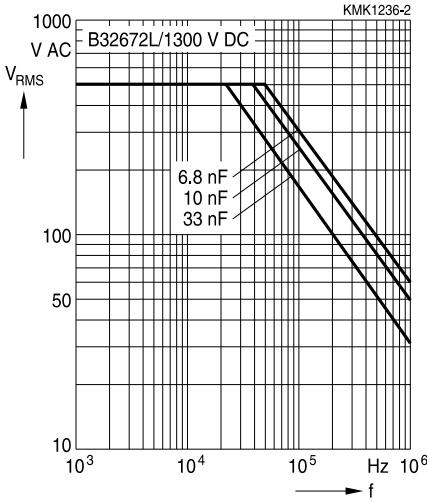

**1600 V DC/600 V AC**

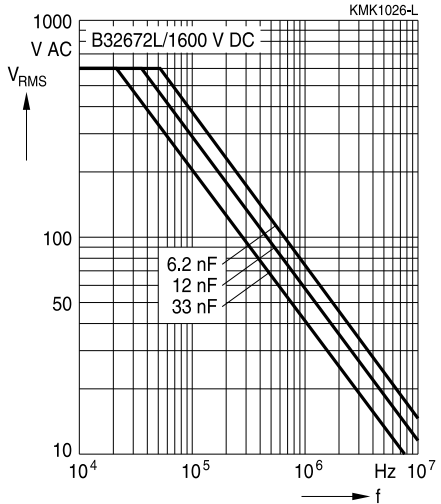

**2000 V DC/700 V AC**

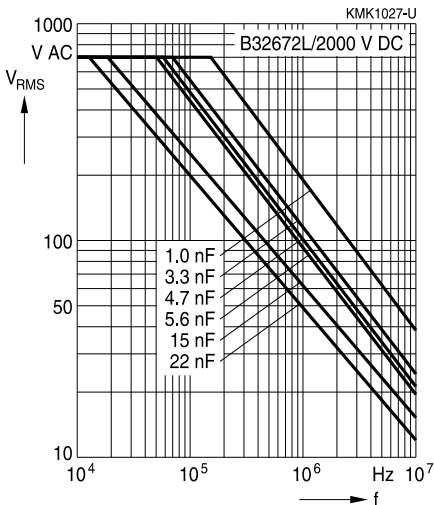

**2000 V DC/900 V AC**

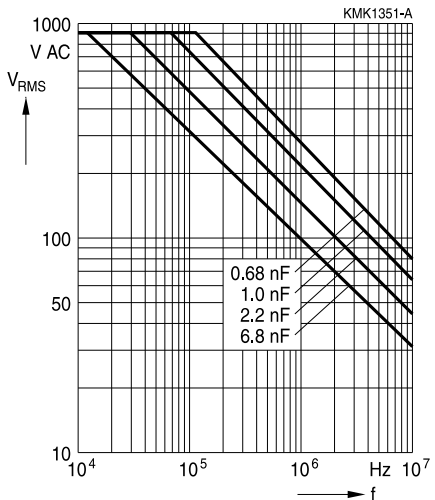

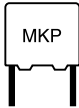

**Operation at overvoltages during heating and ignition of lamps ( $T_A \leq 40^\circ C$ )**

In lighting applications, the capacitors can be subjected to overvoltages during the heating and ignition periods. An overvoltage occurs when the operation voltage exceeds the permissible AC voltage at the resonant frequency  $f_r$ .

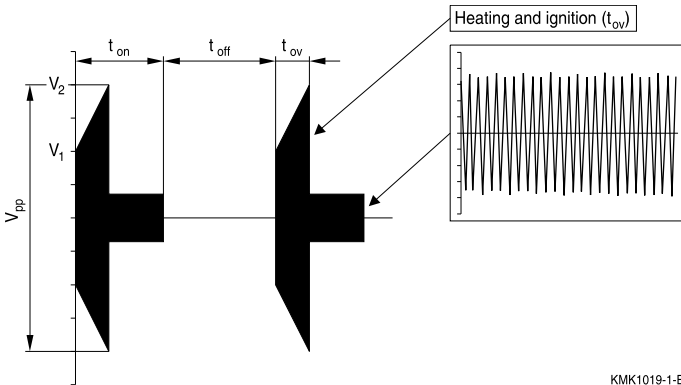

KMK1019-1-E

For a repetitive application of on/off switching pulses (as for example in the life tests applied by electronic ballast manufacturers), limits have to be imposed on the time periods under overvoltage and on the duty cycle, in order to keep the capacitance value within the required margins:

- The overvoltage time  $t_{OV}$  should be less than 1 sec.
- The maximum duty cycle of the overvoltage is given by

$$\frac{t_{OV}}{t_{on} + t_{off}} \leq \left( \frac{V_{RMS}}{V_{RMS.OV}} \right)^2 \cdot 0.5$$

where  $V_{RMS.OV}$  is the RMS voltage during period  $t_{OV}$

$$V_{rms.OV} = \sqrt{\frac{V_1^2 + V_1 \cdot V_2 + V_2^2}{6}}$$

and  $V_{RMS}$  is the permissible AC voltage for continuous operation at the resonant frequency  $f_r$  (given by the "permissible AC voltage versus frequency  $f$ " graphics in the previous pages).

- The drift of capacitance depends on the  $V_{pp}$  attained, and the total time under overvoltage, which is calculated in hours as follows:  
 $(N_i \cdot t_{OV}) / 3600$   
 where  $N_i$  is the number of overvoltage impulses and  $t_{OV}$  is expressed in seconds.

The maximum drift of capacitance as a function of both parameters is provided graphically in the following pages.

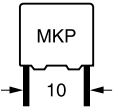

**B32671L**

**High V AC, high temperature (wound)**

**Estimation of the maximum drift of capacitance value in function of the number of total hours overvoltage**

**Lead spacing 10 mm**

500 V AC/1000 V DC

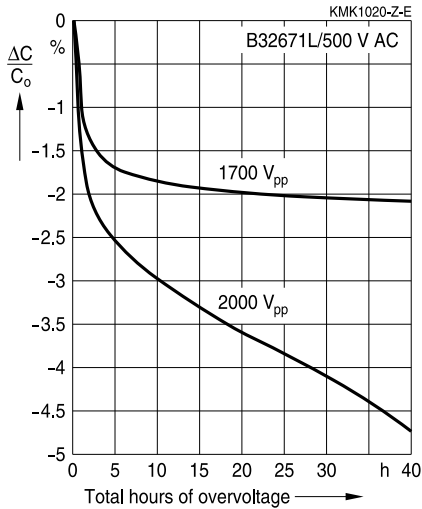

600 V AC/1600 V DC

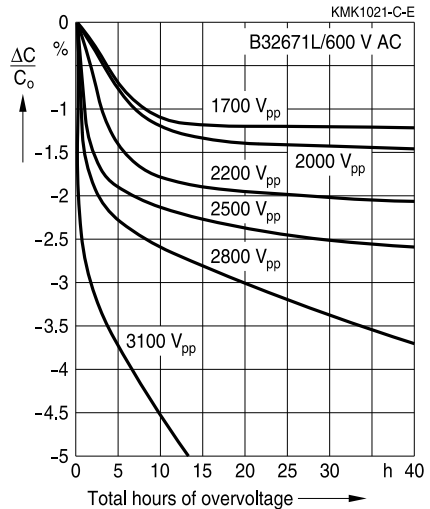

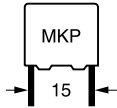

**Estimation of the maximum drift of capacitance value in function of the number of total hours overvoltage**

**Lead spacing 15 mm**

600 V AC/1600 V DC

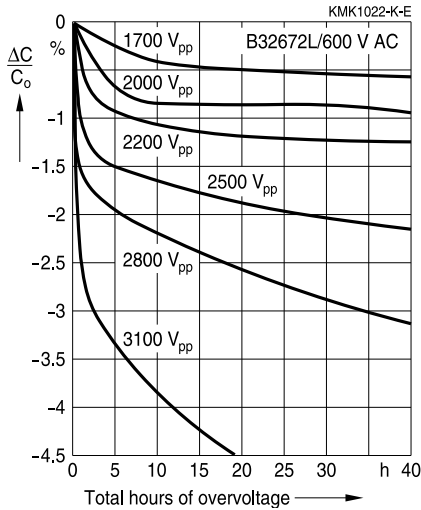

700 V AC/2000 V DC

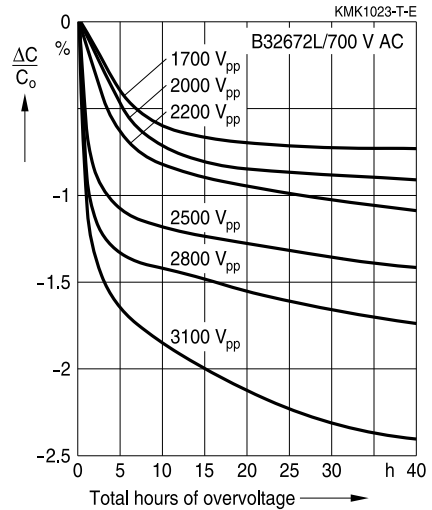

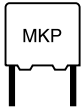
**B32671L ... B32672L**
**High V AC, high temperature (wound)**

## Mounting guidelines

### 1 Soldering

#### 1.1 Solderability of leads

The solderability of terminal leads is tested to IEC 60068-2-20, test Ta, method 1.

Before a solderability test is carried out, terminals are subjected to accelerated ageing (to IEC 60068-2-2, test Ba: 4 h exposure to dry heat at 155 °C). Since the ageing temperature is far higher than the upper category temperature of the capacitors, the terminal wires should be cut off from the capacitor before the ageing procedure to prevent the solderability being impaired by the products of any capacitor decomposition that might occur.

Solder bath temperature	235 ±5 °C
Soldering time	2.0 ±0.5 s
Immersion depth	2.0 +0/-0.5 mm from capacitor body or seating plane
Evaluation criteria:	
Visual inspection	Wetting of wire surface by new solder ≥90%, free-flowing solder

#### 1.2 Resistance to soldering heat

Resistance to soldering heat is tested to IEC 60068-2-20, test Tb, method 1A.

Conditions:

Series	Solder bath temperature	Soldering time
MKT boxed (except 2.5 × 6.5 × 7.2 mm) coated uncoated (lead spacing > 10 mm)	260 ±5 °C	10 ±1 s
MFP MKP (lead spacing > 7.5 mm)		
MKT boxed (case 2.5 × 6.5 × 7.2 mm)		5 ±1 s
MKP (lead spacing ≤ 7.5 mm)		< 4 s
MKT uncoated (lead spacing ≤ 10 mm) insulated (B32559)		recommended soldering profile for MKT uncoated (lead spacing ≤ 10 mm) and insulated (B32559)

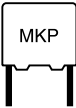

High V AC, high temperature (wound)

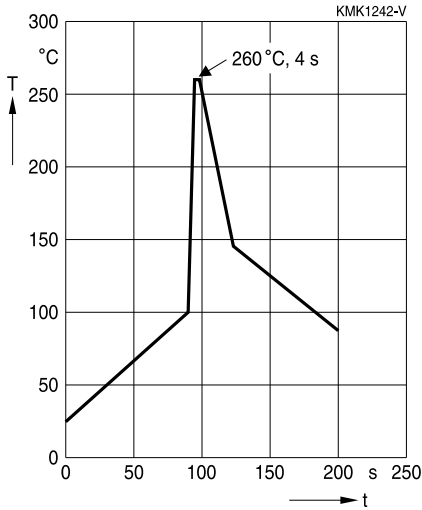

Immersion depth	2.0 +0/−0.5 mm from capacitor body or seating plane
Shield	Heat-absorbing board, (1.5 ±0.5) mm thick, between capacitor body and liquid solder
Evaluation criteria:	
Visual inspection	No visible damage
$\Delta C/C_0$	2% for MKT/MKP/MFP 5% for EMI suppression capacitors
$\tan \delta$	As specified in sectional specification



B32671L ... B32672L

High V AC, high temperature (wound)

### 1.3 General notes on soldering

Permissible heat exposure loads on film capacitors are primarily characterized by the upper category temperature  $T_{max}$ . Long exposure to temperatures above this type-related temperature limit can lead to changes in the plastic dielectric and thus change irreversibly a capacitor's electrical characteristics. For short exposures (as in practical soldering processes) the heat load (and thus the possible effects on a capacitor) will also depend on other factors like:

- Pre-heating temperature and time
- Forced cooling immediately after soldering
- Terminal characteristics:
  - diameter, length, thermal resistance, special configurations (e.g. crimping)
- Height of capacitor above solder bath
- Shadowing by neighboring components
- Additional heating due to heat dissipation by neighboring components
- Use of solder-resist coatings

The overheating associated with some of these factors can usually be reduced by suitable countermeasures. For example, if a pre-heating step cannot be avoided, an additional or reinforced cooling process may possibly have to be included.

EPCOS recommends the following conditions:

- Pre-heating with a maximum temperature of 110 °C
- Temperature inside the capacitor should not exceed the following limits:
  - MKP/MFP 110 °C
  - MKT 160 °C
- When SMD components are used together with leaded ones, the leaded film capacitors should not pass into the SMD adhesive curing oven. The leaded components should be assembled after the SMD curing step.
- Leaded film capacitors are not suitable for reflow soldering.

#### Uncoated capacitors

For uncoated MKT capacitors with lead spacings  $\leq 10$  mm (B32560/B32561) the following measures are recommended:

- pre-heating to not more than 110 °C in the preheater phase
- rapid cooling after soldering



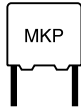

### Cautions and warnings

- Do not exceed the upper category temperature (UCT).
- Do not apply any mechanical stress to the capacitor terminals.
- Avoid any compressive, tensile or flexural stress.
- Do not move the capacitor after it has been soldered to the PC board.
- Do not pick up the PC board by the soldered capacitor.
- Do not place the capacitor on a PC board whose PTH hole spacing differs from the specified lead spacing.
- Do not exceed the specified time or temperature limits during soldering.
- Avoid external energy inputs, such as fire or electricity.
- Avoid overload of the capacitors.

The table below summarizes the safety instructions that must always be observed. A detailed description can be found in the relevant sections of the chapters "General technical information" and "Mounting guidelines".

Topic	Safety information	Reference chapter "General technical information"
Storage conditions	Make sure that capacitors are stored within the specified range of time, temperature and humidity conditions.	4.5 "Storage conditions"
Flammability	Avoid external energy, such as fire or electricity (passive flammability), avoid overload of the capacitors (active flammability) and consider the flammability of materials.	5.3 "Flammability"
Resistance to vibration	Do not exceed the tested ability to withstand vibration. The capacitors are tested to IEC 60068-2-6. EPCOS offers film capacitors specially designed for operation under more severe vibration regimes such as those found in automotive applications. Consult our catalog "Film Capacitors for Automotive Electronics".	5.2 "Resistance to vibration"

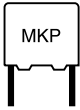

B32671L ... B32672L

High V AC, high temperature (wound)

Topic	Safety information	Reference chapter "Mounting guidelines"
Soldering	Do not exceed the specified time or temperature limits during soldering.	1 "Soldering"
Cleaning	Use only suitable solvents for cleaning capacitors.	2 "Cleaning"
Embedding of capacitors in finished assemblies	When embedding finished circuit assemblies in plastic resins, chemical and thermal influences must be taken into account. Caution: Consult us first, if you also wish to embed other uncoated component types!	3 "Embedding of capacitors in finished assemblies"

**Symbols and terms**

Symbol	English	German
$\alpha$	Heat transfer coefficient	Wärmeübergangszahl
$\alpha_C$	Temperature coefficient of capacitance	Temperaturkoeffizient der Kapazität
A	Capacitor surface area	Kondensatoroberfläche
$\beta_C$	Humidity coefficient of capacitance	Feuchtekoeffizient der Kapazität
C	Capacitance	Kapazität
$C_R$	Rated capacitance	Nennkapazität
$\Delta C$	Absolute capacitance change	Absolute Kapazitätsänderung
$\Delta C/C$	Relative capacitance change (relative deviation of actual value)	Relative Kapazitätsänderung (relative Abweichung vom Ist-Wert)
$\Delta C/C_R$	Capacitance tolerance (relative deviation from rated capacitance)	Kapazitätstoleranz (relative Abweichung vom Nennwert)
dt	Time differential	Differentielle Zeit
$\Delta t$	Time interval	Zeitintervall
$\Delta T$	Absolute temperature change (self-heating)	Absolute Temperaturänderung (Selbsterwärmung)
$\Delta \tan \delta$	Absolute change of dissipation factor	Absolute Änderung des Verlustfaktors
$\Delta V$	Absolute voltage change	Absolute Spannungsänderung
dV/dt	Time differential of voltage function (rate of voltage rise)	Differentielle Spannungsänderung (Spannungsflankensteilheit)
$\Delta V/\Delta t$	Voltage change per time interval	Spannungsänderung pro Zeitintervall
E	Activation energy for diffusion	Aktivierungsenergie zur Diffusion
ESL	Self-inductance	Eigeninduktivität
ESR	Equivalent series resistance	Ersatz-Serienwiderstand
f	Frequency	Frequenz
$f_1$	Frequency limit for reducing permissible AC voltage due to thermal limits	Grenzfrequenz für thermisch bedingte Reduzierung der zulässigen Wechselspannung
$f_2$	Frequency limit for reducing permissible AC voltage due to current limit	Grenzfrequenz für strombedingte Reduzierung der zulässigen Wechselspannung
$f_r$	Resonant frequency	Resonanzfrequenz
$F_D$	Thermal acceleration factor for diffusion	Therm. Beschleunigungsfaktor zur Diffusion
$F_T$	Derating factor	Deratingfaktor
i	Current (peak)	Stromspitze
$I_C$	Category current (max. continuous current)	Kategoriestrom (max. Dauerstrom)

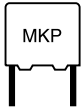

**B32671L ... B32672L**

**High V AC, high temperature (wound)**

Symbol	English	German
$I_{RMS}$	(Sinusoidal) alternating current, root-mean-square value	(Sinusförmiger) Wechselstrom
$i_z$	Capacitance drift	Inkonstanz der Kapazität
$k_0$	Pulse characteristic	Impuls Kennwert
$L_S$	Series inductance	Serieninduktivität
$\lambda$	Failure rate	Ausfallrate
$\lambda_0$	Constant failure rate during useful service life	Konstante Ausfallrate in der Nutzungsphase
$\lambda_{test}$	Failure rate, determined by tests	Experimentell ermittelte Ausfallrate
$P_{diss}$	Dissipated power	Abgegebene Verlustleistung
$P_{gen}$	Generated power	Erzeugte Verlustleistung
$Q$	Heat energy	Wärmeenergie
$\rho$	Density of water vapor in air	Dichte von Wasserdampf in Luft
$R$	Universal molar constant for gases	Allg. Molarkonstante für Gas
$R$	Ohmic resistance of discharge circuit	Ohmscher Widerstand des Entladekreises
$R_i$	Internal resistance	Innenwiderstand
$R_{ins}$	Insulation resistance	Isolationswiderstand
$R_P$	Parallel resistance	Parallelwiderstand
$R_S$	Series resistance	Serienwiderstand
$S$	severity (humidity test)	Schärfegrad (Feuchtest)
$t$	Time	Zeit
$T$	Temperature	Temperatur
$\tau$	Time constant	Zeitkonstante
$\tan \delta$	Dissipation factor	Verlustfaktor
$\tan \delta_D$	Dielectric component of dissipation factor	Dielektrischer Anteil des Verlustfaktors
$\tan \delta_P$	Parallel component of dissipation factor	Parallelanteil des Verlustfaktors
$\tan \delta_S$	Series component of dissipation factor	Serienanteil des Verlustfaktors
$T_A$	Ambient temperature	Umgebungstemperatur
$T_{max}$	Upper category temperature	Obere Kategorietemperatur
$T_{min}$	Lower category temperature	Untere Kategorietemperatur
$t_{OL}$	Operating life at operating temperature and voltage	Betriebszeit bei Betriebstemperatur und -spannung
$T_{op}$	Operating temperature	Betriebstemperatur
$T_R$	Rated temperature	Nenntemperatur
$T_{ref}$	Reference temperature	Referenztemperatur
$t_{SL}$	Reference service life	Referenz-Lebensdauer
$V_{AC}$	AC voltage	Wechselspannung

Symbol	English	German
$V_C$	Category voltage	Kategorie <span>spannung</span>
$V_{C,RMS}$	Category AC voltage	(Sinusförmige) Kategorie-Wechsel <span>spannung</span>
$V_{CD}$	Corona-discharge onset voltage	Teilentlade-Einsatz <span>spannung</span>
$V_{ch}$	Charging voltage	Ladespannung
$V_{DC}$	DC voltage	Gleichspannung
$V_{FB}$	Fly-back capacitor voltage	Spannung (Flyback)
$V_i$	Input voltage	Eingangsspannung
$V_o$	Output voltage	Ausgangssspannung
$V_{op}$	Operating voltage	Betriebsspannung
$V_p$	Peak pulse voltage	Impuls-Spitzen <span>spannung</span>
$V_{pp}$	Peak-to-peak voltage Impedance	Spannungshub
$V_R$	Rated voltage	Nennspannung
$\hat{V}_R$	Amplitude of rated AC voltage	Amplitude der Nenn-Wechsel <span>spannung</span>
$V_{RMS}$	(Sinusoidal) alternating voltage, root-mean-square value	(Sinusförmige) Wechsel <span>spannung</span>
$V_{SC}$	S-correction voltage	Spannung bei Anwendung "S-correction"
$V_{sn}$	Snubber capacitor voltage	Spannung bei Anwendung "Beschaltung"
$Z$	Impedance	Scheinwiderstand
$e$	Lead spacing	Rastermaß

## Important notes

The following applies to all products named in this publication:

1. Some parts of this publication contain **statements about the suitability of our products for certain areas of application**. These statements are based on our knowledge of typical requirements that are often placed on our products in the areas of application concerned. We nevertheless expressly point out **that such statements cannot be regarded as binding statements about the suitability of our products for a particular customer application**. As a rule, EPCOS is either unfamiliar with individual customer applications or less familiar with them than the customers themselves. For these reasons, it is always ultimately incumbent on the customer to check and decide whether an EPCOS product with the properties described in the product specification is suitable for use in a particular customer application.
2. We also point out that **in individual cases, a malfunction of electronic components or failure before the end of their usual service life cannot be completely ruled out in the current state of the art, even if they are operated as specified**. In customer applications requiring a very high level of operational safety and especially in customer applications in which the malfunction or failure of an electronic component could endanger human life or health (e.g. in accident prevention or lifesaving systems), it must therefore be ensured by means of suitable design of the customer application or other action taken by the customer (e.g. installation of protective circuitry or redundancy) that no injury or damage is sustained by third parties in the event of malfunction or failure of an electronic component.
3. **The warnings, cautions and product-specific notes must be observed.**
4. In order to satisfy certain technical requirements, **some of the products described in this publication may contain substances subject to restrictions in certain jurisdictions (e.g. because they are classed as hazardous)**. Useful information on this will be found in our Material Data Sheets on the Internet ([www.epcos.com/material](http://www.epcos.com/material)). Should you have any more detailed questions, please contact our sales offices.
5. We constantly strive to improve our products. Consequently, **the products described in this publication may change from time to time**. The same is true of the corresponding product specifications. Please check therefore to what extent product descriptions and specifications contained in this publication are still applicable before or when you place an order. We also **reserve the right to discontinue production and delivery of products**. Consequently, we cannot guarantee that all products named in this publication will always be available. The aforementioned does not apply in the case of individual agreements deviating from the foregoing for customer-specific products.
6. Unless otherwise agreed in individual contracts, **all orders are subject to the current version of the "General Terms of Delivery for Products and Services in the Electrical Industry" published by the German Electrical and Electronics Industry Association (ZVEI)**.
7. The trade names EPCOS, BAOKE, Alu-X, CeraDiode, CeraLink, CSMP, CSSP, CTVS, DeltaCap, DigiSiMic, DSSP, FilterCap, FormFit, MiniBlue, MiniCell, MKD, MKK, MLSC, MotorCap, PCC, PhaseCap, PhaseCube, PhaseMod, PhiCap, SIFERRIT, SIFI, SIKOREL, SilverCap, SIMDAD, SiMic, SIMID, SineFormer, SIOV, SIP5D, SIP5K, ThermoFuse, WindCap are **trademarks registered or pending** in Europe and in other countries. Further information will be found on the Internet at [www.epcos.com/trademarks](http://www.epcos.com/trademarks).