

RoHS  
Ready 



# SOLARLOK Interconnection System

**OBSOLETE**  
NOT the LATEST  
REVISION



---

 Table of Contents
 

---

The SOLARLOK Concept .....	1
Large Junction Box – Serial Interconnection .....	2
Large Junction Box – Parallel Interconnection .....	3
Medium Junction Box – Serial Interconnection .....	4
Small Junction Box – Serial Interconnection .....	6
Mini Junction Box – Serial Interconnection .....	8
Cable Coupler .....	9
T-Branch Connector .....	10
DC/AC Converter Receptacle .....	11
AC Inverter Connector .....	12
Solar Cable .....	13
Solar Cable, 1-Pole .....	14
Field Wiring, Switching and Protection .....	15
Wiring Example with Extension Cable .....	16
SolKlip™ – Ground Clip .....	18
Interconnection Examples .....	20
Application Tooling .....	22
Assembly and Installation Guidelines .....	24
Technical Data .....	29
Numerical Index .....	30
Restriction on the Use of Hazardous Substances (RoHS) .....	31
Engineering Notes .....	32

---

**Product Information Center (PIC)**

---

Our PIC team are there to help with any further questions.

With our experienced employees in the Product Information Center (PIC) we can offer you a reliable source of information and support for your technical queries.

**To contact your local Tyco Electronics subsidiary, please refer to the address page at the back of this catalog.**

---

**Product und Machine Literature**

---

Order quickly and easily by fax:

**For Fax No. see address page entry for your specific region.**

A large product range has extensive product literature. You can request flyers, catalogs and brochures for each of the product sectors of relevance to you.

---

**Tyco Electronics Online**

---

Internet Homepage:  
**[www.tycoelectronics.com](http://www.tycoelectronics.com)**

Electronic Internet Catalog:  
**<http://catalog.tycoelectronics.com>**



Our website is more than an Internet guide. It is constantly being added to and is an innovative and interactive source for applications tips, product updates and technical information of all types. With our innovative StepSearch software, which has been perfected over a period of several years you can conveniently surf your way through all our products.



## The SOLARLOK Concept

### System Features

#### Junction Box

- Variable wiring options
- Easily accessible
- Simple, fast and cost-effective assembly
- Flat, low profile design
- High current carrying capacity
- Good thermal balance
- Connectorized or direct wire configurations
- Up to four outputs possible
- Up to six internal rails
- Customer-specific solutions
- TÜV and UL approved

#### Connector

- Simple on-site processing
- Mating safety provided by keyed housings
- Semi-automatic assembly capability possible
- Multiple plugging and unplugging cycles
- Accommodates solar cable with different insulation diameters
- High current carrying capacity
- Wide temperature operating range
- TÜV and UL approved

#### Solar Cable

- Dual wall insulation
- Electron beam cross-linked
- Excellent resistance to U.V., water, ozone, fluids, salt, general weathering
- Excellent resistance to abrasion
- Halogen free, flame retardant, low toxicity
- Very low smoke emissions
- Excellent flexibility and stripping performance
- Different cable diameters
- Operating Temperature from -40 °C up to +120 °C
- Voltage Rating up to 2600 V DC
- IEC 60228 Class 5 (stranded tin plated copper and flexible)
- TÜV certified acc. to 2Pfg 1169/08.2007
- UL certified



### Simple and Reliable System Interconnection of Individual Solar Modules Right to the DC/AC Converters

Market expansion of the formerly regulated energy supply sector, increased global environmental awareness and governments committing themselves to more stringent environmental targets have opened up new opportunities for the photovoltaic industry.

Having served a niche market in the past, the photovoltaics industry now has the opportunity to move into mass production, realizing economies of scale and gaining a greater market share of the world's energy mix.

Tyco Electronics will be contributing to the establishment of this environmentally-friendly technology with the introduction of its SOLARLOK connector system.

SOLARLOK delivers a flexible system solution for easy and reliable interconnections from photovoltaic modules to the DC/AC converter. The entire system concept is based on cost-effective and reliable processing of individual interconnection system components. This significantly reduces installation costs of the solar energy system.

The junction box concept is based on a flexible, open system structure, which allows serial as well as parallel interconnection via direct wire connect or separable connectors. Within the junction box, up to six termination places rails are available for photovoltaic foil connection.

The male and female cable coupler was designed for high voltage and high current-carrying capacity in addition to the well-established IP 67 sealing requirement in the photovoltaic industry. Mating safety is provided by polarity keyed housings, fully shrouded contacts, reliable high cycle life, and squeeze to release connection system. In addition, a wide temperature range and fulfillment of worldwide standards for photovoltaic connection systems complement the robust product specification.

The design of the male and female receptacle for the junction box and the DC/AC converter follow the cable coupler "click philosophy" for quick and secure mating even in difficult mounting positions.

If required by the customer, the junction box can be delivered pre-configured with diodes, jumpers, plug connectors, and solar cable pigtailed.

Large Junction Box – Serial Interconnection

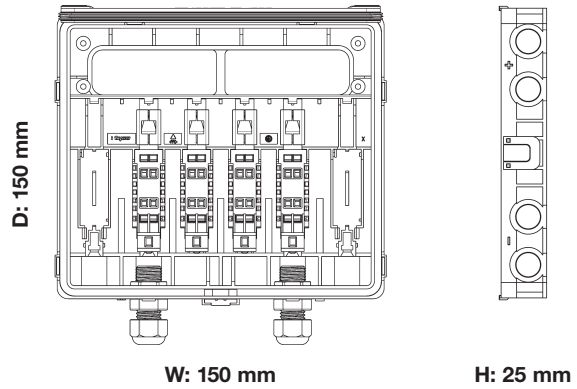

SERIAL INTERCONNECTION							
Configuration	Part Number	Package Quantity	Interconnection Options			Contact Rails	Diodes
			Plug Connector		Direct Wire		
			Plus Keyed	Minus Keyed			
	1-1394723-6	20			□□	□□□□□	
	2-1394723-6	20			□□	□□□□□	□□□□
	1394723-4	20			□□	□□□□□	
	1394723-3	20	□	□		□□□□□	

Large Junction Box – Parallel Interconnection

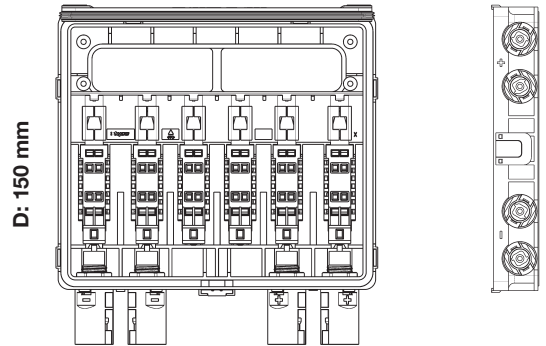

D: 150 mm

W: 150 mm

H: 25 mm

PARALLEL INTERCONNECTION							
Configuration	Part Number	Package Quantity	Interconnection Options			Contact Rails	Diodes
			Plug Connector		Direct Wire		
			Plus Keyed	Minus Keyed			
	1394723-5	20	☐	☐		□□□□□□	
	1394723-6	20			□□□□	□□□□□□	
	1394723-9	20			□□□□	□□□□	

Medium Junction Box – Serial Interconnection

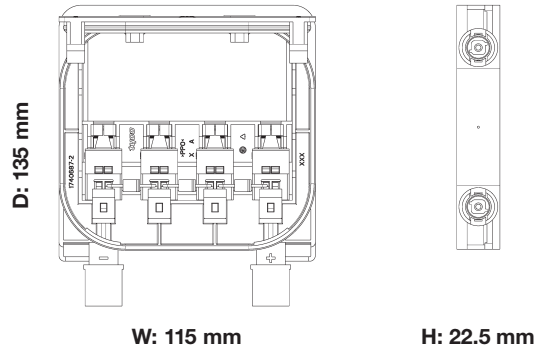

SERIAL INTERCONNECTION							
Configuration	Part Number	Package Quantity	Interconnection Options			Contact Rails	Diodes
			Plug Connector		Direct Wire		
			Plus Keyed	Minus Keyed			
	1740699-1	60			□□	□□□□	□□□ SL1010
	1740699-6*	35			□□	□□□□	□□□ SL1010
	1740700-1	60	□	□		□□□□	□□□ SL1010
	1740700-3**	35	□	□		□□□□	□□□ SL1010
	1740971-1	60			□□	□□□□	□□□ SL1515
	1740971-2*	35			□□	□□□□	□□□ SL1515
	1740972-1	60	□	□		□□□□	□□□ SL1515
	1740972-3**	35	□	□		□□□□	□□□ SL1515

\*) Junction Box Assembly with two 100 cm long 4.0 mm<sup>2</sup> black solar cable and plug connector.

\*\*\*) Junction Box Assembly with one 200 cm long 4.0 mm<sup>2</sup> black solar cable and two plug connectors.

Medium Junction Box – Serial Interconnection (continued)

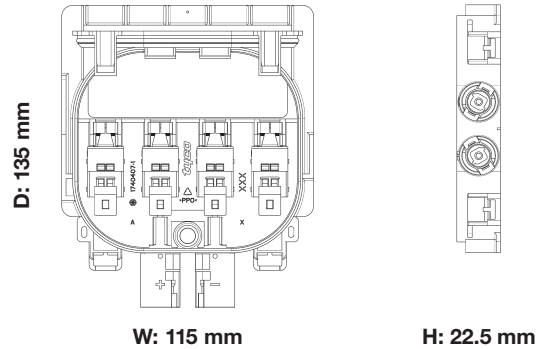

SERIAL INTERCONNECTION							
Configuration	Part Number	Package Quantity	Interconnection Options			Contact Rails	Diodes
			Plug Connector		Direct Wire		
			Plus Keyed	Minus Keyed			
	1740657-7	60			□□	□□□□	□□ SL1010 □ SL1515
	1740657-8*	35			□□	□□□□	□□ SL1010 □ SL1515
	1740658-1	60	□	□		□□□□	□□ SL1010 □ SL1515
	1740658-3**	35	□	□		□□□□	□□ SL1010 □ SL1515
	1740657-9	60			□□	□□□□	□□□ SL1515
	1-1740657-0*	35			□□	□□□□	□□□ SL1515
	1740658-4	60	□	□		□□□□	□□□ SL1515
	1740658-5**	35	□	□		□□□□	□□□ SL1515

\* ) Junction Box Assembly with two 100 cm long 4.0 mm<sup>2</sup> black solar cable and plug connector.  
 \*\* ) Junction Box Assembly with one 200 cm long 4.0 mm<sup>2</sup> black solar cable and two plug connectors.

Small Junction Box – Serial Interconnection

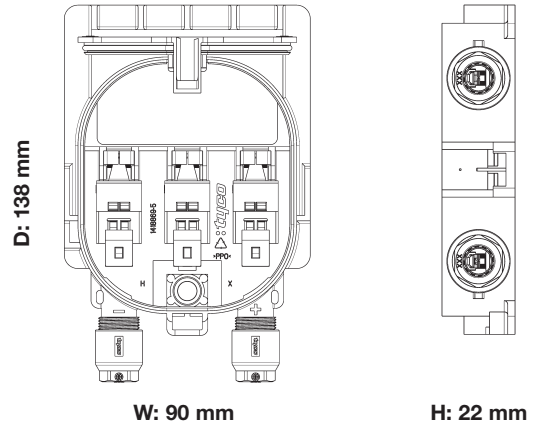

SERIAL INTERCONNECTION							
Configuration	Part Number	Package Quantity	Interconnection Options			Contact Rails	Diodes
			Plug Connector		Direct Wire		
			Plus Keyed	Minus Keyed			
	1740220-4	80			□□	□□	
	1740220-2	80			□□	□□	□
	1740425-3*	48			□□	□□	□
	1740220-3	80			□□	□□□	
	1740220-1	80			□□	□□□	□□
	1740425-1**	48			□□	□□□	□□

\*) Junction Box Assembly with two 70 cm long 4.0 mm<sup>2</sup> black solar cable and plug connector.

\*\*\*) Junction Box Assembly with two 85 cm long 4.0 mm<sup>2</sup> black solar cable and plug connectors.



Small Junction Box – Serial Interconnection (continued)

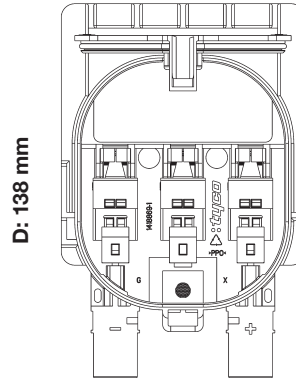

W: 90 mm

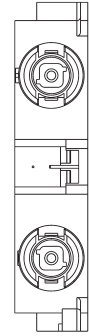

H: 22 mm

SERIAL INTERCONNECTION							
Configuration	Part Number	Package Quantity	Interconnection Options			Contact Rails	Diodes
			Plug Connector		Direct Wire		
			Plus Keyed	Minus Keyed			
	1418867-2	80	<input type="checkbox"/>	<input type="checkbox"/>		□□	
	1418867-5	80	<input type="checkbox"/>	<input type="checkbox"/>		□□	□
	1-1418867-3*	48	<input type="checkbox"/>	<input type="checkbox"/>		□□	□
	1418867-1	80	<input type="checkbox"/>	<input type="checkbox"/>		□□□	
	1418867-6	80	<input type="checkbox"/>	<input type="checkbox"/>		□□□	□□
	1-1418867-2**	48	<input type="checkbox"/>	<input type="checkbox"/>		□□□	□□

\*) Junction Box Assembly with one 140 cm long 4.0 mm<sup>2</sup> black solar cable and two plug connectors.

\*\*\*) Junction Box Assembly with one 170 cm long 4.0 mm<sup>2</sup> black solar cable and two plug connectors.

**Mini Junction Box – Serial Interconnection**

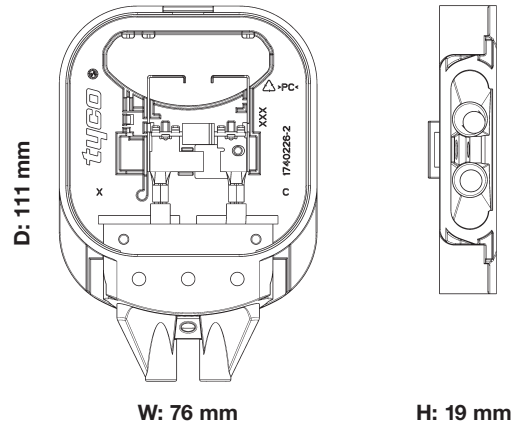



**SERIAL INTERCONNECTION**

Configuration	Part Number	Package Quantity	Contact Rail Shape	Direct Wire	Contact Rails	Diodes
	1740863-1*	80	Straight	□□	□□	□
	1740863-2*	80	Right-Angle	□□	□□	□



\*) Junction Box Assembly with two 85 cm long 4.0 mm<sup>2</sup> black solar cable and plug connector.

Cable Coupler



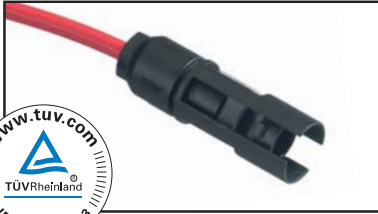

Wire Size (mm <sup>2</sup> )	Female Cable Coupler		Male Cable Coupler		Package Quantity
	Plus Keyed	Minus Keyed	Plus Keyed	Minus Keyed	
2.5	1394462-1	1394462-2	1394461-1	1394461-2	100
4.0	1394462-3	1394462-4	1394461-3	1394461-4	100
6.0	5-1394462-5	5-1394462-6	6-1394461-5	6-1394461-6	100

**Male Cable Coupler Not Keyed, only for Junction Box Serial Interconnection**

Wire Size (mm <sup>2</sup> )	Male Cable Coupler	Package Quantity
2.5	6-1394461-1	100
4.0	6-1394461-2	100
6.0	6-1394461-4	100



**Cable Coupler with Connector Latch Locking Clip**

Connector Latch Locking Clip	Package Quantity
1534226-1	100

T-Branch Connector

Parallel Interconnection using T-Branch Connector (Male-to-Male)



T-Branch Connector		Part Number	Package Quantity
Plus Keyed	Minus Keyed		
□		1534611-1	20
	□	1534611-2	20

Parallel Interconnection using T-Branch Connector (Female-to-Male)



T-Branch Connector		Part Number	Package Quantity
Plus Keyed	Minus Keyed		
□		1740277-1	20
	□	1740277-2	20



DC/AC Converter Receptacle



O-Ring and Metal Nut



Flat Seal and Plastic Nut



With Cover

Wire Size		Keying		Part Number	Package Quantity	Remarks
2.5 mm <sup>2</sup> (AWG 14)	4.0 mm <sup>2</sup> (AWG 12)	Plus	Minus			
<input type="checkbox"/>		<input type="checkbox"/>		1394738-1	100	O-Ring and Metal Nut
<input type="checkbox"/>			<input type="checkbox"/>	1394738-2	100	
	<input type="checkbox"/>	<input type="checkbox"/>		1394738-3	100	
	<input type="checkbox"/>		<input type="checkbox"/>	1394738-4	100	

<input type="checkbox"/>		<input type="checkbox"/>		1740210-1	100	Flat Seal and Plastic Nut – Black
<input type="checkbox"/>			<input type="checkbox"/>	1740210-2	100	
	<input type="checkbox"/>	<input type="checkbox"/>		1740210-3	100	
	<input type="checkbox"/>		<input type="checkbox"/>	1740210-4	100	
<input type="checkbox"/>		<input type="checkbox"/>		1740210-7	100	Flat Seal and Plastic Nut – Red
<input type="checkbox"/>			<input type="checkbox"/>	1740210-8	100	Flat Seal and Plastic Nut – Blue
	<input type="checkbox"/>	<input type="checkbox"/>		1740210-9	100	Flat Seal and Plastic Nut – Red
	<input type="checkbox"/>		<input type="checkbox"/>	1-1740210-0	100	Flat Seal and Plastic Nut – Blue





<input type="checkbox"/>	<input type="checkbox"/>	<input type="checkbox"/>	<input type="checkbox"/>	1394739-1	100	Cover
--------------------------	--------------------------	--------------------------	--------------------------	-----------	-----	-------

## AC Inverter Connector

## Product Facts

- **Current Rating:**  
30 A
- **Voltage Rating:**  
400 V
- **Protection Degree:**  
IP67 (mated)
- **No. of Positions:**  
5 Poles
- **Temperature Range:**  
-40 °C up to +50 °C
- **Wire Size Range:**  
2.5–6.0 mm<sup>2</sup>
- **Approvals:**
  - VDE certified
  - UL pending



Configuration	5 Pole	Cable Length 200 mm (5 x 4 mm <sup>2</sup> )	Metall Nut	Plastic Nut	Part Number	Package Quantity
	<input type="checkbox"/>	<input type="checkbox"/>	<input type="checkbox"/>		1740483-1	24
	<input type="checkbox"/>	<input type="checkbox"/>		<input type="checkbox"/>	1740483-2	24
	<input type="checkbox"/>				1740479-1	24
	<input type="checkbox"/>	<input type="checkbox"/>	<input type="checkbox"/>		1740493-1	24
	<input type="checkbox"/>	<input type="checkbox"/>		<input type="checkbox"/>	1740493-2	24

## Solar Cable

## Product Facts

- Dual wall insulation
- Electron beam cross-linked
- Excellent resistance to UV, water, ozone, fluids, salt, general weathering
- Excellent resistance to abrasion
- Halogen free, flame retardant, low toxicity
- Very low smoke emissions
- Excellent flexibility and stripping performance
- Wire size from 2.5 mm<sup>2</sup> up to 6.0 mm<sup>2</sup>

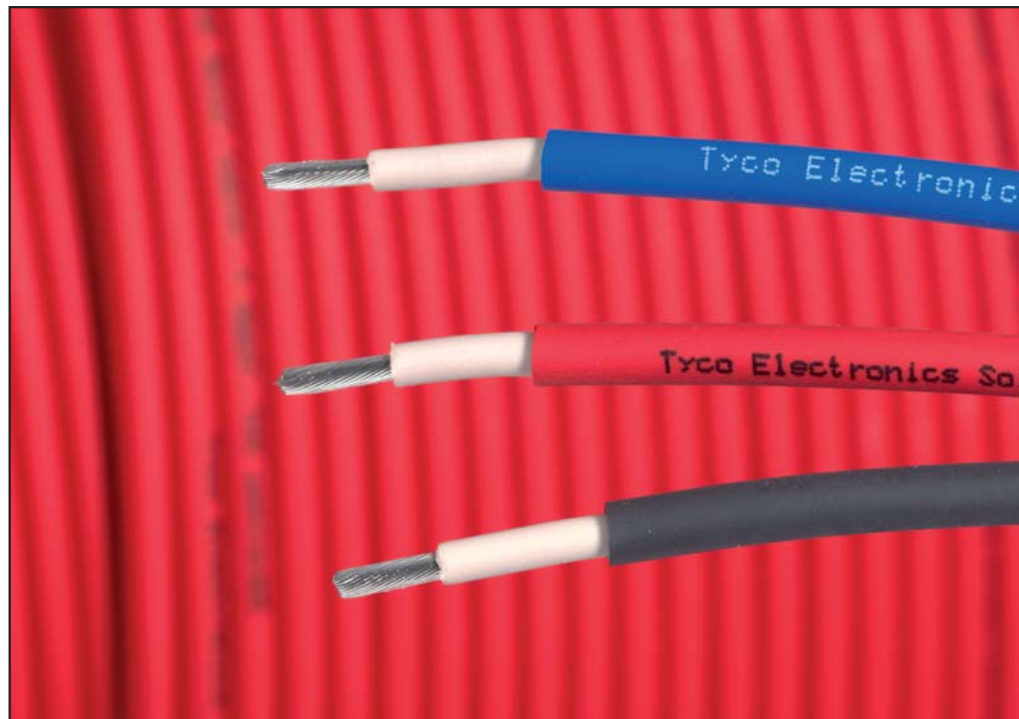

As part of expanding the SOLARLOK Product Line, Tyco Electronics has specified a wire that is designed to meet the harsh environmental conditions typical in the wiring of photovoltaic installations.

The flexible, dual wall, halogen free and cross linked solar wire offers long term stability and TÜV approval.

Its outstanding features include: high resistance against environmental conditions like humidity, UV-radiation and ozone.

In addition, it has excellent resistance to abrasion and temperature extremes.

The wire has a high dielectric withstand voltage and with its fine-stranded, tin plated copper conductor, it is easy to handle and to strip.

## Standards

## Approval:

- IEC 60228 Class 5 (stranded tin plated copper and flexible);
- TÜV certified acc. to 2Pfg 1169/08.2007



## Material and Finish

## Conductor:

Stranded tin plated copper

## Insulation:

Electron beam cross-linked Polyolefin

## Sheath:

Electron beam cross-linked halogen free Polyolefin

## Color:

Black, blue, red

## Mechanical Features

## Max. Conductor Temperature

**Continuous:** +120 °C

**At Short Circuit:** +250 °C

## Min. Operating Temperature

**Free Installation:** -25 °C

**Fixed Installation:** -40 °C

## Wire Size Range:

2.5 mm<sup>2</sup> (AWG 14),

4.0 mm<sup>2</sup> (AWG 12),

6.0 mm<sup>2</sup> (AWG 10)

## Min. Bending Radius:

5 x cable wire diameter, fixed installation

## Electrical Features

Voltage Rating U<sub>0</sub>/U:

1800/3000 V AC / 2600 V DC

## Test Voltage for 5 Minutes:

6000 V

## Max. Current Carrying Capacity (Free in Air):

36 A up to 116 A (size dependent)

## Solar Cable, 1-Pole

**Tyco Electronics  
Solar Cable, 1-Pole**

- TÜV approved
- UL approved



Wire Size Range		Outer Diameter		Color	Part Number	Package Quantity		Approbation
(mm <sup>2</sup> )	(AWG)	(mm)	(Inch)			(m)	(Feet)	TÜV
2.5	-	5.1	0.20	Black	956297-4	500	-	<input type="checkbox"/>
					1-956297-4	100	-	<input type="checkbox"/>
				Red	956297-5	500	-	<input type="checkbox"/>
					1-956297-5	100	-	<input type="checkbox"/>
				Blue	956297-6	500	-	<input type="checkbox"/>
					1-956297-6	100	-	<input type="checkbox"/>
4.0	-	5.7	0.22	Black	956298-4	500	-	<input type="checkbox"/>
					1-956298-4	100	-	<input type="checkbox"/>
				Red	956298-5	500	-	<input type="checkbox"/>
					1-956298-5	100	-	<input type="checkbox"/>
				Blue	956298-6	500	-	<input type="checkbox"/>
					1-956298-6	100	-	<input type="checkbox"/>
6.0	-	6.2	0.24	Black	956299-4	500	-	<input type="checkbox"/>
					1-956299-4	100	-	<input type="checkbox"/>
				Red	956299-5	500	-	<input type="checkbox"/>
					1-956299-5	100	-	<input type="checkbox"/>
				Blue	956299-6	500	-	<input type="checkbox"/>
					1-956299-6	100	-	<input type="checkbox"/>

Wire Size Range		Outer Diameter		Color	Part Number	Package Quantity		Approbation
(mm <sup>2</sup> )	(AWG)	(mm)	(Inch)			(m)	(Feet)	UL
-	14	-	0.17	Black	1986166-2	-	500	<input type="checkbox"/> *
					1986166-3	-	2500	<input type="checkbox"/> *
-	12	-	0.19	Black	1986165-2	-	500	<input type="checkbox"/> *
					1986165-3	-	1500	<input type="checkbox"/> *
-	10	-	0.21	Black	1986164-2	-	500	<input type="checkbox"/> *
					1986164-3	-	1000	<input type="checkbox"/> *

\*) Technical Data upon request.



## Field Wiring, Switching and Protection

## Product Features

- Modular product concept
- One- /two-pole switches
- Current up to 80 A DC
- Voltage up to 1000 VDC
- Compact, standardized design
- Proven quality

## Switching

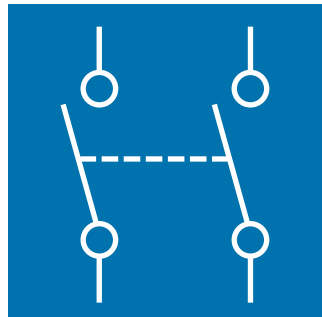

- One- /two-pole switch
- Main switch function
- Lockable
- Current up to 63 A DC
- Voltage up to 900 V  $U_{oc}$

## Collecting

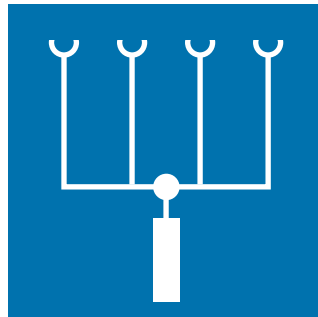

- 1 to 10 strings input
- Cable cross section up to 10 mm<sup>2</sup>
- SOLARLOK connectors
- Various cable glands
- Current up to 80 A DC
- Voltage up to 1000 V DC

## Protecting

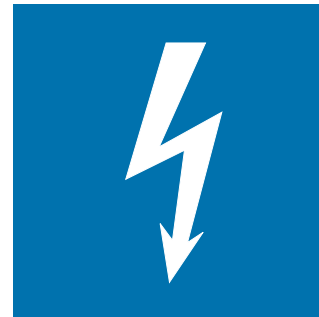

- Lightning protection



## Your Solution



The photovoltaic integrator looks for best fit solutions to wire various types and sizes of solar generators.

The new product concept from Tyco Electronics provides this flexibility to photovoltaic integrators.

The modular product can be comprised of a switch, lightning protection, fuses or any combination of these or other commonly available components.

We can customize a product to fit your specific application. Please contact us with your requirements.

Wiring Example with Extension Cables

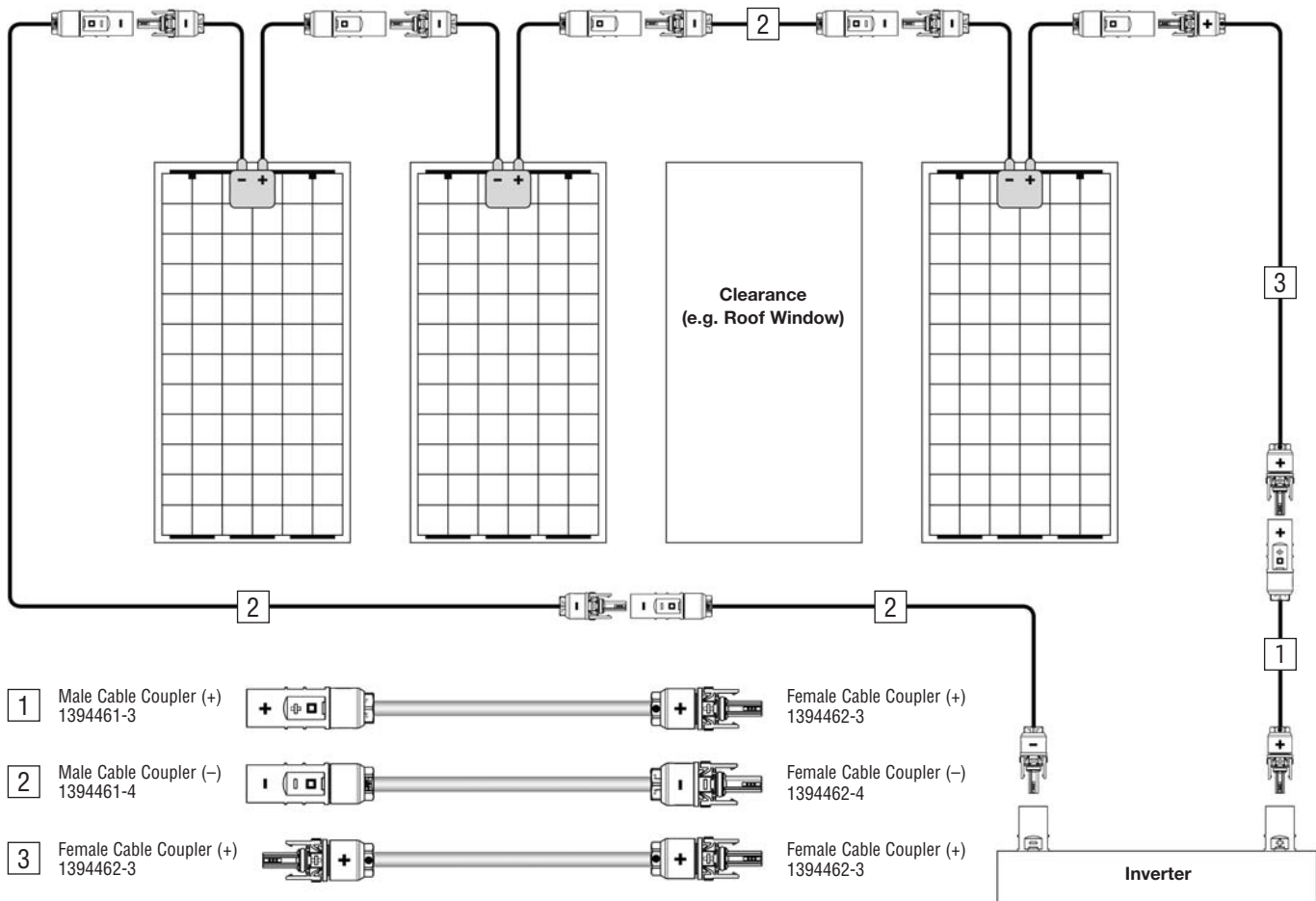

Configuration Example at 4.0 mm<sup>2</sup>.

**Cable Assembly**

**Wire Size:**  
4.0 mm<sup>2</sup>

**Color:**  
Black

Cable Assembly Version	Part Numbers for Cable Length				
	1 m	3 m	5 m	10 m	20 m
1	1987376-1	1987376-2	1987376-3	1987376-4	1987376-5
2	1-1987376-1	1-1987376-2	1-1987376-3	1-1987376-4	1-1987376-5
3	2-1987376-1	2-1987376-2	2-1987376-3	2-1987376-4	2-1987376-5

More variants (cable length, wire diameter, color) upon request.

Wiring Example with Extension Cables (continued)

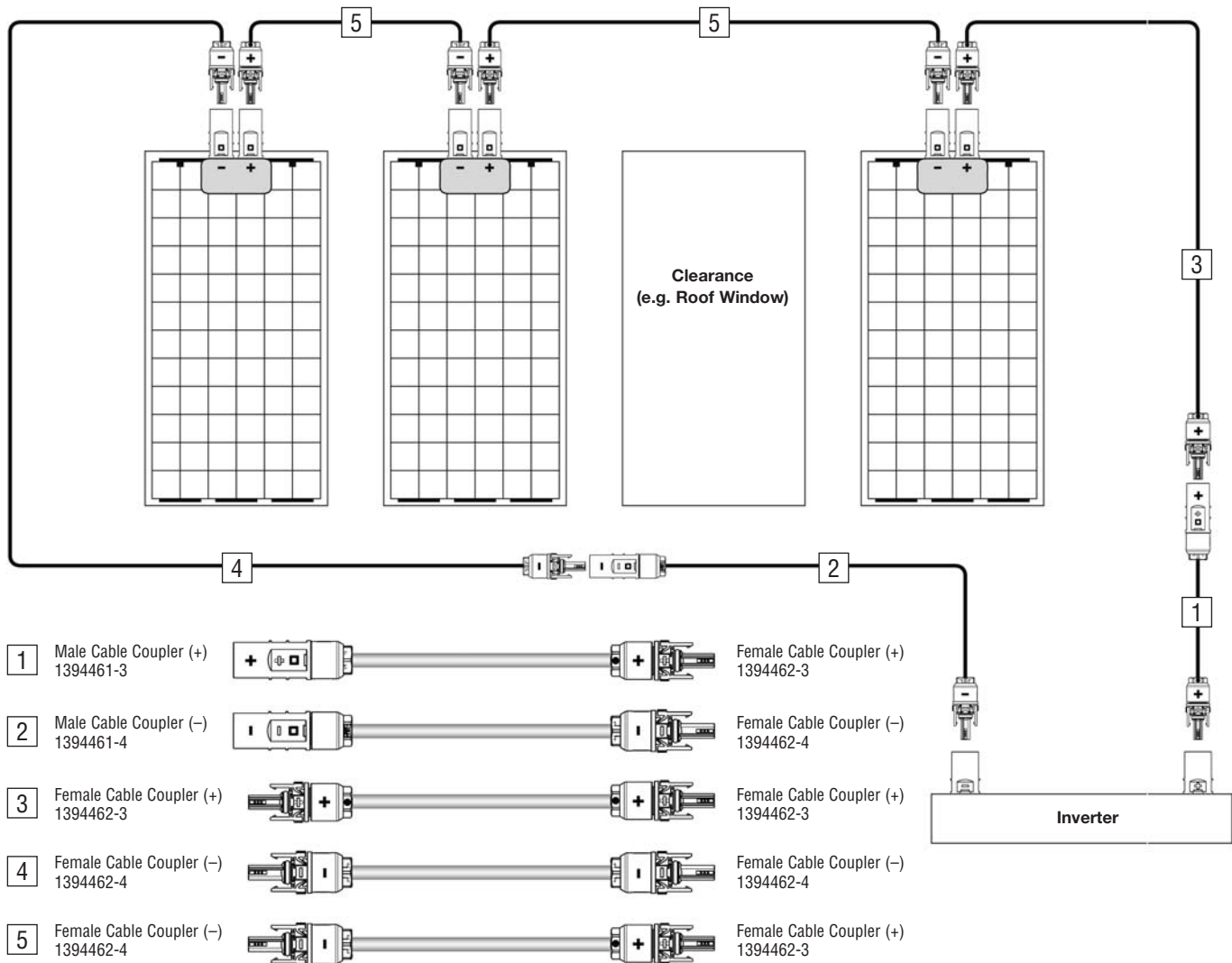

Configuration Example at 4.0 mm<sup>2</sup>.

**Cable Assembly**

**Wire Size:**  
4.0 mm<sup>2</sup>

**Color:**  
Black

Cable Assembly Version	Part Numbers for Cable Length				
	1 m	3 m	5 m	10 m	20 m
1	1987376-1	1987376-2	1987376-3	1987376-4	1987376-5
2	1-1987376-1	1-1987376-2	1-1987376-3	1-1987376-4	1-1987376-5
3	2-1987376-1	2-1987376-2	2-1987376-3	2-1987376-4	2-1987376-5
4	3-1987376-1	3-1987376-2	3-1987376-3	3-1987376-4	3-1987376-5
5	4-1987376-1	4-1987376-2	4-1987376-3	4-1987376-4	4-1987376-5

More variants (cable length, wire diameter, color) upon request.

## SolKlip™ – Ground Clip

## Product Features

- Self-tapping screw
- Quick and easy mounting
- Four-point contact to wire
- Low interface resistance
- Toolless termination
- Re-terminateable up to 5 times
- UV resistant
- Weather-proof
- UL approved
- RoHS compliant

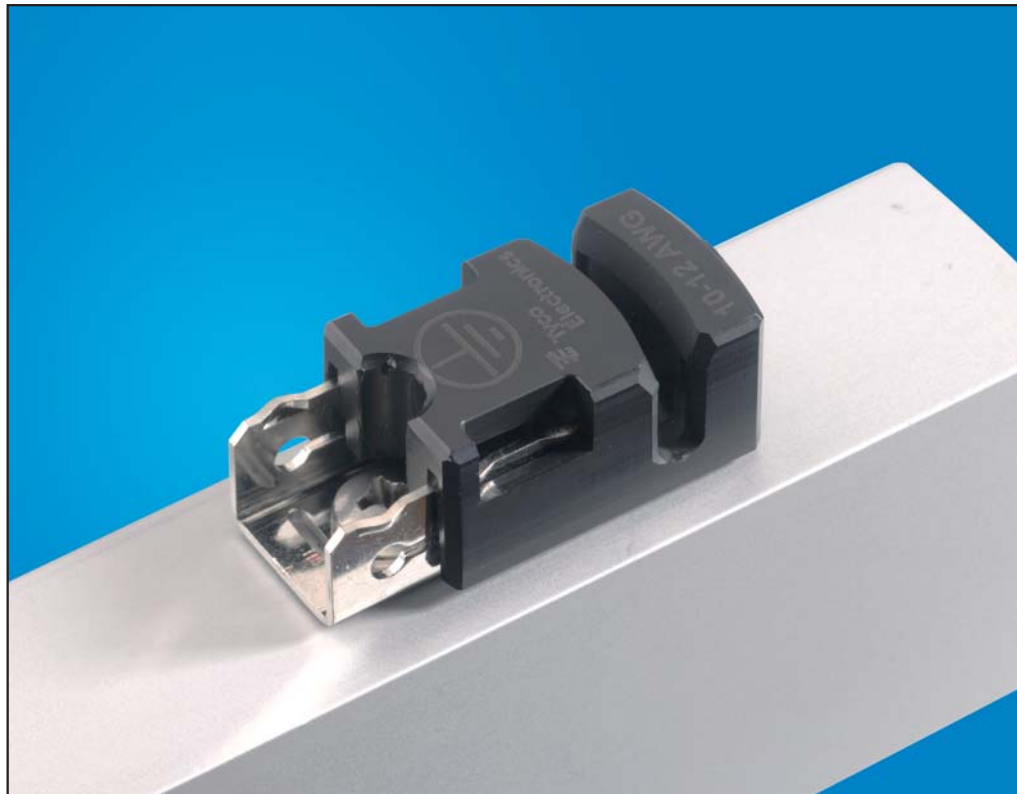

Tyco Electronics' newest innovation provides the photovoltaic integrator with a solution for grounding PV panels and mounting frames. The Tyco Electronics SolKlip brings a new ground connection solution to the market by utilizing well-known insulation displacement termination technology.

Existing solutions typically require the use of ring tongue crimp terminals which have to be crimped first at a specific location on the wire, a hole is then drilled into the mounting surface, and the product is finally mounted on the frame with a separate thread forming or self-tapping screw. The new Tyco Electronics SolKlip provides an extremely simplified solution for terminating a continuous-run ground wire.

Termination times are measured in seconds using the pre-mounted Tyco Electronics SolKlip thereby saving time and reducing wiring costs substantially. The four-point wire contact inherent in the design optimizes grounding performance and provides protection against contact problems due to its low interface resistance.

The Tyco Electronics SolKlip can be used with un-insulated copper wires from 12 AWG to 10 AWG. The retained-force nature of the contact provides a robust interface that minimizes vibration or thermally induced termination problems that often occur with traditional ground-screw connections. Termination of the wire is safely and easily accomplished toollessly by simply inserting the wire and closing the cover.

With a tensile strength of up to 36 kg, the UV-resistant enclosure provides a secure termination even in roughest environmental and assembly conditions. As an added benefit, the connection can be opened and re-terminated again up to five times.

Retrofitting the Tyco Electronics SolKlip on panels or frames can be done at any time by simply by drilling mounting hole in the frame and attaching the terminal to the frame using the integrated, self-tapping screw. This ensures a secure connection with the panel and/or frame.

The patent-pending Tyco Electronics SolKlip ground terminal supplements the existing Tyco Electronics SOLARLOK product portfolio and offers the electrician yet another valuable component for simple and fast wiring of a PV-system.



SolKlip™ – Ground Clip (continued)

3 Easy Steps to Ground Your PV System

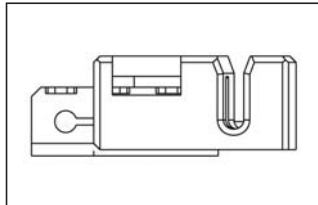

Insert ...

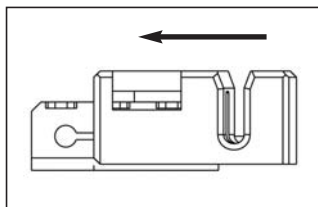

... Push ...

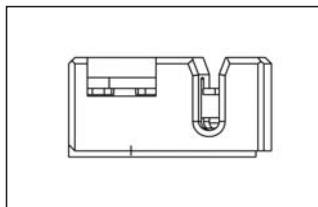

... Ready!

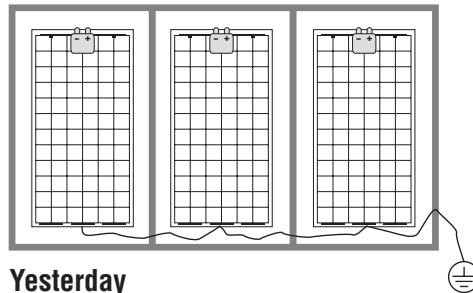

Yesterday

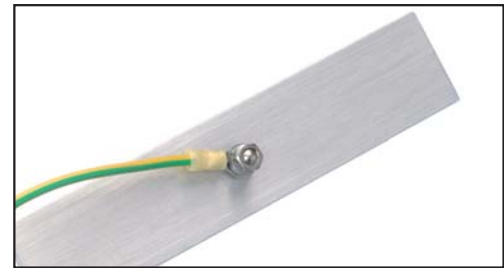

- Screw
- Washer
- Lock Washer
- Ring Tongue
- Screwdriver
- Drill
- Pliers

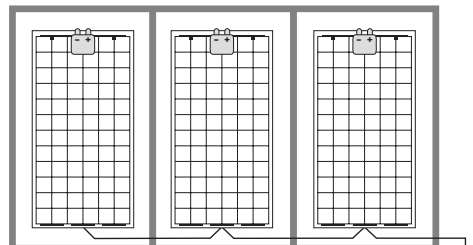

Today

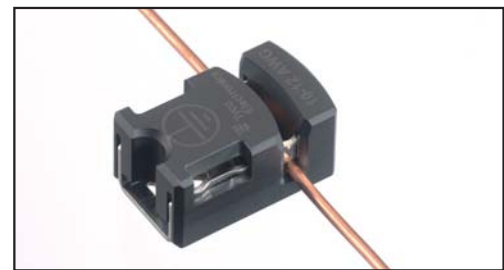

- SolKlip

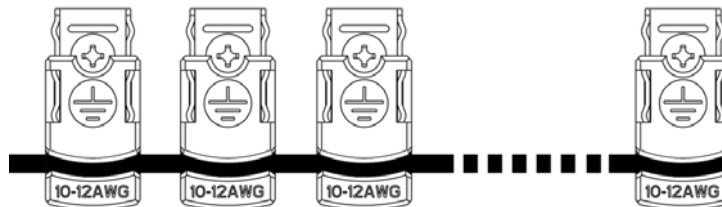

Click Click Click

**Description**

SolKlip ground clips are designed for solar panel grounding applications using solid un-insulated copper 10 AWG and 12 AWG.

**Applications**

Solar panels and related products that require grounding for safety reasons.

Applications include: wire jumpers between solar panels, solar roof tiles and between panels and the AC/DC inverters.

**Electrical**

The electrical performance of this product will meet the tough requirements of photovoltaic grounding applications.

**Product Offering & Dimensions**

SolKlip for Solar Grounding Part No. **1954381-1** to handle 12–10 AWG solid, un-insulated ground wire.

**Application Tooling**

No special tooling required.

**Standards and Specifications**

SolKlip Grounding Clip: UL 467 pending, a requirement for UL 1703 solar panel listing.

UL 486A-B pending, also a requirement as part of the UL 1703 approval listing.

**Materials**

Housing: Durable PPT

Contact: High conductivity copper alloy

**Mechanical**

The mechanical properties of this product will meet the tough requirements for grounding applications laid down in the UL requirements.

Interconnection Examples

**Serial Interconnection for Junction Boxes with Cable Glands  
(4.0 mm<sup>2</sup> Wiring)**

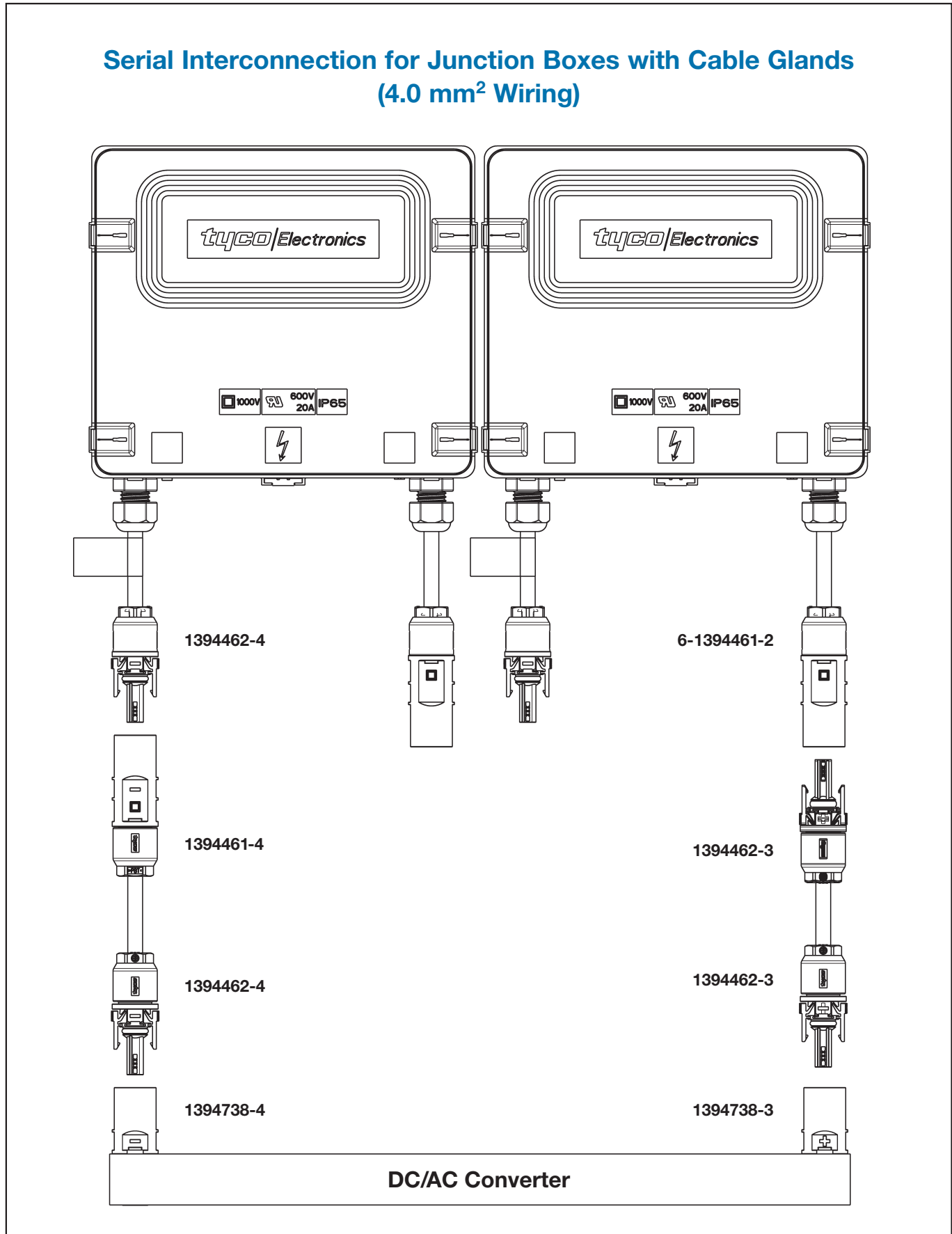

Interconnection Examples (continued)

**Serial Interconnection for Junction Boxes with Plug Connectors  
(4.0 mm<sup>2</sup> Wiring)**

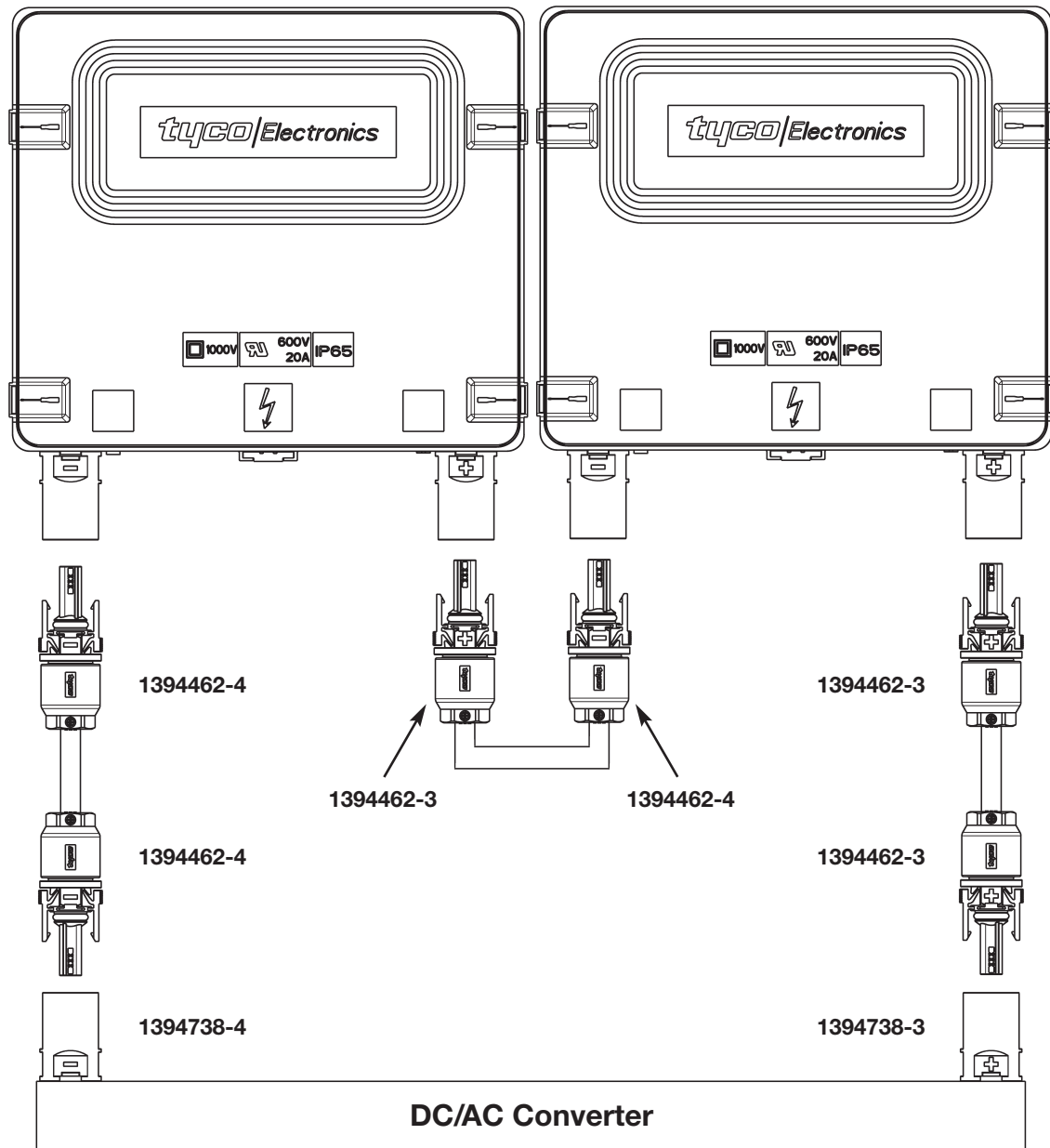

## Application Tooling

## Cable Assembly Tooling

**Hand Crimping Tool**

incl. Vario Crimp Head and Locator

Part Numbers

**1-1579004-1** (1.5 + 2.5 mm<sup>2</sup>)**1-1579004-2** (4.0 + 6.0 mm<sup>2</sup>)**Vario Crimp Head****7-1579001-8** (1.5 + 2.5 mm<sup>2</sup>)**7-1579001-9** (4.0 + 6.0 mm<sup>2</sup>)**Hand Crimping Tool**

incl. Vario Crimp Head and Locator

Part No. **1579004-8**(for 1.5 + 2.5 + 4.0 + 6.0 mm<sup>2</sup>)**Die Set**Part No. **6-1579001-6**(for 1.5 + 2.5 + 4.0 + 6.0 mm<sup>2</sup>)**Extraction Tool**

suitable for all wire sizes

Part No. **1102855-3****Insulation Stripper**includes length stop for all wire sizes: 1.5 mm<sup>2</sup>, 2.5 mm<sup>2</sup>, 4.0 mm<sup>2</sup> and 6.0 mm<sup>2</sup>.

Suitable for Tyco Electronics Solar Cable.

Part No. **4-1579002-2****SOLARLOK  
Electric Terminator CS 200**Base Machine:  
Part No. **539630-1****Adapter for Vario Crimp Head:**Part No. **1579000-4****Vario Crimp Head****(1.5 and 2.5 mm<sup>2</sup>):**Part No. **7-1579001-8****Vario Crimp Head****(4.0 and 6.0 mm<sup>2</sup>):**Part No. **7-1579001-9****Vario Crimp Head (AWG 10):**Part No. **8-1579001-2****Vario Crimp Head (AWG 12):**Part No. **5-1579001-5****Vario Crimpkopf (AWG 14):**Part No. **5-1579001-4**

## Application Tooling (continued)

Junction Box  
Assembly Tooling**Wire Spring Clamp Tool**

Part No. 1579007-2

**Dioden/Jumper  
Spring Clamp Tool**

Part No. 1579007-5

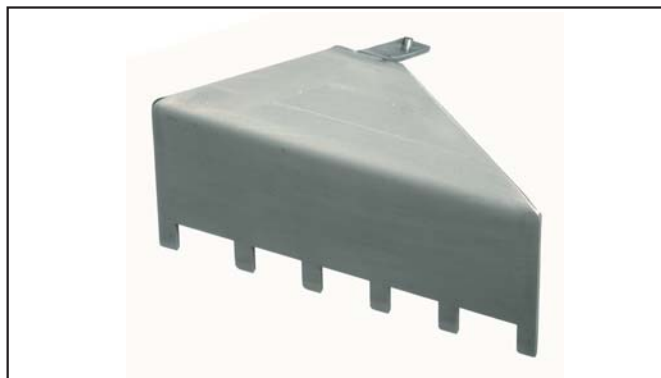
**Foil Spring Clamp Tool**Part No. 1579007-3 Large Box  
Part No. 1740969-1 Medium Box  
Part No. 1740969-2 Small Box**Field Service Kit**Part No. 1534858-1  
(Metric Wire)**Kit includes the following parts:**

- 100 Cable Coupler (Housings, Plus and Minus coded)
- Crimp Contacts (4.0 and 6.0 mm<sup>2</sup>)
- Strain Relief
- Seals
- **Hand Crimp Tool:**  
Part No. 1-1579004-2
- **Extraction Tool:**  
Part No. 1102855-3
- **Insulation Stripper:**  
Part No. 4-1579002-2



## Assembly and Installation Guidelines

Table of Contents	Page
<b>SOLARLOK Plug Connectors</b> .....	24
1. General Comments .....	24
2. Termination of the Cable Wires / Crimping of the Contacts .....	24
3. Handling of the Connectors .....	24
3.1 Selection of Sealing Grommet for Cable Connectors .....	24
3.2 Connector Latching .....	26
3.3 Disconnecting .....	26
3.4 DC/AC Converter Receptacle .....	27
4. <b>Application Examples</b> .....	28
5. <b>Storage</b> .....	28
6. <b>Tooling</b> .....	28

## SOLARLOK Plug Connector

**Attention: This connector is to be used only to interconnect firmly fixed cables.**

**Do not disconnect under load.**

Current path should only be disconnected using approved disconnect devices.

Cable assemblies shall be labeled with Part No. **1394470-1**.

**To protect against shock, ensure that conductors and their associated connectors are separated from opposite polarity components.**

### 1. General Comments

Any kind of pollution (dust, oil, humidity, etc.) during the assembly process or to the unmated connector can degrade contact and connector performance. This applies in particular to the seals and the crimping of the contacts.

A clean assembly environment is therefore essential.

### 2. Termination of the Cable Wires and Crimping of the Contacts

SOLARLOK connectors use different crimp contacts for various wire gauges. Possible wire gauges are 1.5 mm<sup>2</sup>, 2.5 mm<sup>2</sup>, 4.0 mm<sup>2</sup>, 5.3 mm<sup>2</sup> und 6.0 mm<sup>2</sup> resp. AWG 16, AWG 14, AWG 12 and AWG 10.

The tools to be used are selected based upon the wire gauge.

For the application specification, please refer to specification # 114-74013.

### 3. Handling of the Connectors

#### 3.1 Selection of Sealing Grommet for Cable Connectors

Use only appropriate wire gauges.

Besides the standard seal/pinch ring combination further five different seals are available.

- 4.0 mm grommet inner diameter (for insulation diameter from 3.2 to 4.3 mm), Part No. **1394465-5**
- 5.0 mm grommet inner diameter (for insulation diameter from 4.3 to 5.3 mm), Part No. **1394465-1**
- 6.0 mm grommet inner diameter (for insulation diameter from 5.3 to 6.2 mm), Part No. **1394465-2**
- 7.0 mm grommet inner diameter (for insulation diameter from 6.2 to 7.2 mm), Part No. **1394465-3**
- 8.0 mm grommet inner diameter (for insulation diameter from 7.2 to 8.0 mm), Part No. **1394465-4**

The grommet has to be matched with the outer diameter of the solar cable (see customer drawing, Part No. **1394461** and Part No. **1394462**) and the pinch ring (Part No. **1418677-2**) must be applied.

**Assembly and Installation Guidelines (continued)**

When assembling the connectors, the following sequence must be followed:

- ① Stripping the Wire (please refer to application specification # 114-74013)

**Fig. 1**

- ② Insert the stripped wire into the wire crimp barrel until it stops. While holding the wire in place, squeeze tool handles together until ratchet releases.

**Fig. 2**

- ③ Place seal/pinch ring combination into the connector housing until it stops.

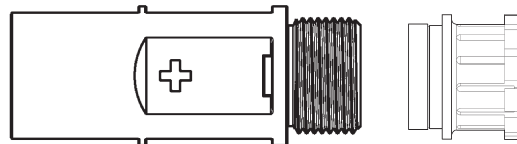
**Fig. 3**

- ④ Place backshell onto the connector housing.

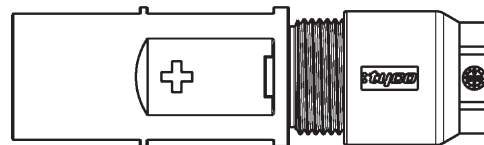
**Fig. 4**

- ⑤ Push contact with cable into the connector housing until you hear the contact is locked into position

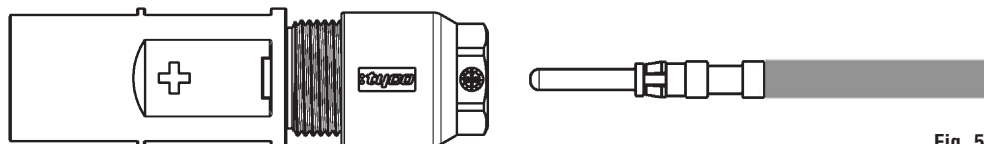
**Fig. 5**

- ⑥ Tighten backshell nut to 1.5 Nm

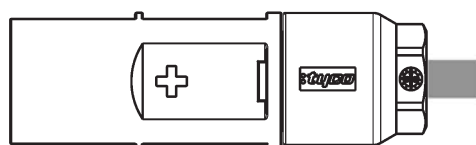
**Fig. 6**

### Assembly and Installation Guidelines (continued)

#### 3.2 Connector Latching

When mating the SOLARLOK connectors, ensure the following:

- Connectors labeled with a plus or minus are keyed and can only be mated to similarly marked and keyed connectors.

**CAUTION:**

The “neutral” designated pin connectors incorporate no keying features and must only be used for Serial Interconnection of Photovoltaic Modules. The neutral product should not be used where maintaining polarity is critical.

The polarity of the “neutral” connector must be labeled with Part No. **1394725-1** or Part No. **1394725-2** nearby the connector.

- The connector system is fully latched only when the latches are flush with the mating connector.
- After the connector is fully latched, the optional latch locking clip may be snapped into place.

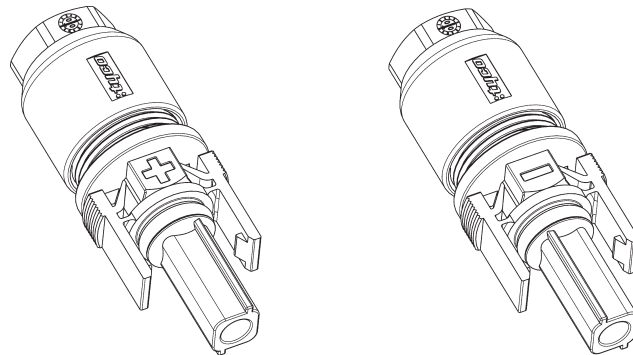

Fig. 7  
(Female Connector)

#### 3.3 Disconnecting

**CAUTION: This connector must not be disconnected under load.**

Disconnect circuit from load before unplugging connectors.

Cable assemblies should be labeled using Tyco Electronics Label, Part No. **1394470-1**.

##### Unmating of the connector

**CAUTION: Do not disconnect the connector under load!**

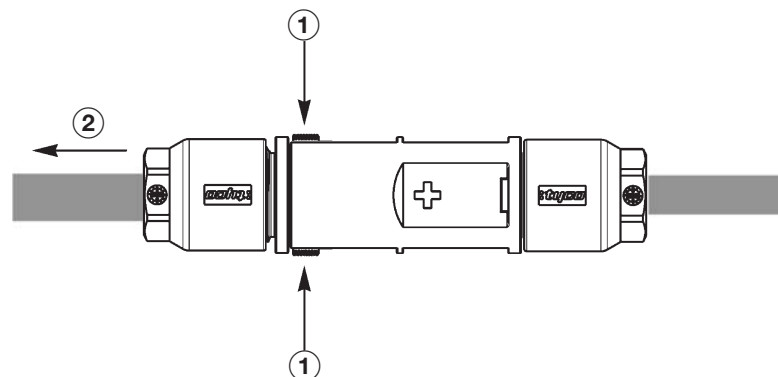

Fig. 8

- ① The locking mechanism is opened by depressing the latches.
- ② Pull out the connectors. While depressing the latches, disconnect the connector by pulling the connector halves apart.

### Assembly and Installation Guidelines (continued)

- 3.4 DC/AC Converter Receptacle** ① Place a single wire seal onto the wire and strip wire (single wire seals are not available with every version).



Fig. 9

- ② Crimp the contact using the correct applicator for the wire gauge (# 114-74013)



Fig. 10

- ③ Place O-ring onto the connector housing; push in wire to stop until contact locks into the housing

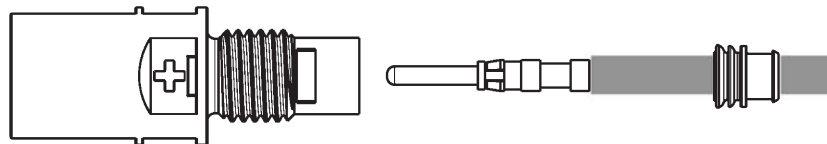

Fig. 11

- ④ Push seal into the housing

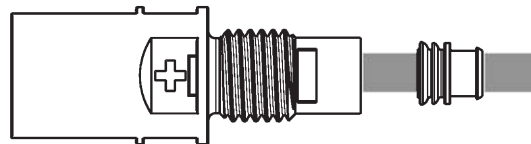

Fig. 12

- ⑤ Assembly of the cover cap (not available with every version) and mounting in front panel

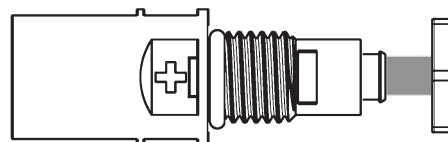

Fig. 13

- Required panel mount hole diameter: Diameter 12.5 mm.
- The panel thickness must not be under 1.0 mm.
- For environmental protection of the unmated connector, use of the covering cap is recommended.

**Cover:**  
Part No. **1394739-1**

---

 Assembly and Installation Guidelines (continued)
 

---

## 4. Application Examples

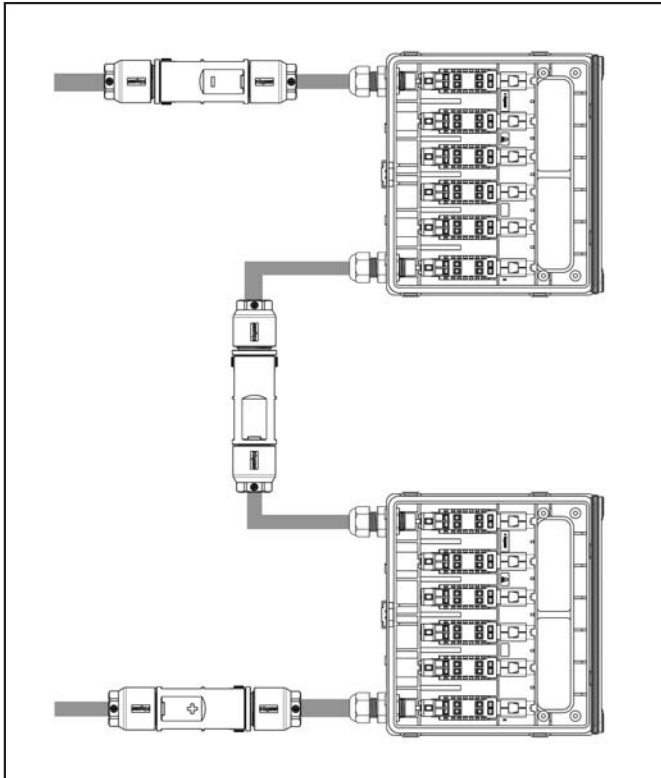

Fig. 14: Serial (Wire Diagram)

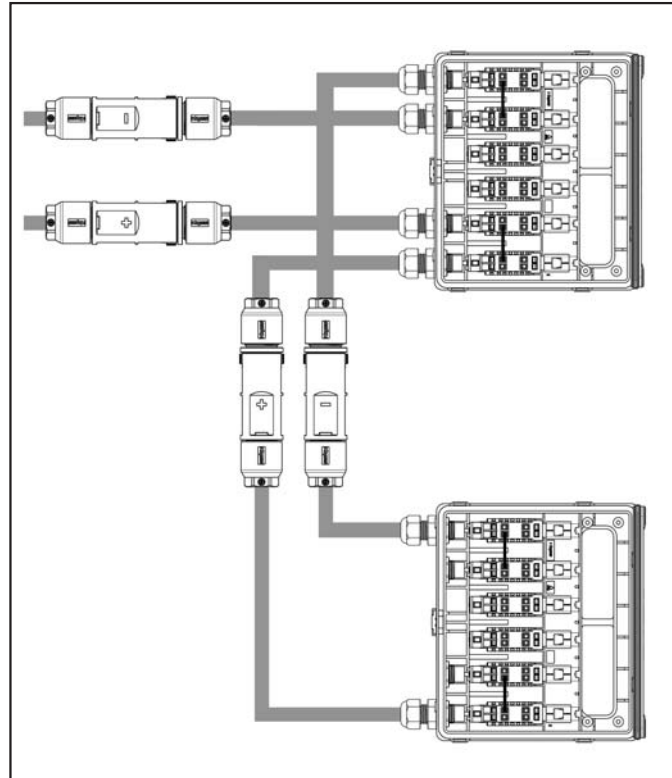

Fig. 15: Parallel (Wire Diagram)

## 5. Storage

See Product Specification 108-18701

## 6. Tooling

- The following tools are available for the contact crimping (please specify wire gauge required):
  - Hand Tool, integral Locator and Die (Part No. **1-1105851-8**), use 'HVT' position on locator
  - Hand Tool, only (Part No. **539973-1**)
- An extraction tool (Part No. **1102855-3**) is needed to disassemble the connector components. This tool is used to unlock the contact retention features, after which the contact can be removed and re-used if necessary.

## Technical Description

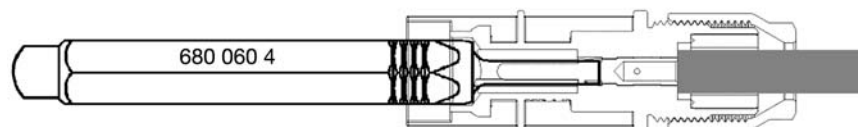

Fig. 16



## Technical Data (Junction Box and One Pole Plug Connectors)

### Materials

Socket and Pin Contacts:	CuZn
Housing:	PPO, weatherproof against UV radiation and ozone

### Color

Connector, Junction Box:	Black
--------------------------	-------

### Electrical Features

Withstanding Voltage:	1000 V DC
Current Rating:	up to 25 A
Contact Resistance:	$\leq 5 \text{ m}\Omega$
Contact Resistance (typical):	1 m $\Omega$
Protection Class:	II

### Mechanical Features

#### Junction Boxes

Dimensions:	Depending on junction box type
Temperature Range:	-40 °C to +105 °C
Wire Size Range:	up to AWG 12
Protection Degree:	IP 65, closed

#### Connector

Dimensions:	Diameter 18 mm, (diameter 0.71 inch)
Temperature Range:	-40 °C to +105 °C
Wire Size Range:	AWG 14, AWG 12, AWG 10 stranded wire
Protection Degree:	IP 67, mated
Contact Finish:	silver plated,
Mating Cycles:	50, silver plated
Unmating Force:	30–40 Newton
Additional Features:	Coded housing ensures mating safety Contact voltage-proof Connector with crimp technology

<b>Standards</b>	IEC 61215 Edition 2, 61646, IEC 61730, Protection Class II, UL 1703
------------------	--

**Subject to Change.**

## Numerical Index

Part Number	Page	Part Number	Page	Part Number	Page	Part Number	Page
539630-1	22	1394470-1	26	1740210-7	11	1987376-2	16, 17
539973-1	28	1394470-1	24	1740210-8	11	1987376-3	16, 17
956297-4	14	1394723-3	2	1740210-9	11	1987376-4	16, 17
956297-5	14	1394723-4	2	1-1740210-0	11	1987376-5	16, 17
956297-6	14	1394723-5	3	1740220-1	6	1-1987376-1	16, 17
1-956297-4	14	1394723-6	3	1740220-2	6	1-1987376-2	16, 17
1-956297-5	14	1394723-9	3	1740220-3	6	1-1987376-3	16, 17
1-956297-6	14	1-1394723-6	2	1740220-4	6	1-1987376-4	16, 17
956298-4	14	2-1394723-6	2	1740277-1	10	1-1987376-5	16, 17
956298-5	14	1394725-1	26	1740277-2	10	2-1987376-1	16, 17
956298-6	14	1394725-2	26	1740425-1	6	2-1987376-2	16, 17
1-956298-4	14	1394738-1	11	1740425-3	6	2-1987376-3	16, 17
1-956298-5	14	1394738-2	11	1740479-1	12	2-1987376-4	16, 17
1-956298-6	14	1394738-3	11, 20, 21	1740483-1	12	2-1987376-5	16, 17
956299-4	14	1394738-4	11, 20, 21	1740483-2	12	3-1987376-1	17
956299-5	14	1394739-1	11, 27	1740493-1	12	3-1987376-2	17
956299-6	14	1418677-2	24	1740493-2	12	3-1987376-3	17
1-956299-4	14	1418867-1	7	1740657-7	5	3-1987376-4	17
1-956299-5	14	1418867-2	7	1740657-8	5	3-1987376-5	17
1-956299-6	14	1418867-5	7	1740657-9	5	4-1987376-1	17
1102855-3	22, 23, 28	1418867-6	7	1-1740657-0	5	4-1987376-2	17
1-1105851-8	28	1-1418867-2	7	1740658-1	5	4-1987376-3	17
1394461-1	9	1-1418867-3	7	1740658-3	5	4-1987376-4	17
1394461-2	9	1534226-1	9	1740658-4	5	4-1987376-5	17
1394461-3	9, 16, 17	1534611-1	10	1740658-5	5		
1394461-4	9, 16, 17, 20	1534611-2	10	1740699-1	4		
		1534858-1	23	1740699-6	4		
6-1394461-1	9	1579000-4	22	1740700-1	4		
6-1394461-2	9, 20	5-1579001-4	22	1740700-3	4		
6-1394461-4	9	5-1579001-5	22	1740863-1	8		
6-1394461-5	9	6-1579001-6	22	1740863-2	8		
6-1394461-6	9	7-1579001-8	22	1740969-1	23		
1394462-1	9	7-1579001-9	22	1740969-2	23		
1394462-2	9	8-1579001-2	22	1740971-1	4		
1394462-3	9, 16, 17, 20, 21	4-1579002-2	22, 23	1740971-2	4		
		1579004-8	22	1740972-1	4		
1394462-4	9, 16, 17, 20, 21	1-1579004-1	22	1740972-3	4		
		1-1579004-2	22, 23	1954381-1	19		
5-1394462-5	9	1579007-2	23	1986164-2	14		
5-1394462-6	9	1579007-3	23	1986164-3	14		
1394465-1	24	1579007-5	23	1986165-2	14		
1394465-2	24	1740210-1	11	1986165-3	14		
1394465-3	24	1740210-2	11	1986166-2	14		
1394465-4	24	1740210-3	11	1986166-3	14		
1394465-5	24	1740210-4	11	1987376-1	16, 17		

## Restriction on the Use of Hazardous Substances (RoHS)

### Restriction on the Use of Hazardous Substances (RoHS)

At Tyco Electronics, we're ready to support your RoHS requirements. We've assessed more than 1.5 million end items/components for RoHS compliance, and issued new part numbers where any change was required to eliminate the restricted materials. Part numbers in this catalog are identified as:

#### RoHS Compliant

Part numbers in this catalog are RoHS Compliant, unless marked otherwise.

These products comply with European Union Directive 2002/95/EC as amended 1 January 2006 that restricts the use of lead, mercury, cadmium, hexavalent chromium, PBB, and PBDE in certain electrical and electronic products sold into the EU as of 1 July 2006.

**Note:** For purposes of this Catalog, included within the definition of RoHS Compliant are products that are clearly "Out of Scope" of the RoHS Directive such as hand tools and other non-electrical accessories.

#### Non-RoHS Compliant

These part numbers are identified with a "◆" symbol. These products do not comply with the material restrictions of the European Union Directive 2002/95/EC.

#### 5 of 6 Compliant

A "●" symbol identifies these part numbers. These products do not fully comply with the European Union Directive 2002/95/EC because they contain lead in solderable interfaces (they do not contain any of the other five restricted substances above allowable limits). However, these products may be suitable for use in RoHS applications where there is an application-based exception for lead in solders, such as the server, storage, or networking infrastructure exemption.

**Note:** Information regarding RoHS compliance is provided based on reasonable inquiry of our suppliers and represents our current actual knowledge based on the information provided by our suppliers. This information is subject to change. For latest compliance status, refer to our website referenced below.

#### Getting the Information You Need

Our comprehensive on-line RoHS Customer Support Center provides a forum to answer your questions and support your RoHS needs. A RoHS FAQ (Frequently Asked Questions) is available with links to more detailed information. You can also submit RoHS questions and receive a response within 24 hours during a normal work week. The Support Center also provides:

- Cross-Reference from Non-compliant to Compliant Products
- Ability to browse RoHS Compliant Products in our on-line catalog: <http://ecommas.tycoelectronics.com/commerce/alt/RohsAltHome.do>
- Downloadable Technical Data Customer Information Presentation
- More detailed information regarding the definitions used above

**RoHS**  
Customer  
Support  
Center 

So whatever your questions when it comes to RoHS, we've got the answers at [www.tycoelectronics.com/leadfree](http://www.tycoelectronics.com/leadfree)



---

Engineering Notes

---

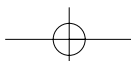

## Americas

**Argentina** – Buenos Aires  
Phone: +54-11-4733-2200  
Fax: +54-11-4733-2211

**Brazil** – São Paulo  
Phone: +55-11-3611-1311  
Fax: +55-11-3611-0397

**Canada** – Toronto  
Phone: +1-905-475-6222  
Fax: +1-905-474-5520  
**Product Information Center:**  
Phone: +1-905-470-4425  
Fax: +1-905-474-5525

**Colombia** – Bogota  
Phone: +57-1-231-9398  
Fax: +57-1-660-0206

**Mexico** – Mexico City  
Phone: +52-55-1106-0800  
+01-800-733-8926  
Fax: +52-55-1106-0901

**For Latin/South American Countries not shown**  
Phone: +54-11-4733-2015  
Fax: +54-11-4733-2083

**United States**  
Harrisburg, PA  
Phone: +1-717-564-0100  
Fax: +1-717-986-7575  
**Product Information Center:**  
Phone: +1-800-522-6752  
Fax: +1-717-986-7575  
Troy, MI  
Phone: +1-248-273-3359  
Fax: +1-248-273-3322

## Asia/Pacific

**Australia** – Sydney  
Phone: +61-2-9554-2600  
Fax: +61-2-9502-2556  
**Product Information Center:**  
Phone: +61-2-9840-8200  
Fax: +61-2-9634-6188

**India** – Bangalore  
Phone: +91-80-285-40800  
Fax: +91-80-285-40820

**Indonesia** – Jakarta  
Phone: +65-6482-0311  
Fax: +65-6482-1012

**Japan** – Kawasaki, Kanagawa  
Phone: +81-44-844-8111  
Fax: +81-44-812-3207  
**Product Information Center:**  
Phone: +81-44-844-8013  
Fax: +81-44-812-3200

**Korea** – Seoul  
Phone: +82-2-3415-4500  
Fax: +82-2-3486-3810

**Malaysia** – Selangor  
Phone: +60-3-7805-3055  
Fax: +60-3-7805-3066

**New Zealand** – Auckland  
Phone: +64-9-634-4580  
Fax: +64-9-634-4586

**Philippines** – Makati City  
Phone: +632-848-0171  
Fax: +632-867-8661

**People's Republic of China**  
Hong Kong  
Phone: +852-2735-1628  
Fax: +852-2735-0243

Shanghai  
Phone: +86-21-2407-1588  
Fax: +86-21-2407-1599

**Singapore** – Singapore  
Phone: +65-6482-0311  
Fax: +65-6482-1012

**Taiwan** – Taipei  
Phone: +886-2-8768-2788  
Fax: +886-2-8768-2268

**Thailand** – Bangkok  
Phone: +66-2-955-0500  
Fax: +66-2-955-0505

**Vietnam** – Ho Chi Minh City  
Phone: +84-8-930-5546  
Fax: +84-8-930-3443

## Europe/Middle East/Africa

**Austria** – Vienna  
Phone: +43-1-905-60-0  
Fax: +43-1-905-60-1333  
**Product Information Center:**  
Phone: +43-1-905-60-1249  
Fax: +43-1-905-60-1251

**Belarus** – Minsk  
Phone: +375-17-237-47-94  
Fax: +375-17-237-47-94

**Belgium** – Kessel-Lo  
Phone: +32-16-352-300  
Fax: +32-16-352-352

**Bulgaria** – Sofia  
Phone: +359-2-971-2152  
Fax: +359-2-971-2153

**Czech Republic and Slovakia**  
**Czech Republic** – Kurim  
Phone: +420-541-162-111  
Fax: +420-541-162-223  
**Product Information Center:**  
Phone: +420-541-162-113  
Fax: +420-541-162-132

**Denmark** – Glostrup  
Phone: +45-43-48-04-00  
Fax: +45-43-44-14-14

**Egypt** – Cairo  
Phone: +202-419-2334  
Fax: +202-417-7647

**Estonia** – Tartu  
Phone: +372-5138-274  
Fax: +372-7400-779

**Finland** – Helsinki  
Phone: +358-95-12-34-20  
Fax: +358-95-12-34-250

**France** – Cergy-Pontoise Cedex  
Phone: +33-1-3420-8888  
Fax: +33-1-3420-8600  
**Product Information Center:**  
Phone: +33-1-3420-8686  
Fax: +33-1-3420-8623

**France Export Divisions** –  
Cergy-Pontoise Cedex  
Phone: +33-1-3420-8804  
Fax: +33-1-3420-8699

**Germany** – Bensheim  
Phone: +49-6251-133-0  
Fax: +49-6251-133-1600  
**Product Information Center:**  
Phone: +49-6251-133-1999  
Fax: +49-6251-133-1988

**Greece** – Athens  
Phone: +30-210-9370-396/397  
Fax: +30-210-9370-655

**Hungary** – Budapest  
Phone: +36-1-289-1000  
Fax: +36-1-289-1010  
**Product Information Center:**  
Phone: +36-1-289-1016  
Fax: +36-1-289-1017

**Ireland** – Dublin  
Phone: +353-1-866-5612  
Fax: +353-1-866-5714

**Israel** – Petach-Tikva  
Phone: +972-3-929-0999  
Fax: +972-3-919-1088

**Italy** – Collegno (Torino)  
Phone: +39-011-4012-111  
Fax: +39-011-4031-116  
**Product Information Center:**  
Phone: +39-011-4012-428  
Fax: +39-011-40-287-428

**Lithuania and Latvia**  
**Lithuania** – Vilnius  
Phone: +370-5-213-1402  
Fax: +370-5-213-1403  
**Product Information Center:**  
Phone: +370-5-211-3016  
Fax: +370-5-213-1403

**Netherlands** – 's-Hertogenbosch  
Phone: +31-73-6246-246  
Fax: +31-73-6212-365  
**Product Information Center:**  
Phone: +31-73-6246-999  
Fax: +31-73-6246-998

**Norway** – Nesbru  
Phone: +47-66-77-88-50  
Fax: +47-66-77-88-55

**Poland** – Warsaw  
Phone: +48-22-4576-700  
Fax: +48-22-4576-720  
**Product Information Center:**  
Phone: +48-22-4576-704  
Fax: +48-22-4576-720

**Romania** – Bucharest  
Phone: +40-21-311-3479/3596  
Fax: +40-21-312-0574

**Russia** – Moscow  
Phone: +7-495-790-7902  
Fax: +7-495-721-1893  
**Product Information Center:**  
Phone: +7-495-790-7902-404  
Fax: +7-495-790-7902-401

**Russia** – St. Petersburg  
Phone: +7-812-718-8192  
Fax: +7-812-718-8193

**Slovenia** – Ljubljana  
Phone: +386-1561-3270  
Fax: +386-1561-3240

**South Africa** – Port Elizabeth  
Phone: +27-41-503-4500  
Fax: +27-41-581-0440

**Spain** – Barcelona  
Phone: +34-93-291-0330  
Fax: +34-93-201-7879

**Sweden** – Upplands Väsby  
Phone: +46-8-50-72-50-00  
Fax: +46-8-50-72-50-01

**Switzerland** – Steinach  
Phone: +41-71-447-0447  
Fax: +41-71-447-0444

**Turkey** – Istanbul  
Phone: +90-212-281-8181-83  
+90-212-282-5130/5430  
Fax: +90-212-281-8184

**Ukraine** – Kiev  
Phone: +380-44-206-2265  
Fax: +380-44-206-2264  
**Product Information Center:**  
Phone: +380-44-206-2265  
Fax: +380-44-206-2264

**United Kingdom** –  
Stanmore, Middlesex  
Phone: +44-8706-080208  
Fax: +44-208-954-6234  
**Product Information Center:**  
Freephone (UK only):  
0800-267-666  
Phone: +44-8706-080208  
Fax: +44-208-420-8095



**Tyco Electronics AMP GmbH**

Siemensstr. 13  
67346 Speyer / Germany  
Phone: +49-(0)6232-30-2520  
Fax: +49-(0)6232-30-2243

[www.tycoelectronics.com](http://www.tycoelectronics.com)  
AMP, SOLARLOK, SOLKLIP, TE Logo and  
Tyco Electronics are trademarks.

© 2008 Tyco Electronics Ltd.  
889753-3 Revised 6-2008 5M ST