



STFW6N120K3, STP6N120K3, STW6N120K3

N-channel 1200 V, 1.95 Ω typ., 6 A SuperMESH3™ Power MOSFET in TO-3PF, TO-220 and TO-247 packages

Datasheet — production data

Features

Order codes	V _{DSS}	R _{DS(on) max}	I _D	P _{tot}
STFW6N120K3	1200 V	< 2.4 Ω	6 A	63 W
STP6N120K3	1200 V	< 2.4 Ω	6 A	150 W
STW6N120K3	1200 V	< 2.4 Ω	6 A	150 W

- 100% avalanche tested
- Extremely large avalanche performance
- Gate charge minimized
- Very low intrinsic capacitances
- Zener-protected

Applications

- Switching applications

Description

These SuperMESH3™ Power MOSFETs are the result of improvements applied to STMicroelectronics' SuperMESH™ technology, combined with a new optimized vertical structure. These devices boast an extremely low on-resistance, superior dynamic performance and high avalanche capability, rendering them suitable for the most demanding applications.

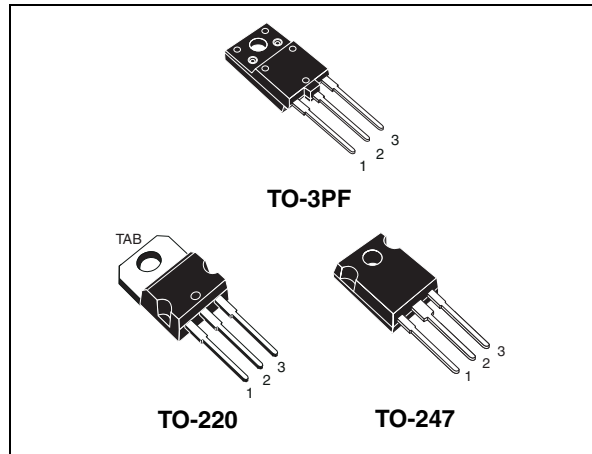

Figure 1. Internal schematic diagram

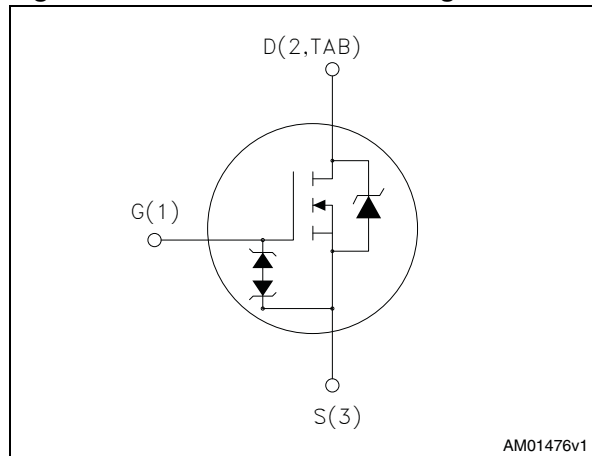

Table 1. Device summary

Order codes	Marking	Package	Packaging
STFW6N120K3	6N120K3	TO-3PF	Tube
STP6N120K3		TO-220	
STW6N120K3		TO-247	

Contents

1	Electrical ratings	3
2	Electrical characteristics	4
	2.1 Electrical characteristics (curves)	6
3	Test circuits	9
4	Package mechanical data	10
5	Revision history	16

1 Electrical ratings

Table 2. Absolute maximum ratings

Symbol	Parameter	Value			Unit
		TO-3PF	TO-220	TO-247	
V_{GS}	Gate- source voltage	± 30			V
I_D	Drain current (continuous) at $T_C = 25\text{ °C}$	6			A
I_D	Drain current (continuous) at $T_C = 100\text{ °C}$	3.8			A
$I_{DM}^{(1)}$	Drain current (pulsed)	20			A
P_{TOT}	Power dissipation at $T_C = 25\text{ °C}$	63	150	150	W
I_{AR}	Max current during repetitive or single pulse avalanche (pulse width limited by T_{JMAX})	7			A
E_{AS}	Single pulse avalanche energy (starting $T_J = 25\text{ °C}$, $I_D = I_{AR}$, $V_{DD} = 50\text{ V}$)	180			mJ
ESD	Gate-source human body model ($C = 100\text{ pF}$, $R = 1.5\text{ k}\Omega$)	6			kV
V_{ISO}	Insulation withstand voltage (RMS) from all three leads to external heat sink ($t = 1\text{ s}$, $T_C = 25\text{ °C}$)	3500			V
T_{stg}	Storage temperature	-55 to 150			°C
T_J	Operating junction temperature				

1. Pulse width limited by safe operating area

Table 3. Thermal data

Symbol	Parameter	Value			Unit
		TO-3PF	TO-220	TO-247	
$R_{thj-case}$	Thermal resistance junction-case	1.98	0.83		°C/W
$R_{thj-amb}$	Thermal resistance junction-ambient max	50	62.5	50	°C/W
T_J	Maximum lead temperature for soldering purpose	300			°C

2 Electrical characteristics

($T_C = 25\text{ °C}$ unless otherwise specified)

Table 4. On / off states

Symbol	Parameter	Test conditions	Min.	Typ.	Max.	Unit
$V_{(BR)DSS}$	Drain-source breakdown voltage	$I_D = 1\text{ mA}$, $V_{GS} = 0$	1200	-	-	V
I_{DSS}	Zero gate voltage drain current ($V_{GS} = 0$)	$V_{DS} = 1200\text{ V}$ $V_{DS} = 1200\text{ V}$, $T_J = 125\text{ °C}$	-	-	1 50	μA μA
I_{GSS}	Gate-body leakage current ($V_{DS} = 0$)	$V_{GS} = \pm 20\text{ V}$	-	-	± 10	μA
$V_{GS(th)}$	Gate threshold voltage	$V_{DS} = V_{GS}$, $I_D = 100\text{ }\mu\text{A}$	3	4	5	V
$R_{DS(on)}$	Static drain-source on-resistance	$V_{GS} = 10\text{ V}$, $I_D = 2.5\text{ A}$	-	1.95	2.4	Ω

Table 5. Dynamic

Symbol	Parameter	Test conditions	Min.	Typ.	Max.	Unit
C_{iss}	Input capacitance	$V_{DS} = 100\text{ V}$, $f = 1\text{ MHz}$, $V_{GS} = 0$	-	1050	-	pF
C_{oss}	Output capacitance			90		pF
C_{rss}	Reverse transfer capacitance			1		pF
$C_{o(tr)}^{(1)}$	Equivalent capacitance time related	$V_{GS} = 0$, $V_{DS} = 0\text{ to }960\text{ V}$	-	40	-	pF
$C_{o(er)}^{(2)}$	Equivalent capacitance energy related	$V_{GS} = 0$, $V_{DS} = 0\text{ to }960\text{ V}$	-	25	-	pF
R_G	Intrinsic gate resistance	$f = 1\text{ MHz}$ open drain	-	3	-	Ω
Q_g	Total gate charge	$V_{DD} = 960\text{ V}$, $I_D = 7.2\text{ A}$, $V_{GS} = 10\text{ V}$ (see Figure 20)	-	39	-	nC
Q_{gs}	Gate-source charge			7.7		nC
Q_{gd}	Gate-drain charge			23.5		nC

1. C_{oss} eq. time related is defined as a constant equivalent capacitance giving the same charging time as C_{oss} when V_{DS} increases from 0 to 80% V_{DSS} .

2. C_{oss} eq. energy related is defined as a constant equivalent capacitance giving the same stored energy as C_{oss} when V_{DS} increases from 0 to 80% V_{DSS} .

Table 6. Switching times on/off

Symbol	Parameter	Test conditions	Min.	Typ.	Max.	Unit
$t_{d(on)}$	Turn-on delay time	$V_{DD} = 600\text{ V}$, $I_D = 3.6\text{ A}$, $R_G = 4.7\ \Omega$, $V_{GS} = 10\text{ V}$ (see Figure 19)	-	30	-	ns
t_r	Rise time			12		ns
$t_{d(off)}$	Turn-off-delay time			58		ns
t_f	Fall time			32		ns

Table 7. Source drain diode

Symbol	Parameter	Test conditions	Min.	Typ.	Max.	Unit
I_{SD}	Source-drain current		-	-	6	A
$I_{SDM}^{(1)}$	Source-drain current (pulsed)				20	A
$V_{SD}^{(2)}$	Forward on voltage	$I_{SD} = 5\text{ A}$, $V_{GS} = 0$	-	--	1.6	V
t_{rr}	Reverse recovery time	$I_{SD} = 7.2\text{ A}$, $di/dt = 100\text{ A}/\mu\text{s}$ $V_{DD} = 60\text{ V}$, $T_J = 25\text{ }^\circ\text{C}$ (see Figure 24)	-	580	-	ns
Q_{rr}	Reverse recovery charge			7		μC
I_{RRM}	Reverse recovery current			25		A
t_{rr}	Reverse recovery time	$I_{SD} = 7.2\text{ A}$, $di/dt = 100\text{ A}/\mu\text{s}$ $V_{DD} = 60\text{ V}$, $T_J = 150\text{ }^\circ\text{C}$ (see Figure 24)	-	840	-	ns
Q_{rr}	Reverse recovery charge			9		μC
I_{RRM}	Reverse recovery current			22		A

1. Pulse width limited by safe operating area.

2. Pulsed: Pulse duration = 300 μs , duty cycle 1.5%

Table 8. Gate-source Zener diode

Symbol	Parameter	Test conditions	Min.	Typ.	Max.	Unit
$V_{(BR)GSO}$	Gate-source breakdown voltage	$I_{GS} = \pm 1\text{ mA}$ ($I_D=0$)	30	-	-	V

The built-in back-to-back Zener diodes have specifically been designed to enhance not only the device's ESD capability, but also to make them safely absorb possible voltage transients that may occasionally be applied from gate to source. In this respect the Zener voltage is appropriate to achieve an efficient and cost-effective intervention to protect the device's integrity. These integrated Zener diodes thus avoid the usage of external components.

2.1 Electrical characteristics (curves)

Figure 2. Safe operating area for TO-3PF

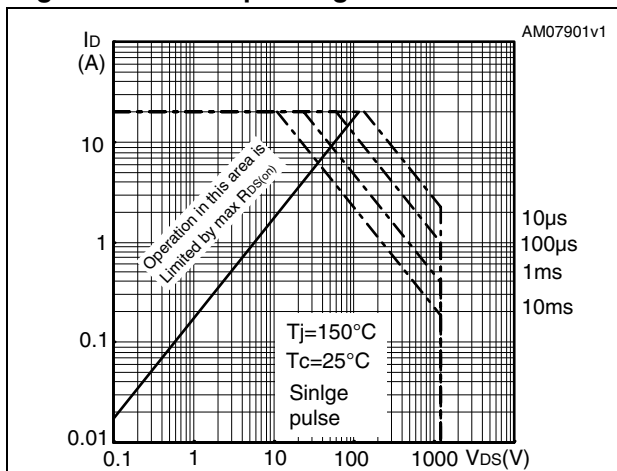

Figure 3. Thermal impedance for TO-3PF

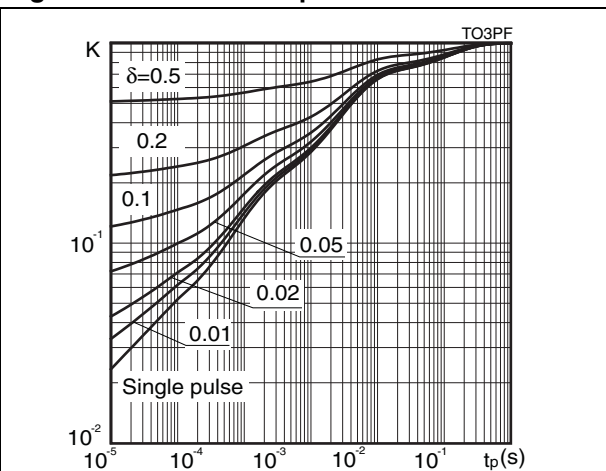

Figure 4. Safe operating area for TO-220

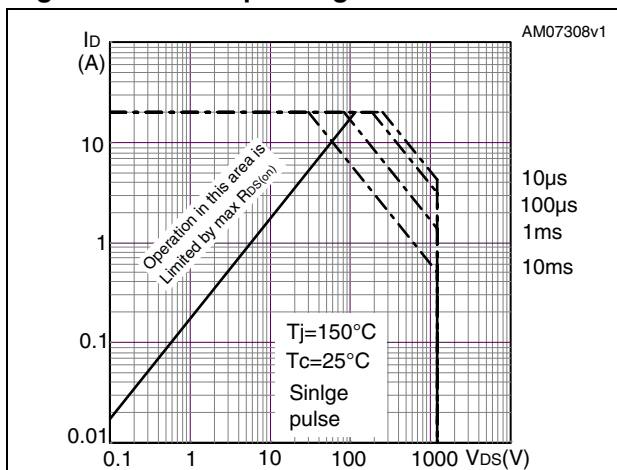

Figure 5. Thermal impedance for TO-220

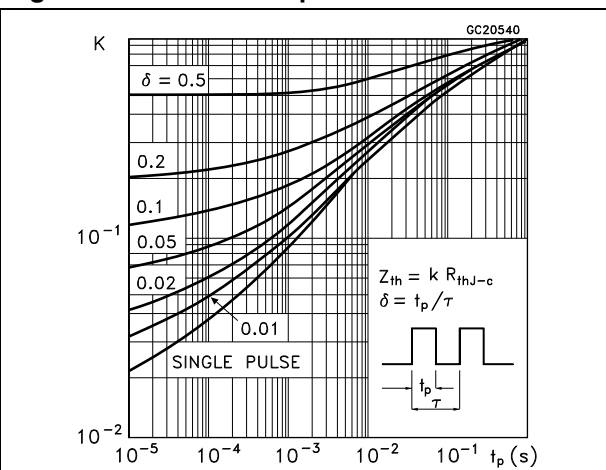

Figure 6. Safe operating area for TO-247

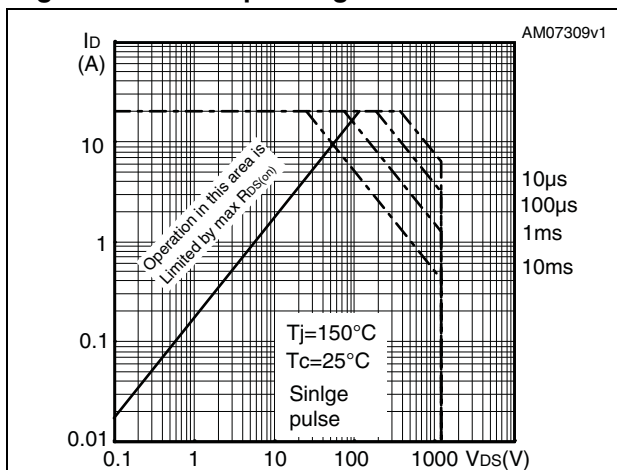

Figure 7. Thermal impedance for TO-247

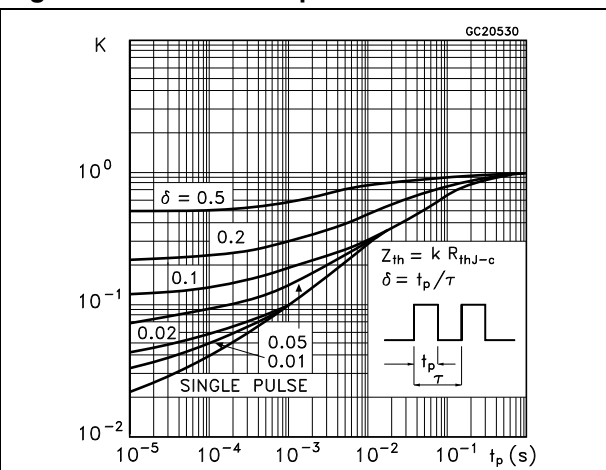

Figure 8. Output characteristics

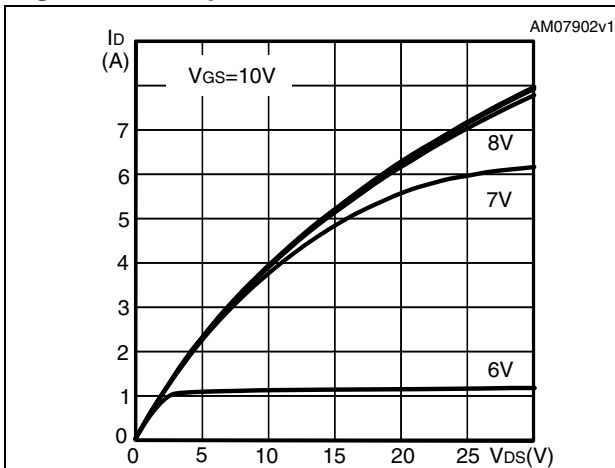

Figure 9. Transfer characteristics

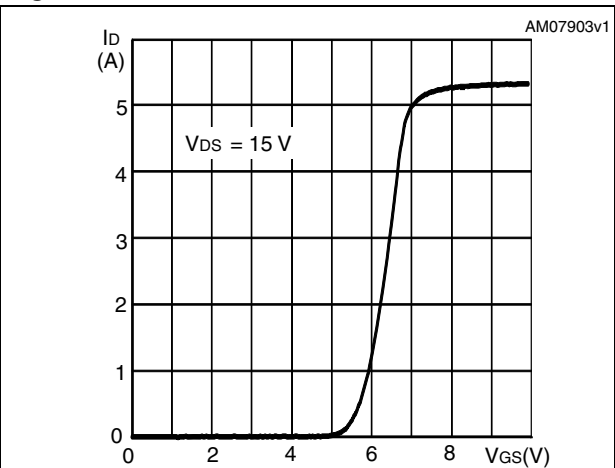

Figure 10. Normalized BV_{DSS} vs temperature

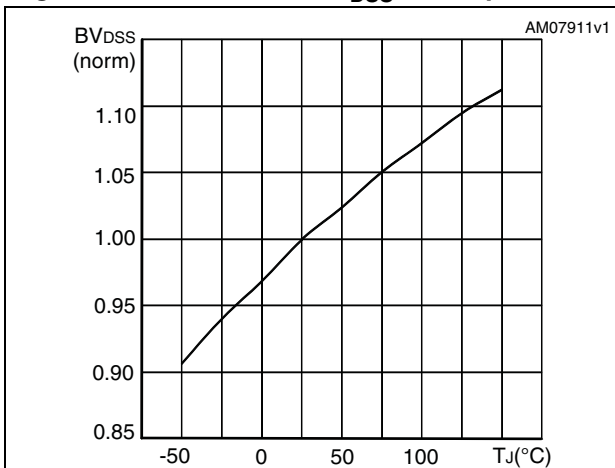

Figure 11. Static drain-source on-resistance

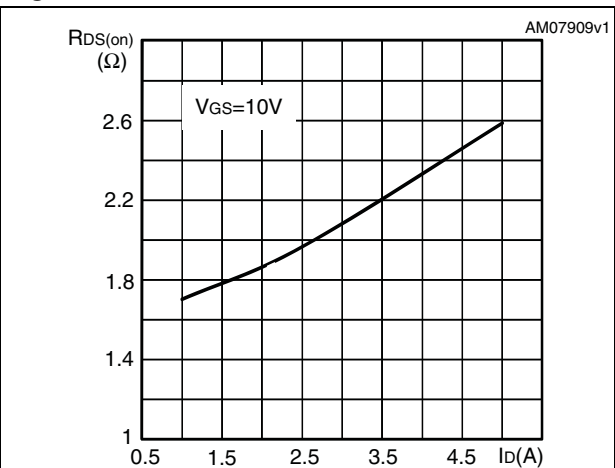

Figure 12. Output capacitance stored energy

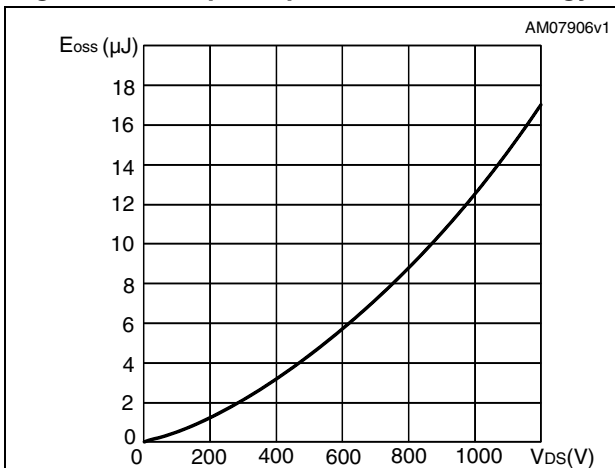

Figure 13. Capacitance variations

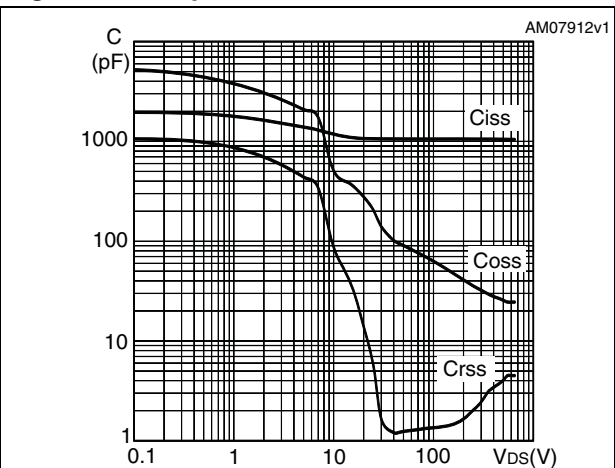

Figure 14. Gate charge vs gate-source voltage Figure 15. Normalized on-resistance vs temperature

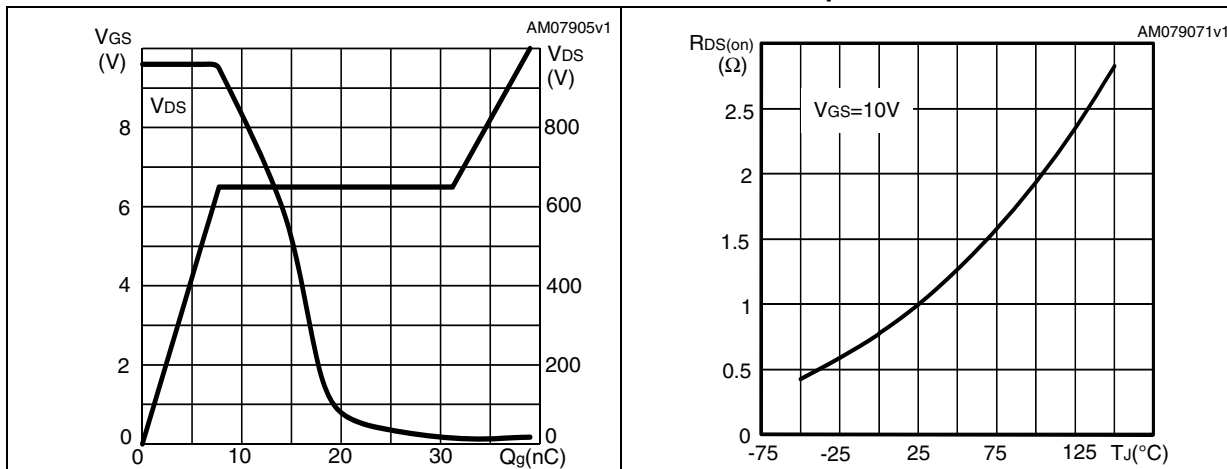

Figure 16. Normalized gate threshold voltage vs temperature Figure 17. Maximum avalanche energy vs temperature

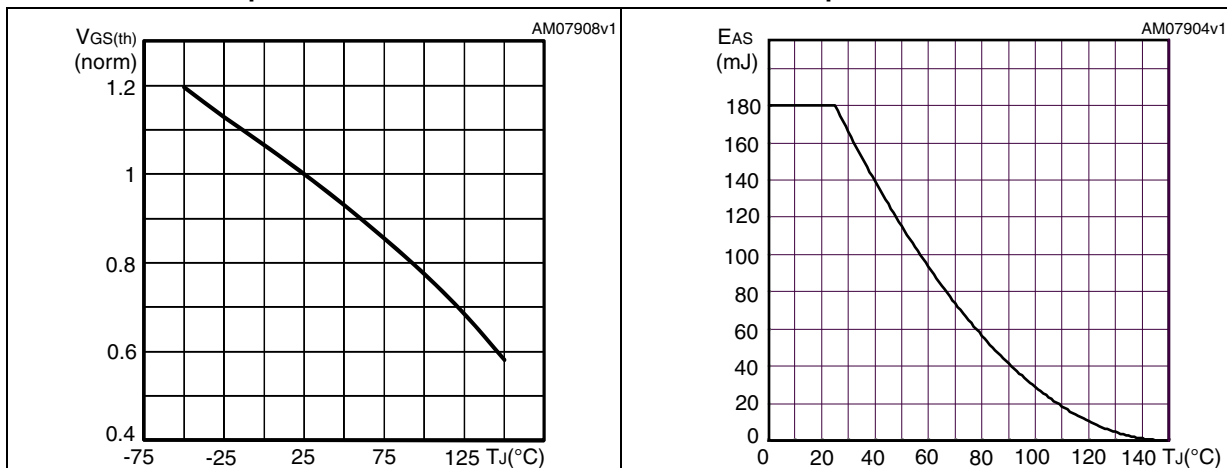
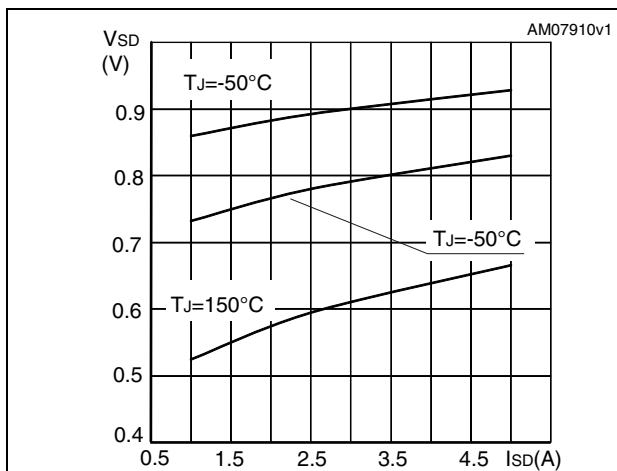

Figure 18. Source-drain diode forward characteristics



3 Test circuits

Figure 19. Switching times test circuit for resistive load



AM01468v1

Figure 20. Gate charge test circuit



AM01469v1

Figure 21. Test circuit for inductive load switching and diode recovery times



AM01470v1

Figure 22. Unclamped inductive load test circuit



AM01471v1

Figure 23. Unclamped inductive waveform

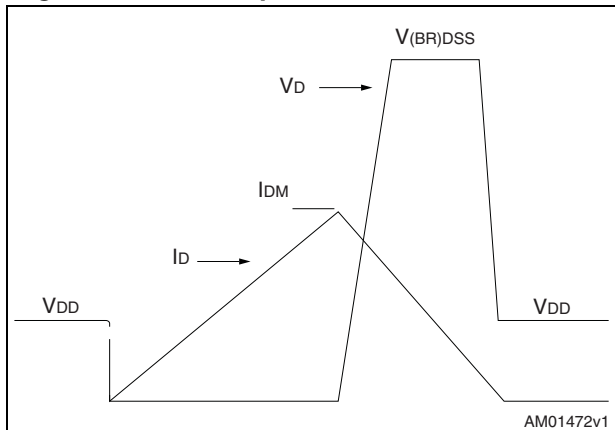

AM01472v1

Figure 24. Switching time waveform

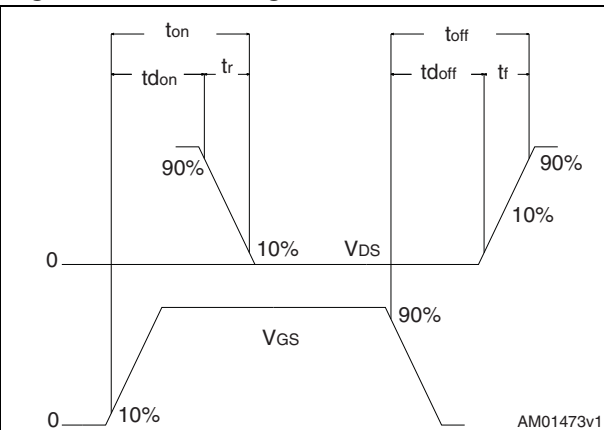

AM01473v1

4 Package mechanical data

In order to meet environmental requirements, ST offers these devices in different grades of ECOPACK[®] packages, depending on their level of environmental compliance. ECOPACK[®] specifications, grade definitions and product status are available at: www.st.com. ECOPACK is an ST trademark.

Table 9. TO-3PF mechanical data

Dim.	mm		
	Min.	Typ.	Max.
A	5.30		5.70
C	2.80		3.20
D	3.10		3.50
D1	1.80		2.20
E	0.80		1.10
F	0.65		0.95
F2	1.80		2.20
G	10.30		11.50
G1		5.45	
H	15.30		15.70
L	9.80	10	10.20
L2	22.80		23.20
L3	26.30		26.70
L4	43.20		44.40
L5	4.30		4.70
L6	24.30		24.70
L7	14.60		15
N	1.80		2.20
R	3.80		4.20
Dia	3.40		3.80

Figure 25. TO-3PF drawing

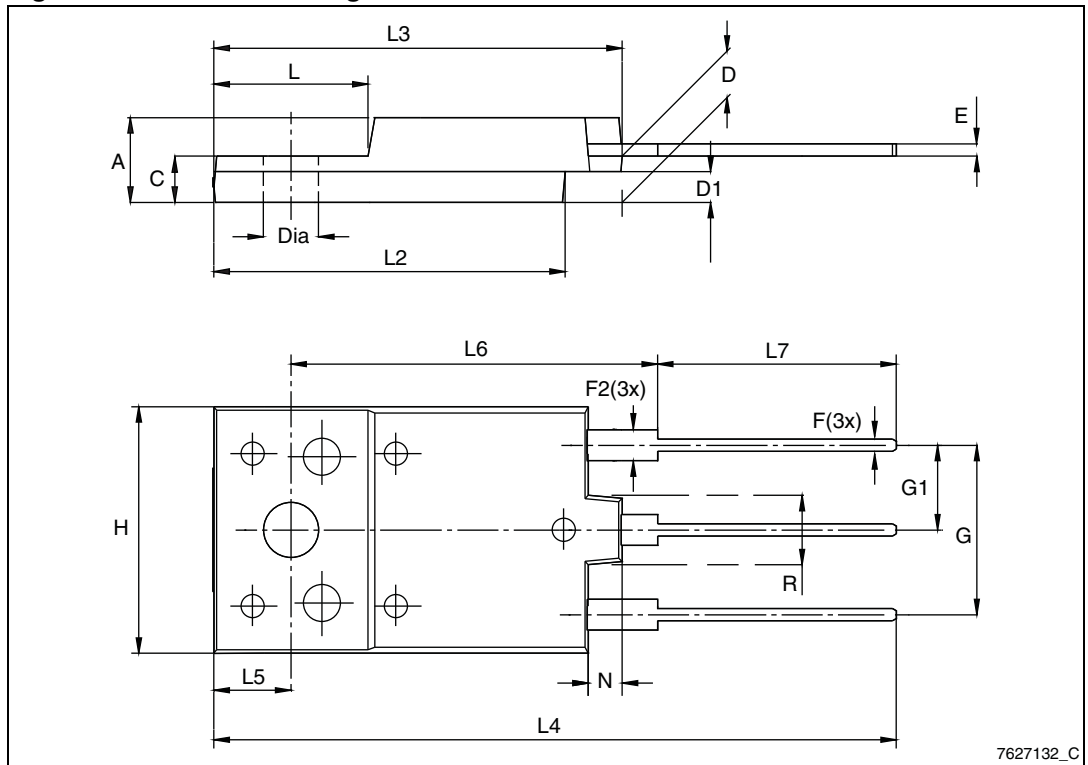

7627132_C

Table 10. TO-220 type A mechanical data

Dim.	mm		
	Min.	Typ.	Max.
A	4.40		4.60
b	0.61		0.88
b1	1.14		1.70
c	0.48		0.70
D	15.25		15.75
D1		1.27	
E	10		10.40
e	2.40		2.70
e1	4.95		5.15
F	1.23		1.32
H1	6.20		6.60
J1	2.40		2.72
L	13		14
L1	3.50		3.93
L20		16.40	
L30		28.90	
ØP	3.75		3.85
Q	2.65		2.95

Figure 26. TO-220 type A drawing

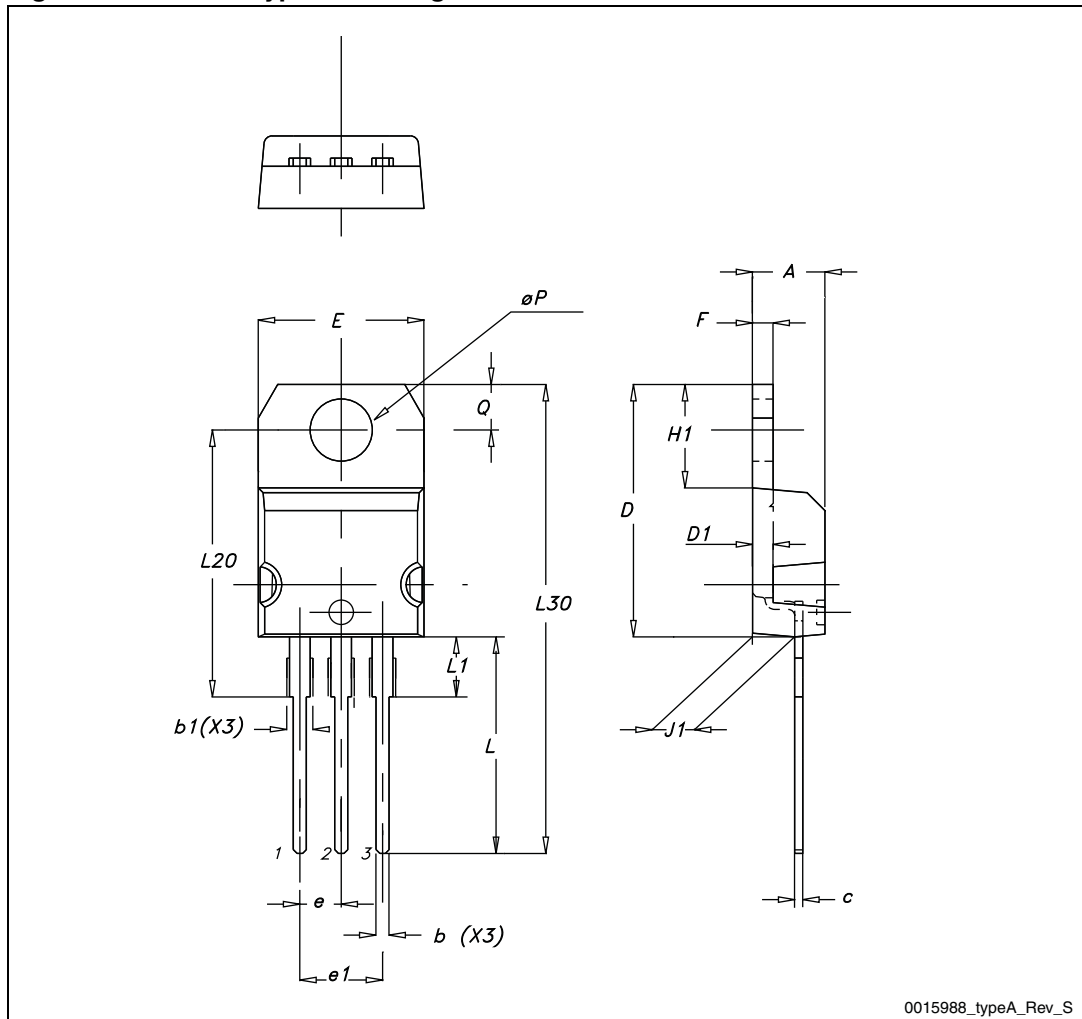
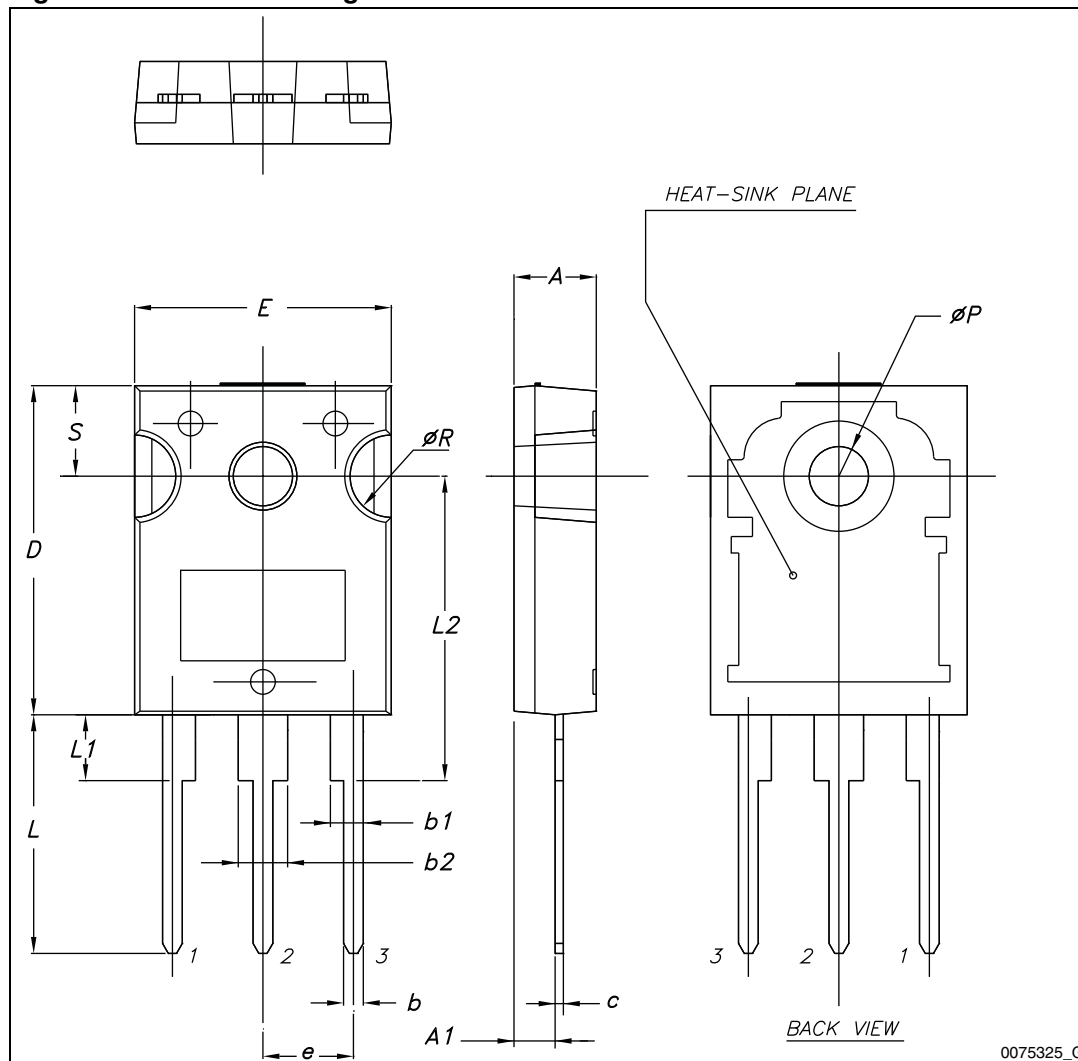

Table 11. TO-247 mechanical data

Dim.	mm.		
	Min.	Typ.	Max.
A	4.85		5.15
A1	2.20		2.60
b	1.0		1.40
b1	2.0		2.40
b2	3.0		3.40
c	0.40		0.80
D	19.85		20.15
E	15.45		15.75
e	5.30	5.45	5.60
L	14.20		14.80
L1	3.70		4.30
L2		18.50	
ØP	3.55		3.65
ØR	4.50		5.50
S	5.30	5.50	5.70

Figure 27. TO-247 drawing



5 Revision history

Table 12. Document revision history

Date	Revision	Changes
15-Apr-2009	1	First release.
02-Aug-2010	2	Document status promoted from preliminary data to datasheet. Inserted Section 2.1: Electrical characteristics (curves) .
14-Nov-2012	3	Figure 13: Capacitance variations and Figure 14: Gate charge vs gate-source voltage have been corrected. Minor text changes.

Please Read Carefully:

Information in this document is provided solely in connection with ST products. STMicroelectronics NV and its subsidiaries ("ST") reserve the right to make changes, corrections, modifications or improvements, to this document, and the products and services described herein at any time, without notice.

All ST products are sold pursuant to ST's terms and conditions of sale.

Purchasers are solely responsible for the choice, selection and use of the ST products and services described herein, and ST assumes no liability whatsoever relating to the choice, selection or use of the ST products and services described herein.

No license, express or implied, by estoppel or otherwise, to any intellectual property rights is granted under this document. If any part of this document refers to any third party products or services it shall not be deemed a license grant by ST for the use of such third party products or services, or any intellectual property contained therein or considered as a warranty covering the use in any manner whatsoever of such third party products or services or any intellectual property contained therein.

UNLESS OTHERWISE SET FORTH IN ST'S TERMS AND CONDITIONS OF SALE ST DISCLAIMS ANY EXPRESS OR IMPLIED WARRANTY WITH RESPECT TO THE USE AND/OR SALE OF ST PRODUCTS INCLUDING WITHOUT LIMITATION IMPLIED WARRANTIES OF MERCHANTABILITY, FITNESS FOR A PARTICULAR PURPOSE (AND THEIR EQUIVALENTS UNDER THE LAWS OF ANY JURISDICTION), OR INFRINGEMENT OF ANY PATENT, COPYRIGHT OR OTHER INTELLECTUAL PROPERTY RIGHT.

UNLESS EXPRESSLY APPROVED IN WRITING BY TWO AUTHORIZED ST REPRESENTATIVES, ST PRODUCTS ARE NOT RECOMMENDED, AUTHORIZED OR WARRANTED FOR USE IN MILITARY, AIR CRAFT, SPACE, LIFE SAVING, OR LIFE SUSTAINING APPLICATIONS, NOR IN PRODUCTS OR SYSTEMS WHERE FAILURE OR MALFUNCTION MAY RESULT IN PERSONAL INJURY, DEATH, OR SEVERE PROPERTY OR ENVIRONMENTAL DAMAGE. ST PRODUCTS WHICH ARE NOT SPECIFIED AS "AUTOMOTIVE GRADE" MAY ONLY BE USED IN AUTOMOTIVE APPLICATIONS AT USER'S OWN RISK.

Resale of ST products with provisions different from the statements and/or technical features set forth in this document shall immediately void any warranty granted by ST for the ST product or service described herein and shall not create or extend in any manner whatsoever, any liability of ST.

ST and the ST logo are trademarks or registered trademarks of ST in various countries.

Information in this document supersedes and replaces all information previously supplied.

The ST logo is a registered trademark of STMicroelectronics. All other names are the property of their respective owners.

© 2012 STMicroelectronics - All rights reserved

STMicroelectronics group of companies

Australia - Belgium - Brazil - Canada - China - Czech Republic - Finland - France - Germany - Hong Kong - India - Israel - Italy - Japan - Malaysia - Malta - Morocco - Philippines - Singapore - Spain - Sweden - Switzerland - United Kingdom - United States of America

www.st.com

