

PLUG

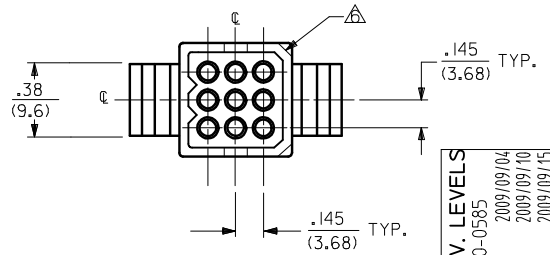

3	S
2	S
1	S
SHT. REV.	

UPDATE REV. LEVELS EC NO: UCP2010-0585 DRWN: RBENES 2009/09/04 CHKD: JELL 2009/09/10 APPR: FSMITH 2009/09/15	QUALITY SYMBOLS ▽=0 ▽=0	GENERAL TOLERANCES (UNLESS SPECIFIED)		DIMENSION STYLE IN/MM	SCALE 1:1	DESIGN UNITS INCH	THIRD ANGLE PROJECTION		
		4 PLACES ± --- ± --- 3 PLACES ± --- ± .010 2 PLACES ± 0.25 ± .014 1 PLACE ± 0.36 ± ---	DRAWN BY JJS	DATE 1988/02/05	TITLE .062/(157) HOUSINGS PLUG & RECEPTACLE 9 CKT., .145/(3.68) CTRS				
		ANGULAR ± 1/2°	CHECKED BY RW	DATE 1988/02/05	MOLEX INCORPORATED				
		DRAFT WHERE APPLICABLE MUST REMAIN WITHIN DIMENSIONS	APPROVED BY RAS	DATE 1988/02/05	MATERIAL NO. SEE CHART	DOCUMENT NO. SD-1625-9*	SHEET NO. 1 OF 3	THIS DRAWING CONTAINS INFORMATION THAT IS PROPRIETARY TO MOLEX INCORPORATED AND SHOULD NOT BE USED WITHOUT WRITTEN PERMISSION	

13

12

11

10

9

8

7

6

5

4

3

2

1

J
I
H
G
F
E
D
C
B
A

J
I
H
G
F
E
D
C
B
A

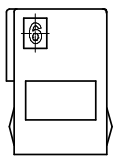
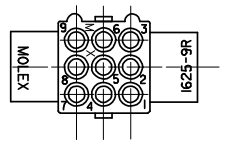

OPTIONAL MOUNTING EARS
SEE DETAIL 3 OR 4
FOR VERSIONS AVAILABLE

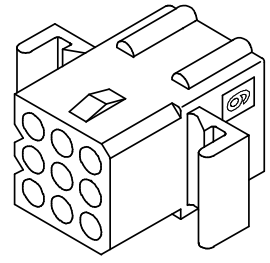
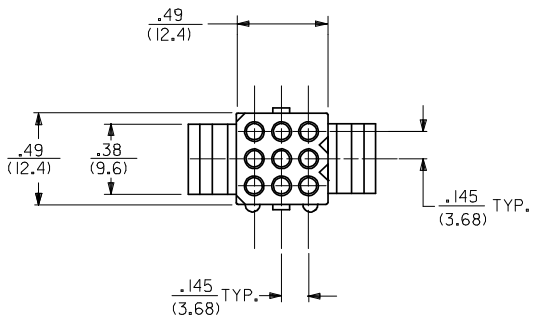
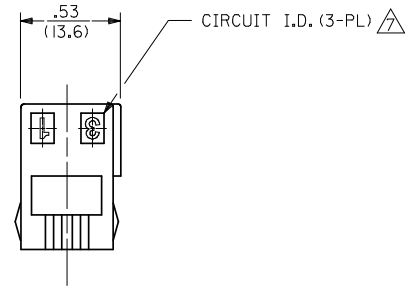
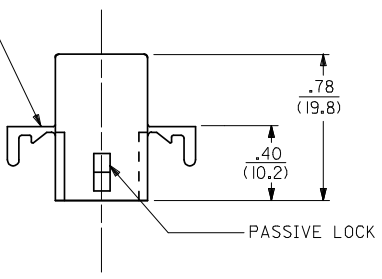

RECEPTACLE

INITIAL RELEASE EC NO: UCP2008-2420 DRAWN: PRIDDER 2008/04/10 CHKD: LSCHMIDT 2008/04/16 APPR: FSMITH 2008/04/24	DESCRIPTION REV A	QUALITY SYMBOLS ▼=0 ▽=0	GENERAL TOLERANCES (UNLESS SPECIFIED) mm INCH 4 PLACES ±.--- ±.--- 3 PLACES ±.--- ±.010 2 PLACES ±0.25 ±.014 1 PLACE ±0.36 ±.--- ANGULAR ±1/2°	DIMENSION STYLE IN/MM	SCALE 2:1	DESIGN UNITS INCH	THIRD ANGLE PROJECTION
		DRAWN BY AELHAG	DATE 2008/04/07	TITLE .062/(1.57) HOUSINGS, PLUG AND RECEPTACLE, 9 CKT., .145/(3.68) CTRS			
		CHECKED BY LSCHMIDT	DATE 2008/04/07	MOLEX INCORPORATED			
		APPROVED BY FSMITH	DATE 2008/04/07	MATERIAL NO. SEE CHART	DOCUMENT NO. SD-1625-9**	SHEET NO. 2 OF 3	
DRAFT WHERE APPLICABLE MUST REMAIN WITHIN DIMENSIONS			THIS DRAWING CONTAINS INFORMATION THAT IS PROPRIETARY TO MOLEX INCORPORATED AND SHOULD NOT BE USED WITHOUT WRITTEN PERMISSION				

12

11

10

9

8

7

6

5

4

3

2

1